

OpenAir[®] GPC Series

Spring Return, 35 lb-in (4 Nm), Rotary Electronic Damper Actuators



Description

The OpenAir GPC Series direct-coupled spring return electronic actuator is designed for modulating, two-position, and floating control of building HVAC dampers.

Features

- Bi-directional spring return (fail-safe)
- Pre-cabled
- Plenum-rated models available
- Optional built-in auxiliary switches with fixed switch points at 5° and 85° rotation
- Control signal selectable 0 to 10 Vdc or 2 to 10 Vdc
- 60-second run time
- 35 lb-in (4 Nm) torque
- Signal inversion capability on modulating types (0(2) to 10 Vdc or 10 to 0(2) Vdc)
- UL and cUL listed, CE certified
- Compact footprint
- Low voltage models are 24 Vac/dc compatible
- New line voltage models, 100 to 240 Vac compatible.
- Integrated 1/2" NPT conduit connection

Application

Used in small HVAC dampers and economizer dampers, and constant or variable air volume installations for the control of return air, mixed air, exhaust, and face and bypass, and residential zone dampers requiring up to 35 lb-in (4 Nm) torque.



Designed for applications that require the damper to return to a fail-safe position when there is a power failure.

Product Numbers

Table 1.

Product Number*	Torque			Voltage			Control Signals			Plenum Cabling	Appliance Cable	Auxiliary Switch
	35 lb-in	24 Vac/dc	100 to 240 Vac	2-Position	Floating	Modulating 0(2) to 10 Vdc/10 to 0(2) Vdc	Feedback 0(2) to 10 Vdc/10 to 0(2) Vdc					
GPC121.1P	●	●	—	●	—	—	—	●	—	—		
GPC126.1P	●	●	—	●	—	—	—	●	—	●		
GPC131.1P	●	●	—	—	●	—	—	●	—	—		
GPC136.1P	●	●	—	—	●	—	—	●	—	●		
GPC161.1P	●	●	—	—	—	●	●	●	—	—		
GPC166.1P	●	●	—	—	—	●	●	●	—	●		
GPC321.1U	●	—	●	●	—	—	—	—	●	—		
GPC326.1U	●	—	●	●	—	—	—	—	●	—		

Warning/Caution Notations

WARNING:		Personal injury or loss of life may occur if you do not perform a procedure as specified.
CAUTION:		Equipment damage may occur if you do not perform a procedure as specified.

Actuator Components

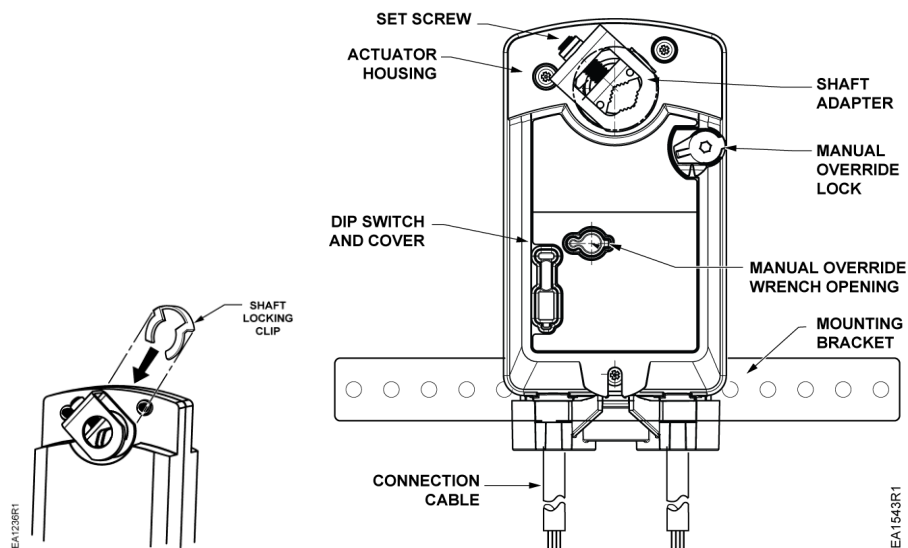

Figure 1. Components of the GPC Spring Return Actuator.

Specifications	Operating voltage	24 Vac \pm 20%, 24 Vdc \pm 20%	
		100 and 240 Vac -15% + 10%	
Power Supply	Frequency	50/60 Hz	
	Power consumption	Running	Holding
	GPC12x @ 24 Vac, 60 Hz	3.4 VA (2.0W)	2.6 VA (1.6W)
	GPC13x @ 24 Vac, 60 Hz	3.5 VA (2.1W)	2.8 VA (1.7W)
	GPC16x @ 24 Vac, 60 Hz	3.5 VA (2.1W)	2.8 VA (1.6W)
GPC32x @ 120 Vac, 60 Hz	4.6 VA (2.4W)	3.5 VA (1.7W)	
Equipment Rating	24 Vac/Vdc	Class 2, in accordance with UL/CSA	
	100 to 240 Vac	Class III per IEC 60536 Double insulation	
Auxiliary Switch Rating	Fixed dual end switches AC rating	24 Vac to 250 Vac/24 Vdc 6A resistive/2 FLA/12 LRA	

Specifications, Continued

Control Signal	Input signal (wires 8–2) voltage input signal (GPC16x.1P) input resistance	0(2) to 10 Vdc (max. 35 Vdc) >100K ohms
Feedback Signal	Position output signal (wires 9–2) voltage output signal (GPC16x.1P) maximum output current	0(2) to 10 Vdc ±1 mA
Function	Running/spring return torque Maximum torque Runtime for 90° operating with motor closing (on power loss) with spring return	35 lb-in (4 Nm) 88 lb-in (10 Nm) 60 seconds 15 seconds typical
Mounting	Nominal angle of rotation Maximum angular rotation Shaft size Minimum shaft length	90° 95° 3/8 to 1/2-inch (8 to 13 mm) dia. 1/4 to 7/16-inch (6 to 11 mm) square 3/4-inch (20 mm)
Housing	Enclosure Material Gear lubrication	NEMA 1 IP54 Plenum-rated rugged plastic Silicone-free
Ambient Conditions	Ambient temperature operation storage and transport Ambient humidity (non-condensing)	–25°F to 130°F (–32°C to 55°C) –40°F to 158°F (–40°C to 70°C) 95% rh
Agency Certification		UL listed per UL 60730 cUL to CSA 60730
	NOTE:	These devices were approved for installation in plenum areas by Underwriters Laboratories, Inc. (UL) per UL 2043.
CE Conformity		EMC, ROHS2 and Low Voltage Directives
FCC Conformity		Part 15 Class B Emissions
Australia Conformity		RCM Requirements
Miscellaneous	Pre-cabled connection Cable length Life cycle Dimensions Weight	18 AWG (0.75 mm ²) 3 feet (0.9 m) length Designed for minimum of 100,000 full stroke cycles and a minimum of 5 million repositions at rated torque and temperature 5.61" H × 2.83" W × 2.48" D (142.6 mm H × 72 mm W × 63 mm D) 1.32 lbs. (0.60 kg)

Accessories

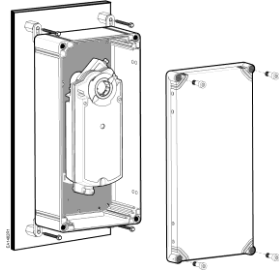

Figure 2. NEMA Type 4X Weather Shield.

ASK75.7U: GPC Actuators are UL listed to meet NEMA Type 4X requirements (a degree of protection against falling dirt, rain, sleet, snow, windblown dust, splashing water, hose-directed water, corrosion, and damage from external ice formation) when installed with an ASK75.7U Weather Shield and outdoor-rated conduit fittings. This weather shield may be mounted in any orientation.

For dimensions, see Figure 12.

Service Parts

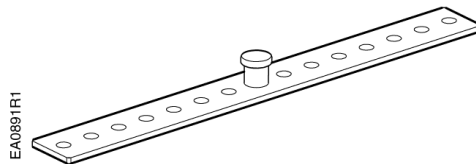

Figure 3. 985-055P24
Anti-rotation Bracket (Mounting).



Figure 4. 985-124
499-ohm Resistor Assembly Kit for
4 to 20 mA Applications.

Operation

GPC16x.1P

Apply a continuous 0(2) to 10 Vdc control signal between wire 8 (Y) and wire 2 (G0) to operate the damper actuator. The angle of rotation is proportional to the control signal.

A 0(2) to 10 Vdc position feedback output signal is available between wire 9 (U) and wire 2 (G0) to monitor the position of the damper motor.

In the event of a power failure or when the operating voltage is shut off, the actuator returns to the "0" position.

GPC 12x.1P and GPC32x.1U

When power is applied, the actuator coupling moves toward the open position "90°". In the event of a power failure or when the operating voltage is shut off, the actuator returns to the "0" position.

GPC13x.1P

A floating control signal controls the damper actuator. The actuator's angle of rotation is proportional to the length of time the signal is applied. A 24 Vac/dc control signal to wire 6 (Y1) causes the actuator coupling to rotate clockwise. A 24 Vac/dc control signal to wire 7 (Y2) causes the actuator coupling to rotate counterclockwise.

With no control voltage, the damper actuator holds its position. In the event of a power failure, the actuator will return to the 0 position.

Overload Protection

In the event of a blockage in the damper, the actuator is overload protected over the full range to prevent damage to the actuator.

Life Expectancy

An improperly tuned loop will cause excessive repositioning that will shorten the life of the actuator.

Sizing

The type of actuator required depends on several factors:

1. Obtain damper torque ratings (lb-in/ft² or Nm/m²) from the damper manufacturer
2. Determine the area of the damper.
3. Calculate the total torque required to move the damper:

$$\text{Total Torque} = \frac{\text{TorqueRating} \times \text{Damper Area}}{\text{SF}^1}$$

4. Select a spring return actuator using Table 1.

¹ Safety Factor: When calculating the total torque required, a safety factor should be included for unaccountable variables such as slight misalignments, aging of the damper, and so on. A suggested safety factor is 0.80.

Table 2. Sizing.

Total Torque	Actuator
≤20 lb-in (≤2Nm)	GQD
> 20 lb-in < 35 lb-in (> 2 Nm < 4 Nm)	GPC
>35 lb-in ≤ 62 lb-in (>4 Nm ≤ 7 Nm)	GMA
>62 lb-in ≤ 160 lb-in (>7 Nm ≤ 18 Nm)	GCA
>160 lb-in ≤ 320 lb-in (>18 Nm ≤ 36 Nm)	Tandem GCA ASK73.2U* : Tandem mounting bracket with any combination of GCA16x. ASK73.1U* : Tandem mounting bracket for all other GCAx actuators.

***NOTE:** Mechanically coupled actuators must be of the exact same type. Use the correct mounting bracket.

Mounting and Installation

- The shaft adapter can be mounted on either side of the actuator. The actuator mounting orientation and shaft length determine how they will be mounted on the actuator.
- The minimum damper drive shaft length is 3/4-inch (20 mm).
- See *Specifications* for the minimum and maximum damper shaft dimensions.
- A mounting bracket is included with the actuator.
- See the detailed installation instructions included with each actuator.

Auxiliary Switches

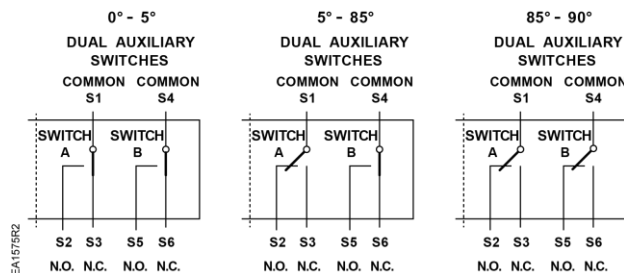

Switch	Switch Makes	Switch Breaks
A (fixed 5°)	< 5°	> 5°
B (fixed 85°)	> 85°	< 85°

NOTE: Both sets of contacts are open when actuator is between 5° and 85°. Switches may be wired in a Normally Closed or Normally Open position.



CAUTION:

Mixed switch operation to the switching outputs of both dual end switches (5° and 85°) is not permitted.

Either AC line voltage from the same phase must be applied to all four outputs of the fixed dual end switches, or UL-Class 2 voltage must be applied to all four outputs.

**DIP Switch
 Functionality
 GPC 161**

NOTE: The black position indicates the active switch setting.









Description	Label		Description	Function
2 to 10 Vdc			0 to 10 Vdc	Control signal selection
				Not In Use
Inverse Acting 			Direct-Acting	Input signal inversion

Figure 5. DIP Switches.

Control Signal Selection Selects the control and feedback signals

Input Signal Inversion Allows inverting the control input signal
 The arrow direction indicates opening or closing (closing or opening) when operating an actuator with a given control signal.

 = Direct acting (Factory setting)
 Input signal 0 Vdc ► fail-safe position

 = Inverse acting
 Input signal 10 Vdc ► fail-safe position

Wiring

All wiring must conform to NEC and local codes and regulations.

Use earth ground isolating step-down Class 2 transformers. Do not use autotransformers.

The maximum rating for a Class 2 step-down transformer is 100 VA. Determine the supply transformer rating by summing the VA ratings of all actuators and all other components used. It is recommended that one transformer power no more than 10 actuators (or 80% of its VA).



WARNING:

Installations requiring  Conformance:

- All wiring for 24 Vac/dc actuators must only be safety extra-low voltage (SELV) or protective extra-low voltage (PELV) per HD384.
- Use safety transformers per EN61558 with double isolation, designed for 100% duty-cycle for supplying SELV or PELV circuits.
- Over-current protection for supply lines is maximum 10A.

Wire Designations Each wire has the standard symbol printed on it. See Table 3.

Table 3. Wire Designations.

Applicable Actuator	Standard Symbol	Function	Terminal Designations	Color
24 Vac/dc	1	Supply (SP)	G	Red
	2	Neutral (SN)	G0	Black
	6	Control signal clockwise (CW)	Y1	Violet
	7	Control signal counterclockwise (CCW)	Y2	Orange
	8	Input signal: 0(2) to 10 Vdc or 10 to 0(2) Vdc	Y	Gray
	9	Position output: 0(2) to 10 Vdc or 10 to 0(2) Vdc	U	Pink
100 to 240 Vac	3	Supply	L	Brown
	4	Neutral	N	Light Blue
Auxiliary Switches	S1	Switch A – Common	S1	Gray/Red
	S2	Switch A – N.O.	S2	Gray/Blue
	S3	Switch A – N.C.	S3	Gray/Pink
	S4	Switch B – Common	S4	Black/Red
	S5	Switch B – N.O.	S5	Black/Blue
	S6	Switch B – N.C.	S6	Black/Pink

Wiring Diagrams

GPC12x
 24 Vac/dc
 2-Position Control

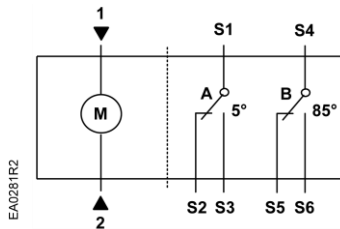

Figure 6.

GPC13x
 24 Vac/dc
 Floating Control

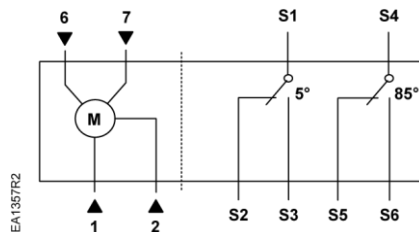
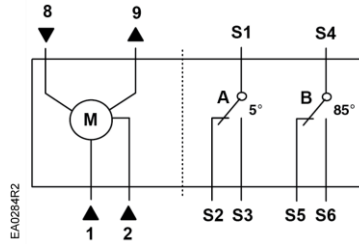

Figure 7.

**Wiring Diagrams,
 Continued**

GPC16x

24 Vac/dc
 Modulating Control



III
 Class III

Figure 8.

GPC32x

100 to 240 Vac
 2-Position Control

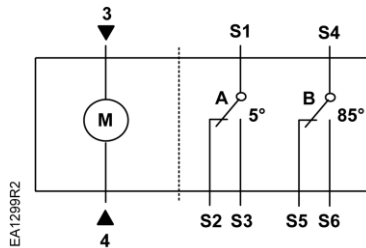

Figure 9.

**Special
 Applications**

GPC16x

4 to 20 mA

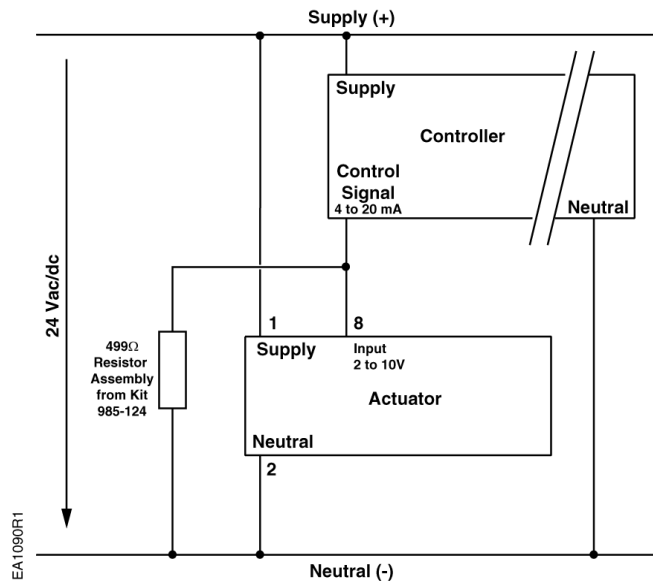

Figure 10. GPC16x 4 to 20 mA Applications.

**Start-Up/
Commissioning****GPC16x****Spring Return
Modulating Control
24 Vac/dc**

1. Check Operation:
 - a. Connect wires 1 (red) and 2 (black) to the 24 Vac/dc power supply.
NOTE: With no input signal present, the GPC16x.1P Actuator with input signal inversion switch set to Inverse Acting, will start driving towards 90°.
 - b. Use a Digital Multimeter (DDM) and set the dial to Vdc for the actuator input signal.
 - c. Connect wires 2 (black) and 8 (gray) to the DMM.
 - d. Apply to input signal wire 8 (gray):
Y = 10 Vdc (GPC16x.1P with input signal inversion switch set to Direct Acting).
Y = 0 Vdc (GPC16x.1P with input signal inversion switch set to Inverse Acting).
Allow the actuator shaft coupling to rotate from 0° to 90°.
 - e. Apply to input signal wire 8 (gray):
Y = 0 Vdc (GPC16x.1P with input signal inversion switch set to Direct Acting).
Y = 10 Vdc (GPC16x.1P with input signal inversion switch set to Inverse Acting).
The shaft coupling returns to the **0** position.
 2. Check Spring Return:
 - a. Set the DMM dial to Vdc.
 - b. Connect wires 2 (black) and 8 (gray) to the DMM.
 - c. Apply to input signal wire 8 (gray):
Y = 5 Vdc (GPC16x.1P).
Allow the actuator shaft coupling to rotate halfway.
 - d. Disconnect wire 1 (red).
The spring returns the actuator shaft coupling to the fail-safe "0" position.
 - e. Connect wire 1 (red) and the actuator moves.
 3. Check Feedback:
 - a. Set the DMM dial to Vdc.
 - b. Attach wires 2 (black) and 9 (pink) to the DMM.
 - c. Apply the input signal as in *Step 1d*, to wire 8 (gray).
 - The reading at the DMM should increase (decrease for GPC16x.1P with output signal inversion switch set to Inverse Acting Feedback).
 - The reading at the DMM should decrease (increase for GPC16x.1P with output signal inversion switch set to Inverse Acting Feedback) and the actuator shaft coupling returns to the fail-safe **0** position.
-

GPC12x**Spring Return
2-Position
24 Vac/dc**

1. Check Operation:
 - a. Connect wires 1 (red) and 2 (black) to 24 Vac/dc power supply.
Allow the actuator shaft coupling to rotate from 0° to 90°.
 - b. Disconnect wire 1 (red) and the actuator shaft coupling returns to the "0" position.
 2. Check Spring Return:
 - a. Connect wire 1 (red).
Allow the actuator shaft coupling to rotate halfway.
 - b. Disconnect wire 1 (red).
The spring returns the actuator shaft coupling to the fail-safe **0** position.
-

GPC13x
Spring Return
Floating
24 Vac/dc

1. Check Operation:
 - a. Connect wires 1 (red) and 2 (black) to a 24 Vac/dc power supply.
 - b. Apply a control signal (24 Vac/dc) to wire 6 (violet).
Allow the actuator shaft coupling to rotate from 0 to 90°.
 - c. Remove the control signal to wire 6 (violet).
 - d. Apply a control signal (24 Vac/dc) to wire 7 (orange).
Allow the actuator shaft coupling to rotate from 90° to 0°.
2. Check Spring Return:
 - a. Apply a control signal (24 Vac/dc) to wire 6 (violet).
Allow the actuator shaft coupling to rotate half way.
 - b. Disconnect wire 1 (red).
The spring returns the actuator shaft coupling to the fail-safe **0** position.
 - c. Connect wire 1 (red).
The actuator shaft coupling begins to move.

GPC32x
Two-Position
100 to 240 Vac

1. Check Operation:
 - a. Switch on 120 Vac power.
 - b. Allow the actuator shaft coupling to rotate from 0 to 90°.
2. Switch off power.
The actuator shaft coupling will return to the **0** position.
3. Check Spring Return:
 - a. Switch on 120 Vac power.
 - b. Allow the actuator shaft coupling to rotate halfway.
 - c. Switch off 120 Vac power.
The spring returns the actuator shaft coupling to the fail-safe **0** position.

Service



WARNING:

Do not open the actuator.
If the actuator is inoperative, replace the unit.

Troubleshooting



WARNING:

To avoid injury or loss of life, pay attention to any hazardous voltage
(For example, 120 Vac) when performing checks.

- Check that the wires are connected correctly.
 - Check that DIP switch is set correctly, if used.
 - Use a Digital Multimeter (DMM) to verify that the operating voltage is within range.
 - If the actuator is not working, check the damper for blockage.
 - If blocked, remove the obstacle and cycle the actuator power off and on. The actuator should resume normal operating mode.
-

Dimensions

In Inches (Millimeters)

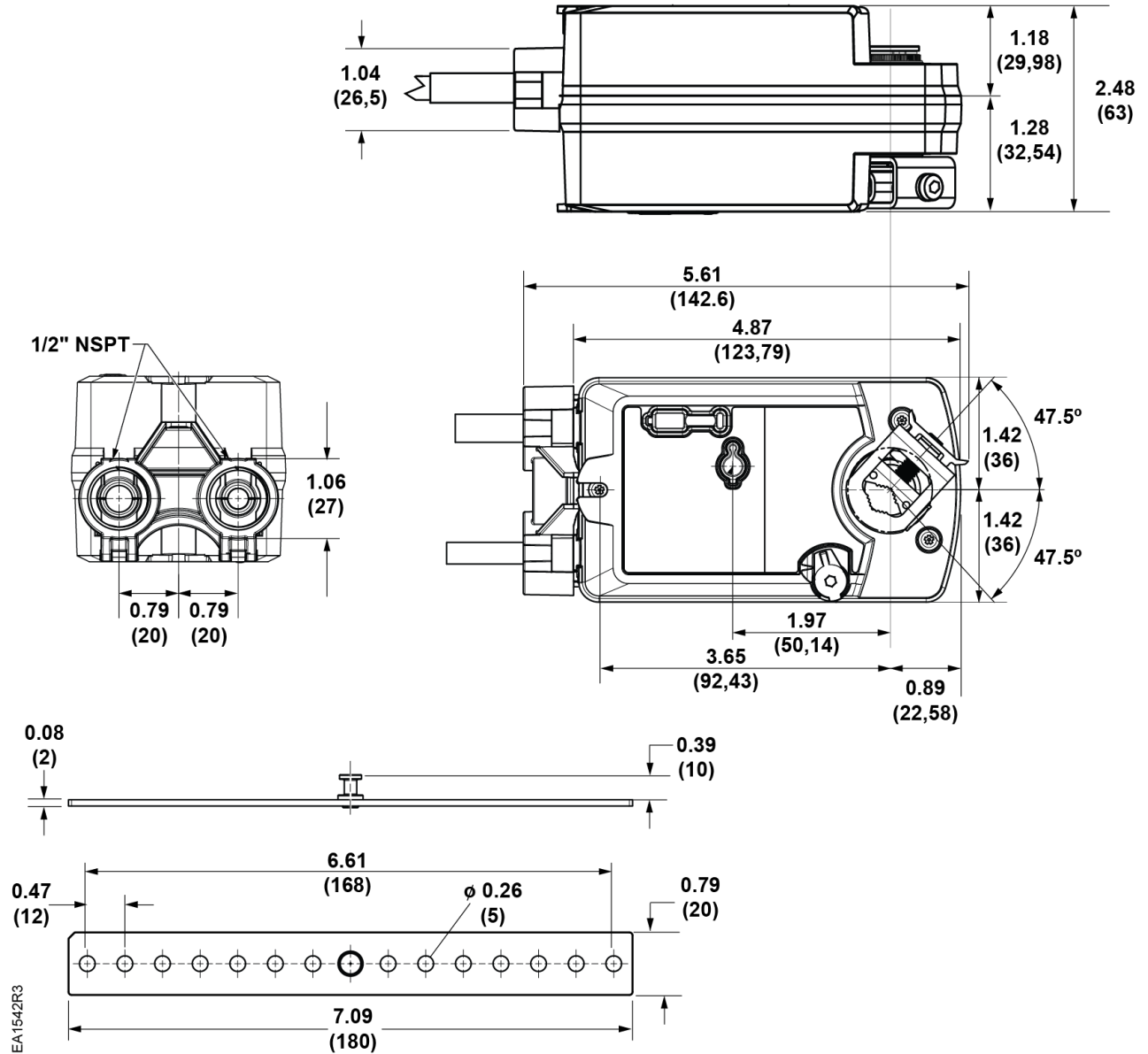

Figure 11. GPC Series Actuators and Mounting Bracket.

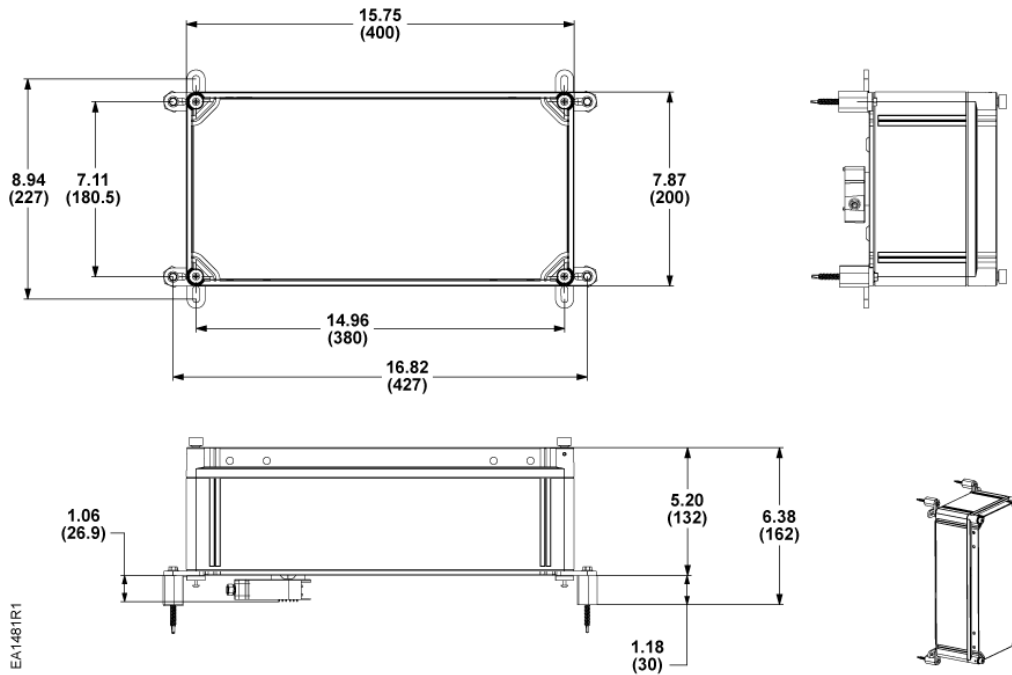

Figure 12. Dimensions of the ASK75.7U Weather Shield in Inches (Millimeters).

Information in this publication is based on current specifications. The company reserves the right to make changes in specifications and models as design improvements are introduced. OpenAir is a registered trademark of Siemens Schweiz AG. Product or company names mentioned herein may be the trademarks of their respective owners. © 2019 Siemens Industry, Inc.