

ACVATIX™

## 2-port and 3-port valves, externally threaded, PN16

VVG44.., VXG44..



**In small and medium-sized heating, ventilating and air conditioning systems as a control valve for mixing and diverting functions or as a shutoff valve. For closed circuits only.**

- Housing made of bronze CC491K (Rg5)
- DN 15...40
- $k_{vs}$  0.25...25 m<sup>3</sup>/h
- Flat sealing, externally threaded connections G..B, as per ISO 228-1
- Siemens can deliver fitting sets ALG.. with threaded connection and ALS.. with welded connection
- Manual adjustment by means of mounted knob
- Can be equipped with motorized SQS.. and SAS.. actuators

**Design**

Valve cross-section:

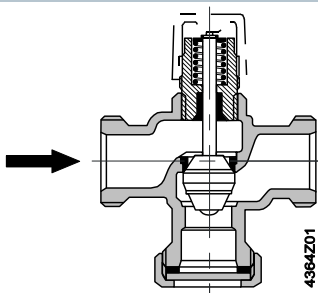
<b>VVG44..</b>	
	<p>Guided parabolic plug, integrated in the valve stem.</p> <p>The seat is pressed to the valve body with the aid of special gland material.</p>
<p>Caution: The 2-port seat valve does not become a three-port valve by removing the cover plate!</p>	

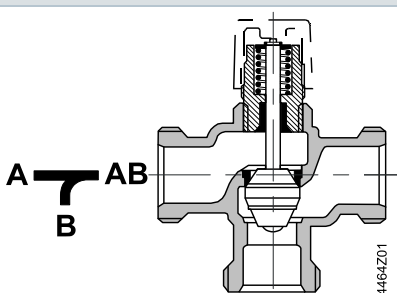
<b>VXG44..</b>	
	<p>Guided parabolic plug (as of DN25) which is integrated in the valve stem.</p> <p>The seat is fitted in the through-port and attached directly to the valve body in the bypass.</p> <p>From DN25, the seat in the through-port is attached directly to the valve body and fitted to the ring in the bypass.</p>

## Sizing

Flow diagram:

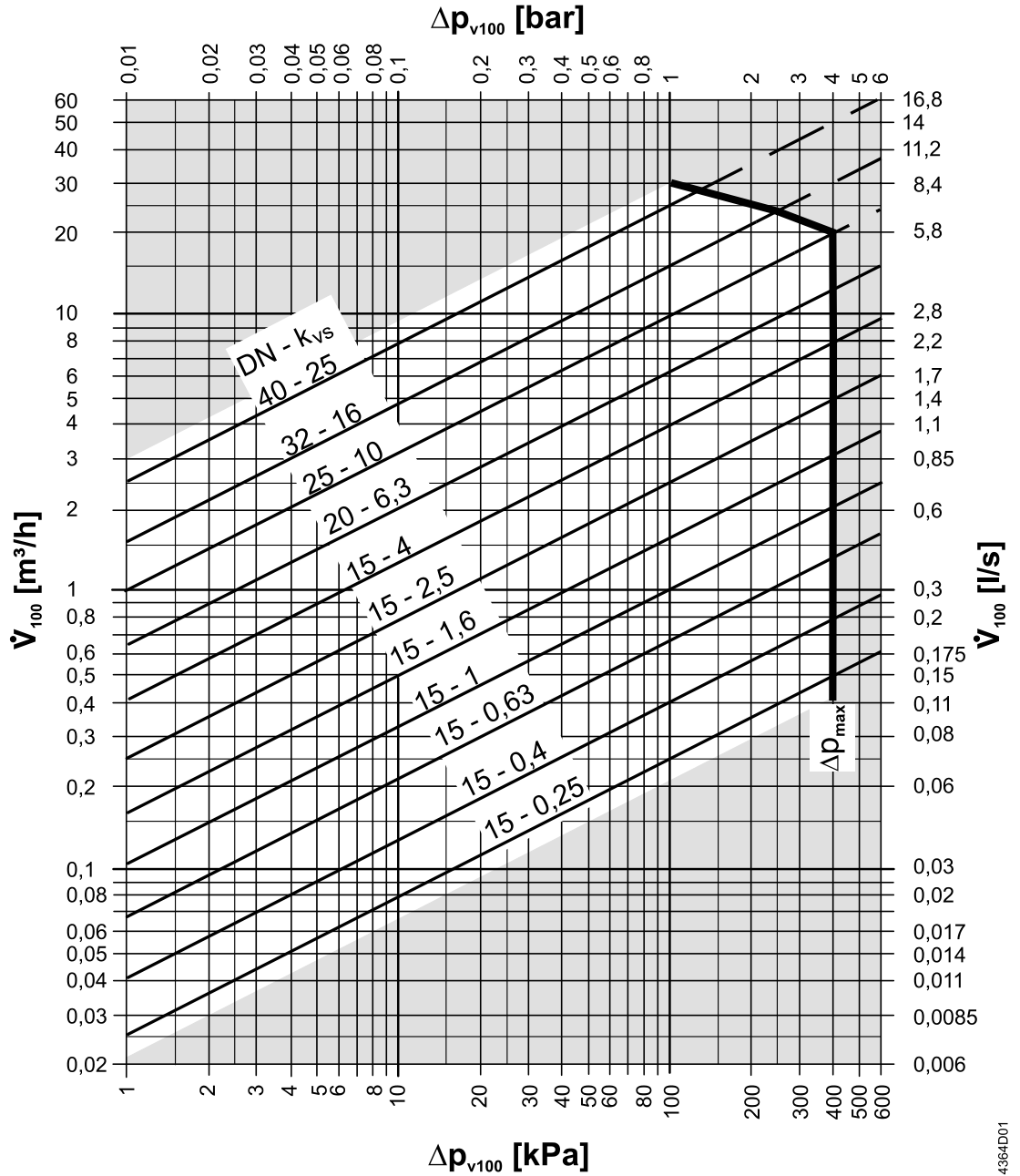

$\Delta p_{\max}$  = Maximum permissible differential pressure across the valve  
(VXG44...: mixing port: Ports A-AB, B-AB, diverting: Ports AB-A, AB-B),  
valid for the entire actuating range valve-actuator unit

$\Delta p_{v100}$  = Differential pressure across the fully open valve and the valve's control  
path  
(VXG44...: A - AB, B - AB) at a volume flow  $\dot{V}_{100}$

$\dot{V}_{100}$  = Volume flow through the fully open valve ( $H_{100}$ )

100 kPa = 1 bar  $\approx$  10 mWS

1 m<sup>3</sup>/h = 0.278 l/s water at 20 °C

4364D01

## Valve flow characteristic

VG44..

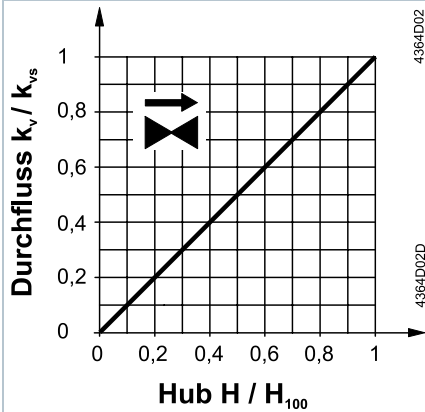

### Valve flow characteristic:

Through-port: 0...100% linear as per VDI / VDE 2173

VXG44..

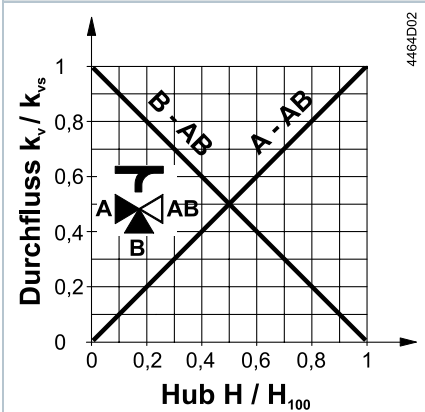

### Valve flow characteristic:

Through-port: Linear as per VDI / VDE2173

Bypass: Linear as per VDI / VDE2173

### Mixing:

Flow from port A and B to port AB

### Diverting:

Flow from port AB to port A and B

Port A = Variable flow

Port B = Bypass (variable flow)

Port AB = Constant flow

Use the three-port valve primarily as a mixing valve.

### Cavitation

Cavitation increases wear and tear on the parabolic plug and seat and results in unwanted noise. Cavitation can be prevented by not exceeding the differential pressures as per the flow diagram and maintaining the static pressures depicted below.

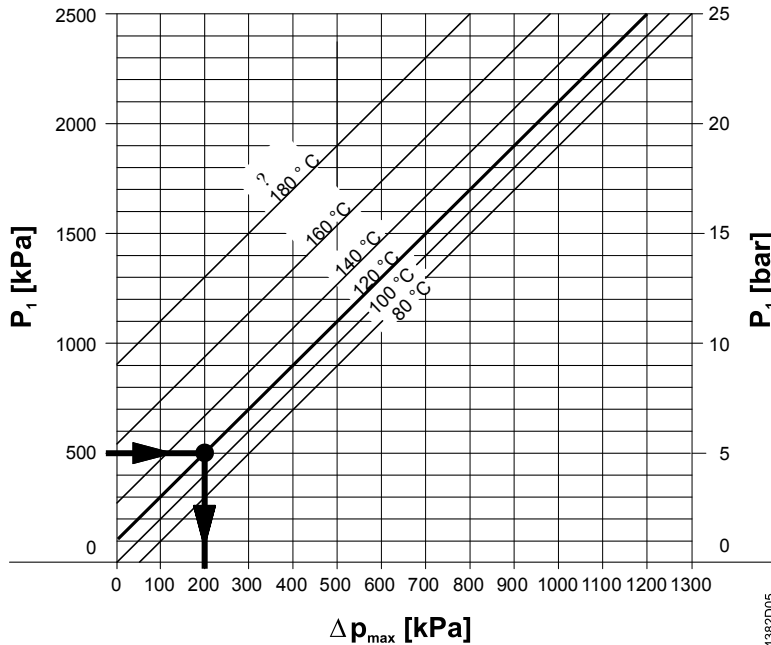

$\Delta p_{max}$  = Differential pressure at a nearly closed valve to largely avoid cavitation

$p_1$  = Static pressure and the valve inlet

$P_3$  = Static pressure and the valve outlet

M Pump

J Water temperature

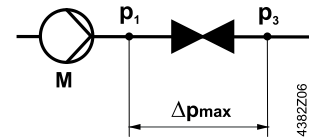

Example with hot water:

Pressure  $p_1$  at valve inlet: 500 kPa (5 bar)

Water temperature: 120 °C

The above diagram clearly indicates that the maximum permissible differential pressure is  $\Delta p_{max} \rightarrow 200$  kPa (2 bar) at a nearly closed valve.

Note on chilled water applications

To prevent cavitation in chilled water circuits, sufficient counter pressure must be supplied to the valve output, e.g. using an additional butterfly valve downstream of the valve. Maximum permissible differential pressure over the valve: See 80 °C curve in the above diagram.

## Operating pressure and operating temperature

Liquids:

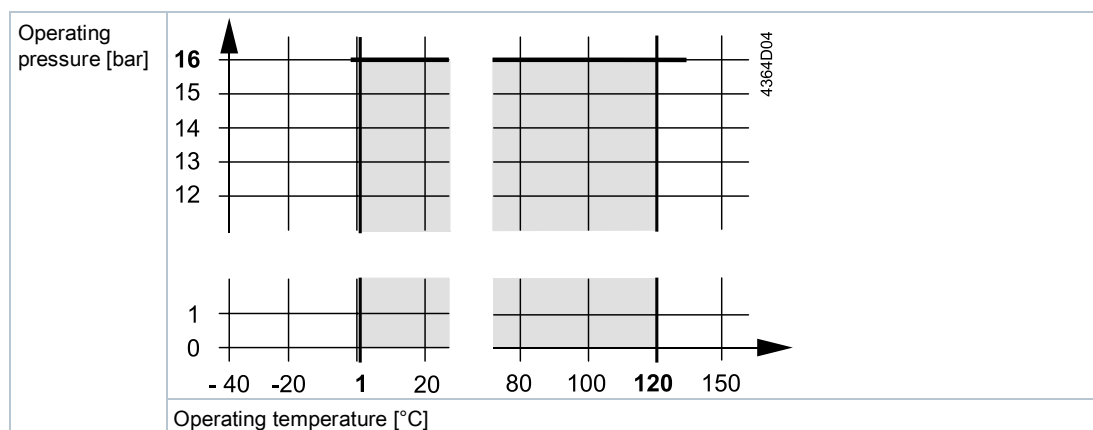

Operating pressure and medium temperature per ISO 7005  
(Observe all local and applicable laws).

### Type summary

Type	DN	$k_{vs}$	$S_v$	
		[m <sup>3</sup> /h]		
VVG44.15-0.25 VXG44.15-0.25	15	0.25	>50	
VVG44.15-0.4 VXG44.15-0.4		0.4		
VVG44.15-0.63 VXG44.15-0.63		0.63		
VVG44.15-1 VXG44.15-1		1		
VVG44.15-1.6 VXG44.15-1.6		1.6		
VVG44.15-2.5 VXG44.15-2.5	20	2.5	>100	
VVG44.15-4 VXG44.15-4		4		
VVG44.20-6.3 VXG44.20-6.3		6.3		
VVG44.25-10 VXG44.25-10		10		
VVG44.32-16 VXG44.32-16		16		
VVG44.40-25 VXG44.40-25		25		
VVG44.20-6.3 VXG44.20-6.3		25		6.3
VVG44.25-10 VXG44.25-10				
VVG44.32-16 VXG44.32-16		32		16
VVG44.40-25 VXG44.40-25				
VVG44.40-25 VXG44.40-25	40	25		
VVG44.40-25 VXG44.40-25				

- DN = Nominal size
- $k_{vs}$  = Flow nominal value for cold water (5...30 °C) through a fully opened valve (H100), at a differential pressure of 100 kPa (1 bar)
- $S_v$  = Rangeability  $k_{vs} / k_{vr}$
- $k_{vr}$  = Smallest  $k_v$  value at which the characteristic curve tolerance is still maintained, at a differential pressure of 100 kPa (1 bar)

**Fittings**

Type	Stock number	Description
ALG..2	BPZ:ALG..2	2 piece fittings set for 2-port valves, existing of 2 cap nuts, 2 insert nuts, and 2 flat seals. ALG..2B are fittings made of brass for media temperatures up to 100 °C
ALG..2B	S55846-Z1..	
ALG..3	BPZ:ALG..3	3 piece fittings set for 3-port valves, existing of 3 cap nuts, 3 insert nuts, and 3 flat seals. ALG..3B are fittings made of brass for media temperatures up to 100 °C
ALG..3B	S55846-Z1..	
ALS..2	BPZ:ALS..	2 piece on pipe fittings set with welded connection for 2-port valves, existing of 2 cap nuts, 2 insert nuts, and 2 flat seals

**Filter**

Installed upstream of the valve:

Type	Stock number	Description	DN	Mesh width [mm]
ALX15	S55845-Z174	Filter with internal threading	15	0.5
ALX20	S55845-Z175	Filter with internal threading	20	0.8
ALX25	S55845-Z176	Filter with internal threading	25	0.8
ALX32	S55845-Z177	Filter with internal threading	32	0.8
ALX40	S55845-Z178	Filter with internal threading	40	0.8
ALX50	S55845-Z179	Filter with internal threading	50	0.8

## Equipment combinations

Valves	SQS.. and SAS.. actuators	
	Dp <sub>max</sub> Mixing <sup>1)</sup>	Dp <sub>s</sub> Diverting <sup>1)</sup>
	[kPa]	[kPa]
VVG44.15-0.25	400	1600
VVG44.15-0.4		
VVG44.15-0.63		
VVG44.15-1		725
VVG44.15-1.6		
VVG44.15-2.5		
VVG44.15-4		400
VVG44.20-6.3		
VVG44.25-10		
VVG44.32-16	250	250
VVG44.40-25	125	125
VXG44.15-0.25	400	100
VXG44.15-0.4		
VXG44.15-0.63		
VXG44.15-1		
VXG44.15-1.6		
VXG44.15-2.5		
VXG44.15-4		
VXG44.20-6.3		
VXG44.25-10		
VXG44.32-16		250
VXG44.40-25	125	35

<sup>1)</sup> = Three-port valves only: If noise is permitted, the same values apply as for a mixing valve



Valves	Fittings set			
	Threaded connection			Welded connection
	Malleable cast iron	Brass <sup>1)</sup>		Steel
	Type / Item NO.	Type	Item NO.	Type / Item NO.
VVG44.15-0.25	ALG152	ALG152B	S55846-Z100	ALS202
VVG44.15-0.4				
VVG44.15-0.63				
VVG44.15-1				
VVG44.15-1.6				
VVG44.15-2.5				
VVG44.15-4				
VVG44.20-6.3	ALG202	ALG202B	S55846-Z102	ALS252
VVG44.25-10	ALG252	ALG252B	S55846-Z104	-
VVG44.32-16	ALG322	ALG322B	S55846-Z106	-
VVG44.40-25	ALG402	ALG402B	S55846-Z108	-
VXG44.15-0.25	ALG153	ALG153B	S55846-Z101	-
VXG44.15-0.4				
VXG44.15-0.63				
VXG44.15-1				
VXG44.15-1.6				
VXG44.15-2.5				
VXG44.15-4				
VXG44.20-6.3	ALG203	ALG203B	S55846-Z103	-
VXG44.25-10	ALG253	ALG253B	S55846-Z105	-
VXG44.32-16	ALG323	ALG323B	S55846-Z107	-
VXG44.40-25	ALG403	ALG403B	S55846-Z109	-

<sup>1)</sup> = Medium temperature: Maximal 100 °C

$\Delta p_{max}$  = Maximum permissible differential pressure over the valve control path, valid for the entire positioning range of the valve-actuator unit; if low noise operation is desired, we recommend a differential pressure of 200 kPa

$\Delta p_s$  = Maximum permissible differential pressure (closing pressure) at which the valve-actuator unit securely closes against the pressure

## Actuators: Overview

Type	Operating voltage	Positioning		Spring return		Data sheet
		Signal	Time	Function	Time	
SQS35.00	AC 230 V	3-position	150 s	-	-	N4573
SQS35.03			35 s			
SQS35.50			150 s	Yes	8 s	
SQS35.53			35 s			
SQS65.5	AC 24 V	DC 0...10 V 0...1000 Ω	35 s	-	-	
SQS65						
SQS65.2		DC 2...10 V 0...1000 Ω	150 s			
SQS85.00				3-position		
SQS85.03		35 s				
SAS31.00	AC 230 V	3-position	120 s	-	-	N4581
SAS31.03			30 s			
SAS31.50			120 s	Yes	< 28 s	
SAS31.53			30 s	Yes	< 14 s	
SAS61.03 <sup>1)</sup>	AC/DC 24 V	DC 0...10 V DC 4...20 mA 0...1000 Ω	30 s	-	-	
SAS61.03U <sup>2)</sup>						
SAS61.33 <sup>1)</sup>				Yes	< 14 s	
SAS61.33U <sup>2)</sup>						
SAS61.53 <sup>1)</sup>						
SAS81.00 <sup>1)</sup>	AC/DC 24 V	3-position	120 s	-	-	
SAS81.00U <sup>2)</sup>			30 s			
SAS81.03 <sup>1)</sup>				Yes	< 14 s	
SAS81.03U <sup>2)</sup>						
SAS81.33 <sup>1)</sup>						
SAS81.33U <sup>2)</sup>						

<sup>1)</sup> Approbation CE+UL

<sup>2)</sup> Approbation CE+UL, cable gland: ½" (UL514C)

## Ordering

Please indicate material, article type, order text, and quantity; example:

Material	Article type	Order text	Quantity
VVG44.25-10	VVG44.25-10	Valve.	3
ALG252B	S55846-Z104	Fitting sets	3

## Delivery

Valves, rotary actuators, and mounting kits are not assembled and are delivered in individual packaging and without a minimum order size.

## Product documentation

Related documents such as environmental declarations, CE declarations, etc., can be downloaded at the following Internet address:

<http://siemens.com/bt/download>

Safety

	<p><b>⚠ DANGER</b></p>
	<p><b>There is a risk to operating personnel and device when working on the unit</b>                  Failure to comply with these safety notes can result in personal injury and damage to property from pipe pressure, electrical voltage, or device in operation.</p> <p>▷ Note the following when servicing a valve/actuator:</p> <ul style="list-style-type: none"> <li>• Switch off both pump and operating voltage.</li> <li>• Close shutoff valves.</li> <li>• Release pressure in the pipes and allow them to cool down completely.</li> <li>• Disconnect electrical connections from the terminals as needed.</li> <li>• The actuator must be properly installed or manually adjusted prior to recommissioning the valve.</li> </ul>

	<p><b>⚠ CAUTION</b></p>
	<p><b>National safety regulations</b>                  Failure to comply with national safety regulations may result in personal injury and property damage.</p> <ul style="list-style-type: none"> <li>• Observe national provisions and comply with the appropriate safety regulations.</li> </ul>

Engineering

We recommend installing the valve with spring return since temperatures are lower on heating plants which increases the lifespan of the sealing gland on the stem.  
 A filter must be installed upstream of the valve to increase functional safety.

Mounting

It is easy to assemble the valve and actuator; it can be done at the construction site. No special tools or settings required.  
 Valve VVG44.. / VXG44.. is supplied with Mounting instructions M4364 (4 319 9564 0).

Mounting position

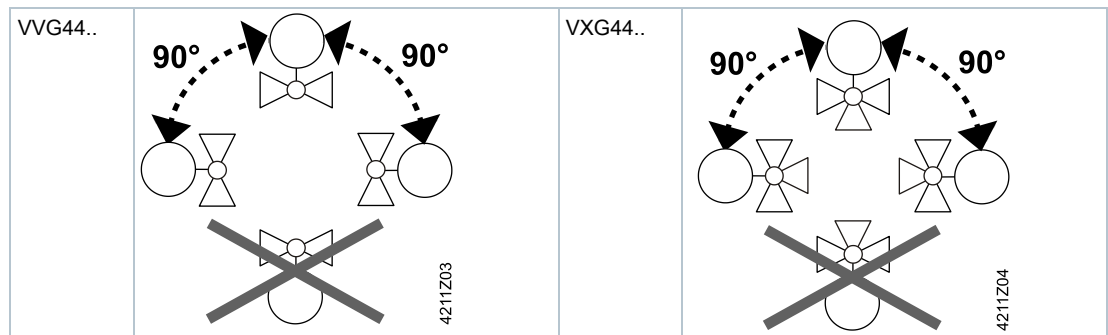

### Pipe connection



Avoid leakage:

- Install fittings as per ISO 7-1.
- Do not use too much hemp or PTFE tape.
- Do not tighten pipe threading to "the very end".

### Flow direction

Make sure that the valve is mounted in the proper flow direction. A symbol is applied to the valve body:

<b>VVG44.. :</b>	
Flow direction:	

<b>VXG44.. :</b>			
Mixing A / B to AB:		Diverting AB to A / B:	

## Commissioning

The actuator must be properly mounted or manually adjusted before commissioning the valve.

<b>VVG44..</b>	
Turn the manual adjuster clockwise:	Valve opening = Increasing flow
Turn the manual adjuster counter clockwise:	Valve closing = Decreasing flow

<b>VXG44..</b>	
Turn the manual adjuster clockwise:	Through-put A – AB opens, bypass B closes
Turn the manual adjuster counter clockwise:	Through-put A – AB closes, bypass B opens

## Maintenance

Valves VVG44.. and VXG44.. are maintenance free.

### Stem sealing gland

The stem sealing gland cannot be exchanged. The entire valve must be replaced in the event of leakage. Contact your local Siemens office or branch for information.

## Disposal

	<p>The valve is considered an electronics device for disposal in terms of European Directive 2012/19/EU and may not be disposed of as domestic garbage.</p> <ul style="list-style-type: none"> <li>• Disassemble the valve into individual parts prior to disposing of it and sort the individual parts by the various types of materials.</li> <li>• Comply with all local and currently applicable laws and regulations.</li> </ul>
---	---

## Warranty

Technical data on specific applications are valid only together with Siemens products listed under "Equipment combinations". Siemens rejects any and all warranties in the event that third-party products are used.

Functional data		
	VVG44..	VXG44..
PN class	PN 16 per ISO 7268	
Operating pressure	Per ISO 7005 within the permissible media temperature as per Section Technical design [→ 2]	
Characteristic curve 0...100 %	linear as per VDI / VDE 2173	
Leakage rate	0...0.02 % of $k_{vs}$ value per DIN EN 1349	0...0.02 % of $k_{vs}$ value per DIN EN 1349 (through-put and bypass)
Permissible media	Chilled water, hot water, water with frost temperature. Recommendation: Water treatment per VDI 2035	
Medium temperature <sup>1)</sup>	1...120 °C	
Rangeability $S_v$	DN 15: >50 or >100, see Section Type overview [→ 6] DN ≥20: >100	
Nominal stroke	5.5 mm	
Rotational angle	90 °	

Materials	
Housing	Bronze CC491K (Rg5)
Seat in through-put	CrNi steel, bronze Rg5 or Messing
Seat in bypass (VXG44.. only)	Bronze Rg5 or brass
Plug	CrNi steel or brass
Stem	CrNi steel
Sealing gland	Brass
Gland materials	EPDM-O rings

Dimensions / Weight	
See Dimensions [→ 14]	
Connections with external threading	G..B per ISO 228-1
Actuator fixing	G ¾"

Standards, directives and approvals	
Pressure Equipment Directive	DGR 2014/68/EU
Pressure accessories	Range: Article 1, para. 1 Definition: Article 2, para. 5
Fluid group 2	Without CE certification as per article 3, para. 3 (generally applicable engineering practice) <sup>2)</sup>
EAC compliance	Eurasian compliance
Environmental compatibility	Environmental Declaration CE1E4364en <sup>3)</sup> contains data on environmental-compatible product design and assessment (RoHS compliance, compositions, packaging, environmental benefits and disposal).

<sup>1)</sup> With ALG..B fitting up to 100 °C

<sup>2)</sup> Fittings for a product where PS x DN < 1000, do not require special testing and cannot have CE labeling

<sup>3)</sup> See Section Product documentation [→ 10]

VVG44..

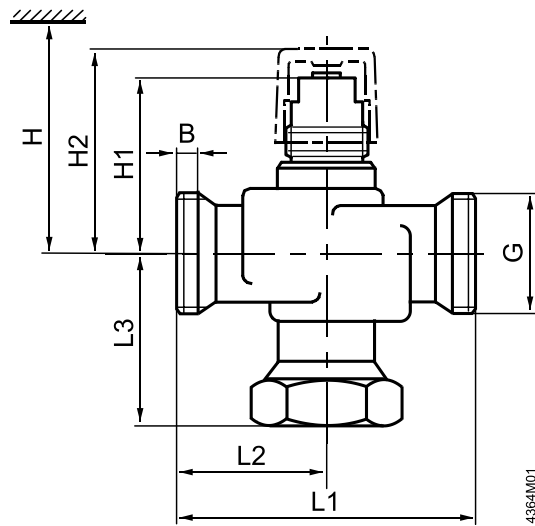

4364M01

VXG44..

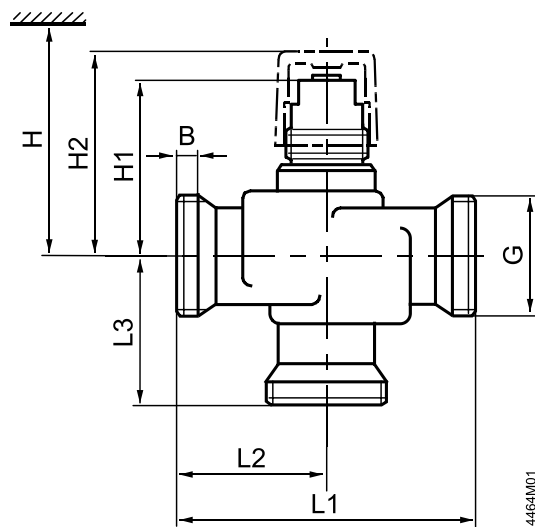

4464M01

DN = Nominal size

H = Total height of actuator plus minimum mounting distance to wall or ceiling, for mounting, connection, operation, maintenance, etc.

H1 = Dimension from the pipe to the center to install actuator (upper edge)

H2 = Pipe center to the upper edge of the manual adjustment button, valve is in the "closed" position

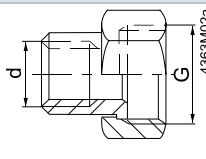

	Type	Article number	For valve type	G	Rp
				[inch]	[inch]
	ALS202	BPZ:ALS202	VVG44.15..	G 1	26.8
	ALS252	BPZ:ALS252	VVG44.20	G 1¼	33.7
	-	-	VVG44.25	-	-
	-	-	VVG44.32	-	-
	-	-	VVG44.40	-	-

## Filter

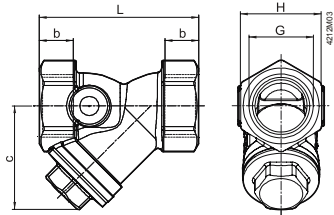
	Type	DN	b	c	G	L	H	K <sub>vs</sub>	Weight
			mm	mm	Inch <sup>1)</sup>	mm	mm		kg
	ALX15	15	12	38	G ½	54	27	3.5	0.178
	ALX20	20	15	43	G ¾	67	34	5.8	0.290
	ALX25	25	16	53	G 1	79	41	9.1	0.410
	ALX32	31	17	64	G 1¼	98	51	19	0.680
	ALX40	40	18	70	G 1½	106	57	24	0.874
	ALX50	50	20	85	G 2	122	69	36	1.428

<sup>1)</sup> ISO 228-1

## Replacement parts

Type	Item NO.	Designation	Quantity
74 676 0273 0	74 676 0273 0	Rotary knob for small-stroke valves	10

## Revision numbers

Type	Valid from rev. no.	Type	Valid from rev. no.
<b>VVG44.. 2-port</b>		<b>VXG44.. 3-port</b>	
VVG44.15-0.25	..A	VXG44.15-0.25	..A
VVG44.15-0.4	..A	VXG44.15-0.4	..A
VVG44.15-0.63	..A	VXG44.15-0.63	..A
VVG44.15-1	..A	VXG44.15-1	..A
VVG44.15-1.6	..A	VXG44.15-1.6	..A
VVG44.15-2.5	..A	VXG44.15-2.5	..A
VVG44.15-4	..A	VXG44.15-4	..A
VVG44.20-6.3	..A	VXG44.20-6.3	..A
VVG44.25-10	..A	VXG44.25-10	..A
VVG44.32-16	..A	VXG44.32-16	..A
VVG44.40-25	..A	VXG44.40-25	..A

Issued by  
Siemens Switzerland Ltd  
Building Technologies Division  
International Headquarters  
Gubelstrasse 22  
CH-6301 Zug  
Tel. +41 41-724 24 24  
www.siemens.com/buildingtechnologies

© Siemens Switzerland Ltd, 2016  
Technical specifications and availability subject to change without notice.