



## B3Q660, B3Q680, B3Q685

AlgoRex

## Comfort operating terminals



For fire detection system CS1140 / EP7F

- Context and system state adapted operating functions via Softkeys
- Functionally grouped, ergonomically operating and indicating elements
- Large LC Display:
  - Plain text display with three lines for information messages per alarm event
  - Context-dependent help texts for alarm situations direct on LC Display
  - Additional, spontaneous indication of local, highlighted measures texts
  - Simultaneous indication of several events
- Different user levels depending on user profile
- Operating access via password or key switch for complete system operation
- Several operating terminals can be connected to one fire detection system
- Operating terminal separated from control unit or integrated into control unit housing
- Can also be used as main CPU
- Integrated emergency function / emergency operation
- Options
  - Parallel indicators, synoptic, fire department control panel
  - Lockable Plexiglas door
  - Integrate able LON port for floor control panels

## System overview

Fire detection system:

- max. 16 CI11 per C bus
  - max. 15 CT11 per C bus
  - max. 1 CA11 per CI11/CT11
- see also product data sheet 008722

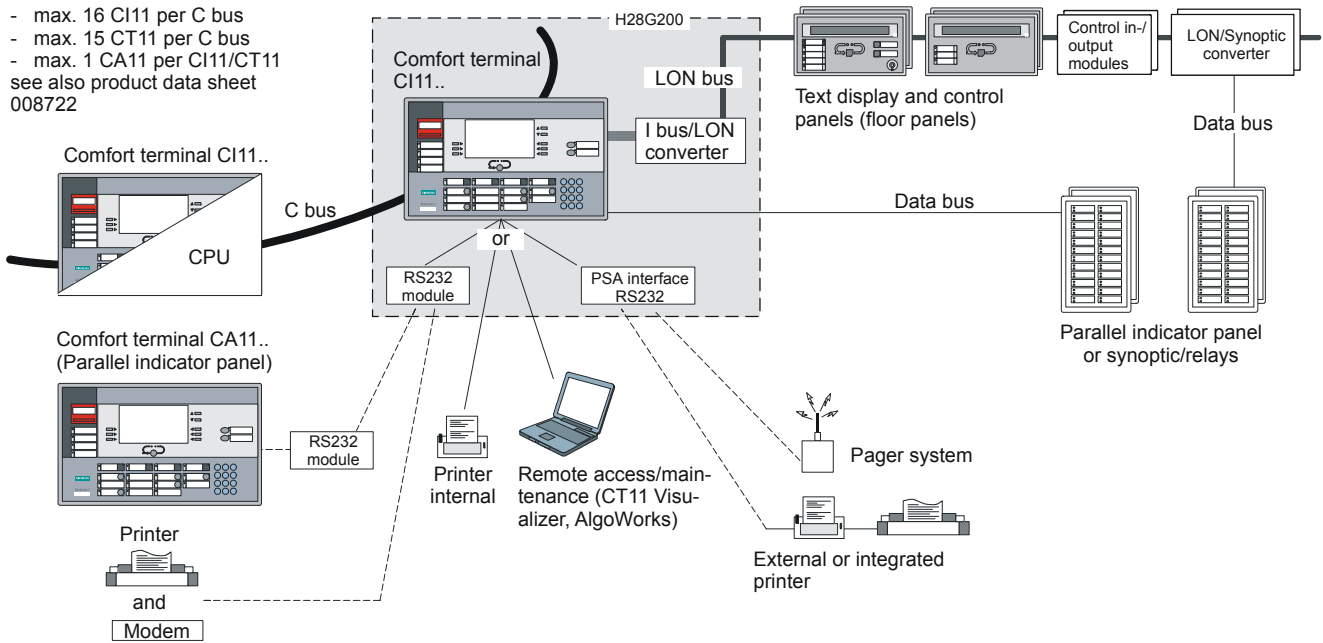

## Operation

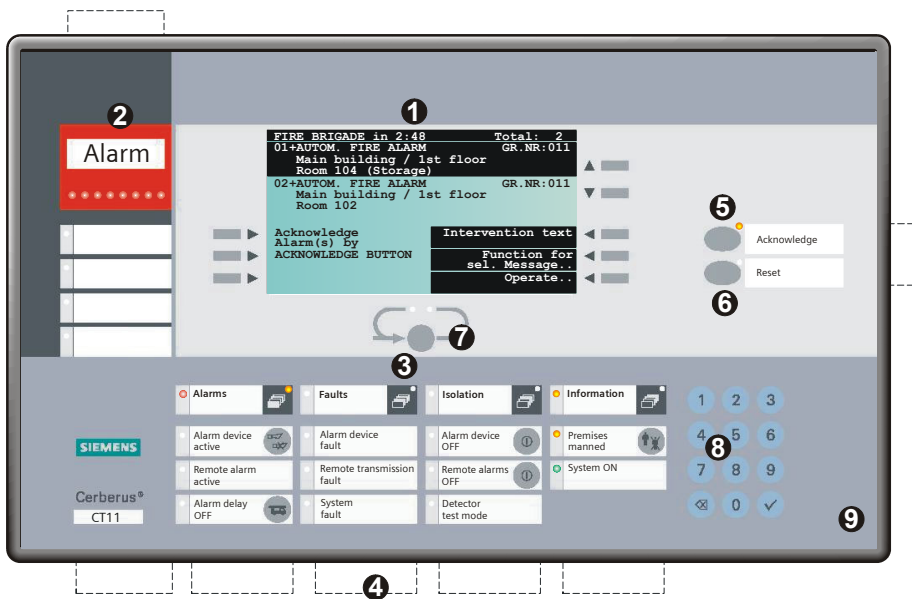

- 1 Large plain text display (LC Display, 240x128 pixels) with background illumination and detailed plain text information on all occurring events:
  - Event type, event location, measures texts, operating states etc.
  - Directly indicated operator guidance texts in alarm situations.
  - Context and system state dependent, comfortable operation with soft keys.
  - Access to other system functions via function menus definable via user profile.
- 2 Alarm indicator field: In case of alarm, the red writing "ALARM" lights up.
- 3 Indicator fields, partly with command keys
  - 4 ergonomically classified message categories: alarm, fault, isolation, information.
  - The main keys are equipped with light emitting diodes, for a concise, guided operation.
- 4 Insert able inscription strips in various languages.
- 5 Key "Acknowledge message"
- 6 Key "Reset message"
- 7 Key for switching forward alarm messages
- 8 Function key pad for numeric inputs (password, direct selection of locations etc.)
- 9 Optional key switch to enable operation. B3Q685 'CH' with Kaba key.

## Mounting possibilities

### Mounting in plastic housing H26G220

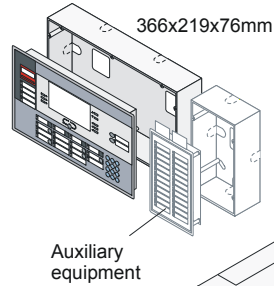

Auxiliary  
equipment

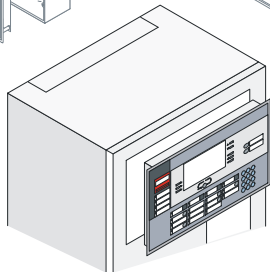

### Mounting in metal housing H28G200 with door H28T110

Cover plate or  
aux. equipment

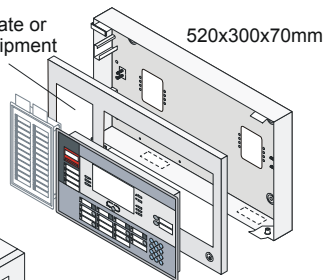

Mounting directly  
in control unit  
housing H47/67

### Mounting in metal housing H37G410 or H37G420

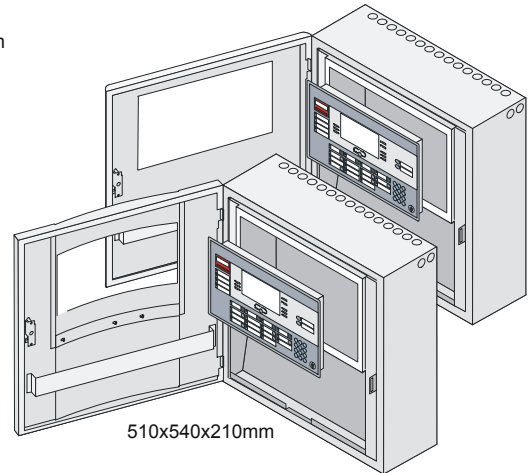

510x540x210mm

## Accessories

### Plexiglas door

Specially exposed operating terminals may be equipped with a lockable Plexiglas door to protect them from unauthorized access.

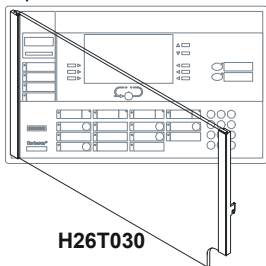

H26T030

### Key switch module (Kaba 8 #100)

For the locking of doors and/or access authorization for operation.

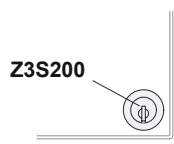

Z3S200

### Inscription set

The inscription of indication and operating elements is ensured by means of separate, insertable inscription strips.

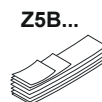

Z5B...

## Technical data

Operating voltage	18 ... 45 VDC
Current consumption at 24 V	
– Quiescent current (without LCD backlight)	100 mA
– Max. (with LCD backlight and lamp test)	420 mA
Operating temperature	0... + 50 °C
Storage temperature	–20... + 60 °C
Humidity (no condensation)	
– at T = 25 ±3 °C	≥95 % rel.
– at T = 40 ±2 °C	93 % rel.
Protection category (IEC 60529)	
– in plastic housing H26G220, control unit housings H38G220/320	IP 40
– in housings H28G200, H37G410/420, H47/67G611	IP 30
Color	
– H26G220	Pantone 421 grey
– H28G200, H37G410/420, H38G220/320, H47/67G611	RAL 7035 light grey
Approvals	VdS, LPCB, others

## Details for ordering

	Type	Item No.	Description	Weight
Operating terminal	B3Q660	5656000001	Comfort operating terminal 'International' without key switch	1.993 kg
	B3Q680	5698550001	Comfort operating terminal 'Nordic' with Nordic key switch	2.029 kg
	B3Q685	A5Q00003873	Comfort operating terminal 'CH' with Kaba key switch	2.133 kg
Plastic housing	H26G220	4628000001	Plastic housing for control terminals	0.435 kg
	H23G230	4750910001	Plastic housing for auxiliary equipments	0.197 kg
Metal housing	H28G200	4099440001	Housing base	2.583 kg
	H28T110	4749820001	Cover for housing base H298G200	1.141 kg
	H37G410	5339590001	Housing with flat door	18.550 kg
Accessories	H37G420	5341070001	Housing with designer door	18.100 kg
	H26T030	5705300001	Plexiglas door for control terminal	0.350 kg
	Z3S200	5703490001	Key switch module 'Kaba'	0.110 kg
	Z5B415	5706530001	Inscription set 'Portuguese'	0.008 kg
	Z5B435	5706660001	Inscription set 'Dutch'	
	Z5B505	5706790001	Inscription set 'Turkish'	
	Z5B525	5706820001	Inscription set 'German CH'	
	Z5B535	5706950001	Inscription set 'German D'	
	Z5B545	A5Q00004396	Inscription set 'Italian CH'	
	Z5B555	5707050001	Inscription set 'Italian I'	
	Z5B565	5707180001	Inscription set 'French CH'	
	Z5B585	5707210001	Inscription set 'French F'	
	Z5B595	5707340001	Inscription set 'Danish'	
	Z5B605	5707470001	Inscription set 'Finnish'	
	Z5B615	5707500001	Inscription set 'Norwegian'	
	Z5B625	5707630001	Inscription set 'Swedish'	
	Z5B635	5707760001	Inscription set 'English'	
	Z5B645	5707890001	Inscription set 'English GB'	
	Z5B665	5707920001	Inscription set 'Spanish'	
	Z5B685	5706400001	Inscription set 'Hebrew'	