

# **SIEMENS**

## **General fire detection system planning**

### **Planning guidelines**

Data and design subject to change without notice. / Supply subject to availability.

© Copyright by  
Siemens Building Technologies AG

Wir behalten uns alle Rechte an diesem Dokument und an dem in ihm dargestellten Gegenstand vor. Der Empfänger anerkennt diese Rechte und wird dieses Dokument nicht ohne unsere vorgängige schriftliche Ermächtigung ganz oder teilweise Dritten zugänglich machen oder ausserhalb des Zweckes verwenden, zu dem es ihm übergeben worden ist.

We reserve all rights in this document and in the subject thereof. By acceptance of the document the recipient acknowledges these rights and undertakes not to publish the document nor the subject thereof in full or in part, nor to make them available to any third party without our prior express written authorization, nor to use it for any purpose other than for which it was delivered to him.

Nous nous réservons tous les droits sur ce document, ainsi que sur l'objet y figurant. La partie recevant ce document reconnaît ces droits et elle s'engage à ne pas le rendre accessible à des tiers, même partiellement, sans notre autorisation écrite préalable et à ne pas l'employer à des fins autres que celles pour lesquelles il lui a été remis.

Ci riserviamo ogni diritto relativo al presente documento e sull'oggetto illustrato in esso. La parte che riceve il documento si impegna a non renderlo accessibile a terzi, né per intero né in parte, senza la nostra previa autorizzazione scritta ed a non usarlo per altri scopi di quello per il quale è stato rilasciato.

<b>Foreword</b> .....	<b>1</b>
<b>1 Compliance with local national guidelines and regulations</b> .....	<b>1</b>
<b>2 Extent of monitoring</b> .....	<b>2</b>
<b>3 Zones with fixed extinguishing systems</b> .....	<b>4</b>
<b>4 Choice of detector</b> .....	<b>5</b>
4.1 General .....	5
4.2 Smoke detectors .....	9
4.3 Heat detectors types D/T .....	16
4.4 IR flame detectors type S.. .....	18
4.5 Manual call points .....	20
<b>5 Number and arrangement of point-type detectors</b> .....	<b>21</b>
5.1 General .....	21
5.2 Smoke detectors .....	24
5.3 Smoke detectors on flat ceilings .....	43
5.4 Smoke detectors on sloping ceilings .....	55
5.5 Heat detectors .....	68
5.6 Flame detector S2406 .....	77
5.7 Linear smoke detector DLO1191 .....	77
5.8 Air sampling smoke detection .....	77
5.9 Manual call points .....	78
<b>6 Detector zones and detection lines</b> .....	<b>80</b>
6.1 Terminology .....	80
6.2 Formation of detector zones .....	80
6.3 Maximum number of detectors per detector zone and detection line .....	83
6.4 Temporary, local switching off of fire detectors .....	84
<b>7 Fire detection system control unit</b> .....	<b>85</b>
7.1 Location of control unit .....	85
7.2 Remote display and operating terminal .....	85
7.3 Centralized or decentralized arrangement of the control unit in large fire detection systems .....	86
7.4 Configuration of the Cerberus fire detection system control unit .....	86
<b>8 Alarm</b> .....	<b>87</b>
8.1 General .....	87
<b>9 Fire control installations</b> .....	<b>88</b>
9.1 General .....	88
<b>10 Avoiding deceptive alarms</b> .....	<b>90</b>
10.1 General .....	90
10.2 Possible measures .....	90
<b>11 Procedure for planning a fire detection system</b> .....	<b>92</b>
<b>Keyword index</b> .....	<b>93</b>



# Foreword

These planning guidelines contain the basic know-how for the planning of sophisticated fire detection systems. It is an important tool and reference work for the planner of fire detection systems.

It contains basic information which applies to all fire detectors. As far as possible we have tried to provide a layout which can be used irrespective of detector type. Specific detector data is provided where it is needed in depth.

For the new **AlgoRex**<sup>®</sup> generation of detectors, such specific data are provided in separate documents as setting parameters differs considerably from the setting of previous generations of detectors.

However, section 5, «Number and arrangement of point-type detectors» also applies for **AlgoRex** detectors.

## 1 Compliance with local national guidelines and regulations

- The relevant local national planning and installation guidelines or regulations must be obtained and taken into account before starting with the planning of each project.
- Local national specifications:  
Such specifications always take priority. They are issued by insurers, authorities, PTT, associations, customers etc. They also include regulations in relation to approvals which must be complied with for the choice of equipment and systems.
- Requirements for specific products:  
These are taken from technical descriptions, service manuals etc. Technical data contained in such documents must be complied with.
- No requirements:  
Where no regulations must be taken into account, planning and installation must be carried out according to Cerberus planning guidelines which correspond to the level of performance of Cerberus products.

## 2 Extent of monitoring

In principle we should endeavour to provide complete monitoring in all fire compartments. The monitoring of selected fire compartments (partial monitoring) or selected rooms or groups of rooms (selective monitoring) should only be applied exceptionally.

With complete monitoring (or within partial monitoring) the following zones must also be monitored:

- Lift, transport, transmission and light shafts in which the nature of the structure or an accumulation of material poses a fire risk
- Cable ducts and shafts if they are accessible, or in close proximity to other sectors which are not isolated by fire-resistant divisions <sup>1)</sup>
- Sanitary and heating installation supply shafts if accessible, or in close proximity to other sectors which are not isolated by fire-resistant divisions <sup>1)</sup>
- Rooms for ventilation and air conditioning installations as well as fresh and used air ducts
- Ducts for chutes for material and refuse and their hoppers
- Closets and structures which are large enough for a person to enter
- Covered-in loading ramps with protruding roof if they are not at least isolated from the monitored sector by a fire-resistant <sup>1)</sup> division
- Storage areas under protruding roofs if they are not at least isolated from the monitored sector by a fire-resistant <sup>1)</sup> division
- Areas below galleries
- Voids in dropped ceilings and raised floors according to table Fig. 1
- Voids above dropped ceilings with evenly distributed openings of 50% of the surface area should be regarded as a part of the room just below
- Zones in rooms which are created by shelves or other fixtures and fittings which reach to within 30cm of the ceiling

### Exceptions to the rules concerning monitoring

- Sanitary installation rooms, e.g. washrooms, toilets, providing no combustible stocks or refuse are stored there, or the enclosing walls are non-combustible
- Cable shafts with cable sealing on each floor and which have no electrical switchgear or safety cut-out installations.
- Rooms which are protected by an automatic fire extinguishing system and are at least fire-resistant isolated should the automatic monitoring of these rooms provide no special advantages
- Voids in dropped ceilings and raised floors which according to table Fig. 1 are constructed as zones without monitoring

According to the situation, (to be determined in each case) the following can be excluded:

- Separate, fire-resistant <sup>2)</sup> isolated storage tank rooms
- Air raid shelters which in peacetime are not used for other purposes
- Residential zones, fire-resistant <sup>2)</sup> isolated
- Cold storage rooms and intense cooling plants  $\leq 50\text{m}^2$
- Separate battery rooms, fire-retardant isolated <sup>1)</sup>

<sup>1)</sup> Structural divisions are described as fire-retardant if they can withstand a fire for at least 30 minutes.

<sup>2)</sup> Structural divisions are described as fire-resistant if they can withstand a fire for at least 90 minutes.

Void features	Means of monitoring in this sub-section
Inaccessible or accessible and without fire load or sources of ignition or few and fire-proof electrical installations (at least self-extinguishing)	none
Accessible with electrical installations with cable trays concentrated at certain places or built-in electrical equipment (e.g. servo motors)	Selective monitoring along electrical installations or specific monitoring of the built-in electrical equipment
Accessible and large number of electrical installations distributed throughout	Room monitoring (complete monitoring of void)
Other/additional void features, which influence fire danger	Assess each situation according to the fire risk (likelihood of fire outbreak/consequences)

Fig. 1 Table Means of monitoring voids

# 3 Zones with fixed extinguishing systems

Fixed extinguishing systems should be installed in zones:

- Where rapid fire development and spread is highly likely (solvents stores, plastics stores etc.)
- Where the building construction has inadequate fire resistance (e.g. danger of collapse due to unprotected steel construction)
- With a high concentration of valuable property, or in which heavy damage can be expected calling for additional fire risk reduction (EDP systems, switchgear etc.)

The additional installation of a fire detection system in such zones is called for:

- To fulfil the protection target specified for this sector
- According to the actuation type of the extinguishing system

Depending on the fire development, there can be a considerable difference in time between the response of the fire detection system and the sprinkler system. In order to reduce the fire risk and fire damage it is often sensible to employ both in such sectors.



# 4 Choice of detector

## 4.1 General

- The specifying of which detector to use and where depends on
- the monitoring category or the general monitoring aim of the FDS\*
  - room height
  - the ambient influences including deceptive phenomena

### 4.1.1 Monitoring categories / monitoring aims of the FDS

The monitoring categories cover three different general monitoring aims of the \* fire detection system. They are adjusted to the fire risk and other application criteria.







Monitoring category	General monitoring aim of the fire detection system *	Fire risk / consequences	Application criteria	Application examples
	open incipient fire signalling required	low to medium	<ul style="list-style-type: none"> <li>- no danger to life and</li> <li>- unit structure or fire compartment <math>\leq 150\text{m}^2</math> and</li> <li>- little fire spread and/or</li> <li>- danger of smoke logging and</li> <li>- low concentration of valuable property</li> </ul>	<ul style="list-style-type: none"> <li>- Kitchens</li> <li>- Heating plants</li> <li>- Recreation rooms/lounges</li> <li>- Small garages</li> <li>- Small workshops</li> <li>- possibly small offices</li> </ul>
	smouldering incipient fire signalling not required			
	open incipient fire signalling required	medium to large	<ul style="list-style-type: none"> <li>- with danger to life or</li> <li>- no unit structure or fire compartment <math>&gt; 150\text{m}^2</math> or</li> <li>- with fire spread and/or</li> <li>- danger of smoke logging or</li> <li>- with medium concentration of valuable property</li> </ul>	<ul style="list-style-type: none"> <li>- Hotel rooms</li> <li>- Factory rooms</li> <li>- Offices with important documents</li> <li>- Research laboratories</li> <li>- Staircases</li> </ul>
	smouldering incipient fire signalling desirable			
	open incipient fire signalling required	large to very large	<ul style="list-style-type: none"> <li>- with high danger to life and</li> <li>- high risk of fire spread and/or</li> <li>- danger of smoke logging or</li> <li>- high concentration of valuable property</li> <li>- irreplaceable works of art</li> </ul>	<ul style="list-style-type: none"> <li>- Wards</li> <li>- EDP systems</li> <li>- Museums</li> <li>- Historical buildings</li> </ul>
	smouldering incipient fire signalling required			

Fig. 2 Table Monitoring categories, monitoring aims, fire risk, application criteria and application examples

## 4.1.2 Influence of room height

The higher the room, the weaker the influence of the fire phenomena to be detected. With increasing room height, in view of the greater room volume, an incipient fire can be larger without increasing the danger of rapid fire spread or a flashover.

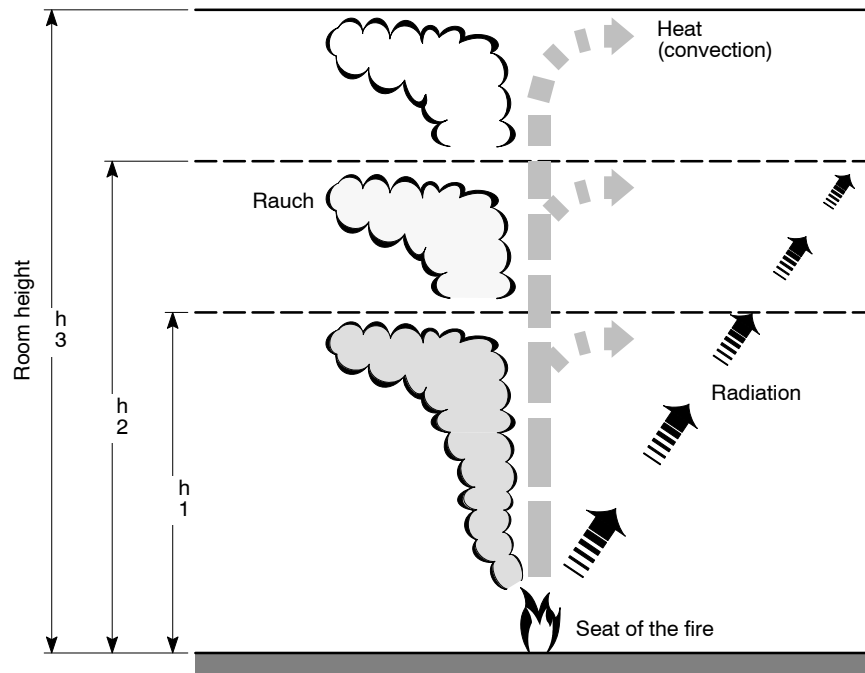

Fig. 3 Reduced influence of fire phenomena with increasing room height  $h$

### Smoke detectors

The thermodynamics of open fire transport smoke particles, which become diluted in the larger volume of air, even to very high ceilings.

Allowance for this smoke dilution can be made by employing sensitive smoke detectors.

Smouldering fires lack the thermodynamics to transport the smoke. Such fires are only detected by detectors on high ceilings when they develop into open fires.

### Heat detectors

The hot air currents rising from an open fire cool rapidly with increasing distance from the fire and increasing room volume. For this reason their limitations in respect of high-ceiling applications are soon reached.

### Flame detectors

Although heat radiation decreases by the square of the distance from the fire location to the detector, thanks to its high response sensitivity these detectors can also be used in high rooms.

## 4.1.3 Suitability table

The table shows an evaluation of the detectors according to their suitability in respect of the monitoring target (U) and room height (H). The overall suitability is found by multiplying the values U and H.











Monitoring category	Monitoring target of the DFS Detection of:	Suitability rating U = Suitability on the basis of monitoring target or monitoring category H = Suitability on the basis of room height h U x H = Detector suitability <b>Rating:</b> U x H = 4 very good suitable 2 well suited 1 suitable 0 in certain cases /must be checked - unsuitable	Suitability value of types of detector									
			Smoke detectors					Heat detectors			Flame detectors	
			F-detectors Sensitivity		R-detectors Sensitivity		Linear smoke detectors Sensitivity	Rate-of-rise detectors Sensitivity		Fixed temperature detectors	Infrared flame detectors Sensitivity	
Standard	selectable	Standard	selectable	selectable	cl.1	cl.2		selectable				
I	 open fire	U Suitability on basis of monitoring target	1	1	1	1	1	2	2	1	2	
II	 open fire  smouldering fire (desired)	U Suitability on basis of monitoring target	2	2	1	1	2	0**	0**	0**	0** (1 in combination with smoke detectors)	
III	 open fire  smouldering fire	U Suitability on basis of monitoring target	1	2	1	2	2	-	-	-	- (2 in (1 in combination with smoke detectors)	
			<b>H - values</b>									
		Suitability value H for room height h or mounting height of flame detector	Room height ≤4,5m	2	2	2	2	2	2	2	1	2
			>4,5 - <6m	2	2	2	2	2	2	1	0	2
			>6m - <7,5m	2	2	1	2	2	1	0	-	2
			>7,5m - <9m	1	2	1	1	2	0	-	-	2
			>9m - <12m	1	2	0	1	2	-	-	-	2
			>12m - <16m	0	2	-	0	1	-	-	-	2
			>16m - ≤20m	-	1	-	-	1	-	-	-	2
			>20m	-	0	-	-	0	-	-	-	1

Fig. 4 Suitability table for automatic fire detectors

\*\* see also section 4.1.5

#### 4.1.4 Combining different detectors

Fire phenomena vary in their physical characteristics according to the combustibles involved and fire development so that frequently fire detectors with different operating principles have to be used.

Monitoring category	Additional requirements	Variants	Recommended detector combination					
			F	R	D/T	S	A2400	
I 	If smoke detectors: Detection of smokeless fires	1	●		●			
		2	○			○		
		3		●	●			
		4		○		○		
		5				○	○	
		6				○	○	
II  	Detection of smokeless and smoke-forming fires	1	●		●			
		2	○			○		
		3		●	●			
		4		○		○		
		5			○		○	
		6				○	○	
	Room height ≥10m	1	●			●		
		2				○	○	
III  	Detection of smokeless and smoke-forming fires	1	●		●			
		2	○			○		
		3		●	●			
		4		○		○		
		5			○	○		
		6				○	○	
	Predominantly electrical risks, i.e. light smoke is to be expected	1	●	●				
		2	○			○		
		3		○		○		
	Room height 6 - 10m	1	○			○		
	Room height >10m	1	●			●	●	
		2				○	○	

Legend: ● frequent combination  
 ○ possible combination  
 F ionization smoke detector  
 R scattered light smoke detector  
 D/T heat detector  
 S IR flame detector  
 A2400 linear smoke detector

Fig. 5 Table Summary of suitable combinations of types of detector

#### 4.1.5 Taking ambient conditions into consideration

A detector may not be exposed to impermissible ambient influences if it is to operate without giving false alarms:

- Ambient temperature above or below those specified for the detector	} particularly in the case of
- Excessive vibration caused by mounting the detector on machine equipment	
- Too high humidity	} all types of detector
- Corrosive environment	
- Smoke, dust, steam or other aerosols caused by work processes	} Smoke detectors
- Sources of heat, heat radiation and hot steam	
- Modulated heat radiation, sometimes also light reflection in the open air	} Heat detectors
	} Flame detectors

The permissible data can be found in the following tables with detector features.

If, due to impermissible deceptive phenomena, heat and flame detectors have to be installed in rooms with monitoring category II, often other fire protection measures of a preventive and/or defensive nature are called for (see Fire Protection Planning, CRP, document e431).

#### 4.1.6 Fire detection reliability

Generally speaking, only those detectors should be used which on the basis of their characteristic data or adjustability, guarantee false alarm-free operation. The temporary switching-off of automatic detectors for operational reasons should be avoided. A better solution is to use a less sensitive type of detector and keep it in operation.

#### 4.1.7 Special investigations

If the prevailing conditions are not covered by these guidelines, or not in sufficient detail, such as unforeseeable fire development, spread of fire phenomena, prevailing deceptive phenomena etc. special investigations should be carried out, e.g. fire tests. For this purpose, analogue signal measuring detectors of the same type with evaluating and display equipment are available.

### 4.2 Smoke detectors

#### Application:

- Where smoke is the fire phenomenon to be expected
- Where the smoke detectors are not excluded by the ambient conditions

#### Detection characteristics:

- F-Types:** Detect all kinds of smoke  
**R-Types:** Detect visible, particularly light smoke  
**Linear Types:** Detect visible smoke

**Note: The detection characteristics of the new AlgoRex generation of detectors with AlgoLogic, differentiate themselves in some ways considerably from the types of detector dealt with below. This mainly concerns the response behaviour of the F- and R-types as well as the recommendations on the suppression of false alarms. AlgoRex detectors are described in the DS11 manual.**

**Smoke detectors with adjustment facility:**

- Even in their least sensitive setting conform to standards
- Can be adapted to specific ambient conditions, e.g.:
  - In EDP rooms
  - In high rooms
  - By risk of false alarms

**Integrating smoke detectors:**

- Can be used to prevent false alarm through transient deceptive phenomena such as cigarette smoke, specially in rooms of <3m in height.

**Alternative:** The detector zone must be connected to an intermediate alarm memory.

## 4.2.1 Smoke detectors F-Type

**Application:** Smoke detector for universal application

Operating principle	Application	Deceptive phenomena	Type/model detector	Special features
F-Smoke detector	Detection of all incipient smoke-producing fires  Generally suitable for monitoring rooms  Highly suitable e.g. for: - Offices - Cleaning closets - Corridors - Staircases - Rest rooms/lounges - Residential premises - Hospital wards - Hotel rooms - Attics - Museums - Showrooms - Weaving mills - Spinning mills - Printing shops - Carpenter's shops - Storerooms - High rooms - air conditioning ducts (with air sampling unit) - Industrial buildings etc.  Also suitable for monitoring installations e.g.: - Monitoring of air currents up to 20m/s using air sampling unit - in air-sampling systems - in switching cabinets etc.	All floating particles if in concentrated form (smoke also consists of floating particles) e.g.: - Water vapour - Exhaust gas from combustion engines - Welding work, soldering - Plastic processing - Cooking over flame, grilling, baking - Cigarette smoke - Paraffin vapour - Whirling dust - Fog-forming chemicals	F716i	Standard, EN 54-7/9, no adjustment facilities, for MS7-, MS9 and MS9i-System
			F716Vi	As for F716i, but with <b>integration</b> to suppress the influence <b>transient</b> deceptive phenomena (cigarette smoke), e.g. general application in rooms less than 3m high
			F732	As for F716 but with one adjustment facility: - 3 sensitivity settings
			F906	Standard, EN 54-7/9, with one adjustment facility: - two-stage smoke entries to adapt to conditions at the place of installation
			F905	As for F906 but AFNOR standard (sampling chamber supervised) and fixed smoke entries, without integration
			F900	Standard, EN 54-7/9 with three adjustment facilities: - 3 sensitivity settings - 2 integration stages - two-stage smoke entries to adapt to conditions at place of installation
			F911	As for F910 but intrinsically safe for explosion hazard zones 1+2 acc. to EN 50 020
F915	As for F910 but AFNOR standard (sampling chamber supervised) no integration			
F930	Standard, EN 54-7/9 with three adjustment facilities: - 2 sensitivity settings - two-stage smoke entries to adapt to conditions at the place of installation further features: - Drift indication on inquiry (MS9-PLUS®) - Monitored sampling chamber with fault indication at inadmissible deviation			

## Detector setting in dependence of monitoring category, room criteria and room height

Application features		Sensitivity setting (1-3) / Smoke entry			
Monitoring category	Room criteria	Room height in metres			
		<3	3...6	6...12	12...20
I	normal, clean or slightly dirty rooms	1 ○	1 ○	1 ○	2 ○
II	normal, clean or slightly dirty rooms	1 ○	1 ○	1 ○	2 ○
III	normal, clean rooms	2 ○	2 ○	3 ○	3 ○
	slightly dirty rooms	1 ○	2 ○	3 ○	3 ○

Fig. 6 Table Application of adjustment facilities

- Smoke entry small
- Smoke entry large

For application in rooms with a room temperature of  $<0^{\circ}\text{C}$ , response sensitivity must be set to setting 1.

permissible ambient temperature in $^{\circ}\text{C}$	Humidity	max. application height above sea level (m)	IEC protection cat. (detector / base)	Degrees of resistance to			Influence of air currents	
				dry dust	Fibres (heavy fibre content)	Accumulation of moist, dirt, grease	transient max.	continuous max.
-10 °...+60°	$\leq 75^{\circ}\text{C}$	1'500	IP 43	very good	adequate	unsuitable	10m/s	5m/s ( $V > 6\text{m/s}$ sensitivity increase until false alarm)
-25 °...+80°	$\leq 75^{\circ}\text{C}$	1'500	IP 43	very good specially with small smoke entries	good	critical possibly, check using test	10m/s	5m/s ○ ( $V > 7\text{m/s}$ sensitivity increase until false alarm)
-25 °...+80°	$\leq 75^{\circ}\text{C}$	3'000 (set to sensitivity setting 3)	IP 43	very good specially with small smoke entries	good	critical possibly, check using test	10m/s	8m/s ○ ( $V > 10\text{m/s}$ sensitivity increase until false alarm)
-25 °...+80°	$\leq 75^{\circ}\text{C}$	3'000 (set to sensitivity setting 3)	IP 43	very good	good	adequate	10m/s	○ Smoke entry large

## 4.2.2 Smoke detector R-Type

### Application:

- Where pyrolytic smouldering fires are to be expected
- Is only limited suitable for dusty environments such as textile factories, carpenters' shops, mills etc. If too many dust particles or individual fibres enter the detector's highly sensitive optical system, this can lead to false alarm.
- As the scattered-light smoke detector can only detect an open cellulose fire at a late stage, they are frequently combined with F-smoke detectors in rooms where more than 1 detector is required at a ratio of 1:1.

Operating principle	Application	Deceptive phenomena	Type/model detector	Special features
R-Smoke detector	<p>Detection of fires with visible smoke</p> <p>Generally suitable for monitoring rooms where mainly pyrolysis smouldering fires are expected e.g. for:</p> <ul style="list-style-type: none"> <li>- Electrical installations of all kinds *</li> <li>- Bed rooms</li> <li>- Hotel rooms</li> <li>- Car parking garages</li> <li>- Restaurants</li> <li>- Rooms with high rate of air exchange</li> </ul> <p>Also suitable for monitoring installations e.g.:</p> <ul style="list-style-type: none"> <li>- Switching cabinets</li> <li>- Air sampling systems</li> </ul> <p>* Mixed monitoring with F-types in a ratio of 1 : 1 recommended</p>	<p>All visible floating particles (larger 0,4µm) e.g.:</p> <ul style="list-style-type: none"> <li>- Water vapour</li> <li>- Visible exhaust fumes from diesel engines starting cold</li> <li>- Welding work</li> <li>- Plastic processing</li> <li>- Whirling dust</li> <li>- Fog-forming chemicals</li> <li>- Cigarette smoke</li> <li>- Textile fibres</li> </ul>	R716i	Standard, EN 54-7/9 and AFNOR standard (sampling chamber supervised), no adjustment facilities, for MS7-, MS9 and MS9i-System
			R910	Standard, EN 54-7/9, with three adjustment facilities: <ul style="list-style-type: none"> <li>- 2 sensitivity settings</li> <li>- 2 integrating stages</li> <li>- two-stage smoke entries to adapt to conditions at the place of installation</li> </ul> further features: <ul style="list-style-type: none"> <li>- long-term compensation of the alarm threshold value</li> </ul>
			R925	Standard, EN 54-7/9 and AFNOR standard (sampling chamber supervised), with one adjustment facility: <ul style="list-style-type: none"> <li>- two-stage smoke entries to adapt to conditions at the place of installation</li> </ul>
			R930	Standard, EN 54-7/9, with two adjustment facilities: <ul style="list-style-type: none"> <li>- 2 sensitivity settings to adapt to conditions at the place of installation</li> <li>- 2 integrating stages</li> </ul> further features: <ul style="list-style-type: none"> <li>- Guidance of smoke sensitivity</li> <li>- Drift indication on inquiry (MS9-PLUS®)</li> <li>- Fault indication at reaching the final value of the sensitivity guidance</li> <li>- Approval only with type of base Z94..</li> </ul>
R936	Like R930, but for the collective detection system MS9 <ul style="list-style-type: none"> <li>- Approval only with type of base Z94..</li> </ul>			



## Detector setting in dependence of monitoring category, room criteria and room height

Application features		Sensitivity setting (1-3) / Smoke entry			
Monitoring category	Room criteria	Room height in metres			
		<3	3..6	6..12	12..20
I	normal, clean or slightly dirty rooms	1 ○	1 ○	1 ○	2 ○
II	normal, clean or slightly dirty rooms	1 ○	1 ○	1 ○	2 ○
III	normal, clean rooms	2 ○	2 ○	3 ○	3 ○
	slightly dirty rooms	1 ○	2 ○	3 ○	3 ○

Fig. 7 Table Application of adjustment facilities

- Smoke entry small
- Smoke entry large

For application in rooms with a room temperature of  $<0^{\circ}\text{C}$ , response sensitivity must be set to setting 1.

permissible ambient temperature in $^{\circ}\text{C}$	Humidity	max. application height above sea level (m)	IEC protection cat. (detector / base)	Degrees of resistance to			Influence of air currents	
				dry dust	Fibres (heavy fibre content)	Accumulation of moist, dirt, grease	transient max.	continuous max.
-10 ... +60 $^{\circ}$	$\leq 75^{\circ}\text{C}$	unlimited	IP 43	good to adequate	inadequate	unsuitable	no influence	
-25 ... +75 $^{\circ}$	$\leq 75^{\circ}\text{C}$	unlimited	IP 43	good (compensation circuit)	inadequate	critical * * poss. check using test	no influence	
-25 ... +75 $^{\circ}$	$\leq 75^{\circ}\text{C}$	unlimited	IP 43	good to adequate	inadequate	unsuitable	no influence	
-25 ... +75 $^{\circ}$	$\leq 75^{\circ}\text{C}$	unlimited	IP 43	very good	good	critical * * poss. check using test	no influence	

## 4.2.3 Linear smoke detector A2400

### Application:

- In particular it is used in large rooms in which smoke can be expected as fire phenomena and wherever it is not excluded by ambient conditions
- The linear smoke detector is often superior to point-type detectors, e.g. for smouldering fires in ventilated rooms

### Requirements:

- Uninterrupted line of sight between the transmitter and receiver from 10 to 100m (anything in the way causes a trouble signal)
- The two units must be firmly mounted so that the IR beam does not become misaligned with the receiver due to building movement (heat/cold) which would cause an alarm or trouble signal.

**Important: It is essential to provide good accessibility to the transmitter and receiver for setting the system optics!**

Operating principle	Application	Deceptive phenomena	Type/model detector	Special features
Extinction smoke detector	<p>Detection of fires with visible smoke</p> <p>Monitoring beam of at least 10m up to maximum 100m</p> <p>180° deflection of monitoring beam with reflector possible</p> <p>Suitable e.g. for the monitoring of:</p> <ul style="list-style-type: none"> <li>- High rooms in which smouldering fires can be expected (mount detectors low down)</li> <li>- Rooms with powerful air currents (e.g. EDP systems)</li> <li>- Museums with valuable ceilings where point-type detectors are not desired</li> <li>- Rooms with ceilings where point-type detectors are not easily or inaccessible</li> <li>- Rooms in which point-type detectors quickly become soiled e.g. weaving mills, spinning mills)</li> <li>- Large and long rooms such as:               <ul style="list-style-type: none"> <li>- Hotel atria</li> <li>- Warehouses</li> <li>- Factory buildings</li> <li>- Power supply ducts</li> <li>- Corridors etc.</li> </ul> </li> </ul>	<p>All visible floating particles if in concentrated form e.g.:</p> <ul style="list-style-type: none"> <li>- Water vapour</li> <li>- Exhaust fumes from diesel engines starting cold</li> <li>- Welding work</li> <li>- Plastic processing</li> <li>- Whirling dust</li> <li>- Fog in winter with open buildings</li> <li>- Fog-forming chemicals of all kinds</li> </ul> <p><b>Condensation</b></p> <p>If mounted on cool outside walls, where high humidity and rapid increase in temperature is to be expected, measures to heating must be used to prevent</p> <p>Due to the long monitoring distance, the <b>accumulation</b> of deceptive phenomena applies</p>	<p><b>A2400</b></p> <p><b>Transmitter A2400S</b></p> <p><b>Receiver A2400E</b></p>	<p>Three defined response sensitivity stages selectable:</p> <p>Stage 1 = Extinction 60% in relation to entire measured distance</p> <p>Stage 2 = Extinction 35%</p> <p>Stage 3 = Extinction 20%</p> <p>Signal compensation circuit to increase service life</p> <p>Interruption of monitoring beam causes trouble signal (no alarm)</p> <p>Wide response spectrum to the various types of smoke</p> <p><b>Not suitable</b> for wide spread fires from liquids. A violent concentration of smoke can block the alarm actuation (interrupted light beam). For these risks the combination with point-type detectors may be considered (mixed monitoring)</p> <p><b>May not be operated with pulse memories!</b></p>

permissible ambient temperature in °C	Humidity	max. application height above sea level (m)	IEC protection cat. (detector / base)	Degrees of resistance to			Influence of air currents	
				dry dust	Fibres (heavy fibre content)	Accumulation of moist, dirt, grease	transient max.	continuous max.
-10 °...+60°	≤75°C	unlimited	IP 52	very good	good periodic external cleaning	adequate	no influence	

## 4.3 Heat detectors types D/T

### Application:

- In an incipient fire with rapid increase in temperature
- Where due to the presence of smoke and vapour etc. smoke detectors cannot be used.

Operating principle	Application	Deceptive phenomena	Type/model detector	Special features
Heat detector	Detection of incipient fires with rapid increase in temperature and where smoke detectors cannot be used due to deceptive phenomena or smokeless fire, e.g. in: <ul style="list-style-type: none"> <li>- Solvent stores</li> <li>- Heating plant rooms</li> <li>- Kitchens (do not forget water vapour)</li> <li>- Workshops</li> <li>- Dusty rooms</li> <li>- Small offices with only slight fire danger provided fire compartment <math>\leq 150\text{m}^2</math></li> </ul>	Sources of heat e.g. <ul style="list-style-type: none"> <li>- Radiators</li> <li>- Baking ovens etc.</li> </ul> Direct solar radiation Water vapour Rapid temperature fluctuation e.g. large doors leading to warm adjacent rooms	<b>D716</b>	Standard, EN 54-5, category 2 high resistance to corrosion
			<b>D900</b>	Standard, EN 54-5, category 1 high resistance to corrosion
			<b>D901</b>	As for D900, but intrinsically safe for explosion hazard zones 1+2, EN 50 020
			<b>D915</b>	As for D900, but AFNOR standard
			<b>D920</b>	As for D900, but for higher ambient temperature (EN 54-8, temperature range 1)
<b>D921</b>	As for D920, but intrinsically safe for explosion hazard zones 1+2, EN 50 020			
<b>D2417</b>	Standard, EN 54-5, category 1 with integrated base (Scandinavia)			
Dual heat detector	Detection of incipient fires with rapid increase in temperature and rooms in which normal heat detectors cannot be used due to a chemically aggressive atmosphere, heavy dust formation, high humidity, moisture etc. e.g.: <ul style="list-style-type: none"> <li>- Road tunnels</li> <li>- Wood chips silos</li> <li>- etc.</li> </ul> Cases where a higher response sensitivity is required than laid down in EN54-5	Sources of heat e.g. <ul style="list-style-type: none"> <li>- Radiators</li> <li>- Baking ovens etc.</li> </ul> Direct solar radiation Water vapour Rapid temperature fluctuation e.g. large doors leading to warm adjacent rooms	<b>D2401</b>	The detector contains two measuring systems with different response sensitivity System 2 sensitive System 1 insensitive, EN 54-5 category 2 Special composite circuit to increase response sensitivity <b>between</b> adjacent detectors Special type of base (Z2401) required No connection for external response indicator
<b>D2401 Ex</b>	As for D2401, but intrinsically safe for explosion hazard zones 1+2, EN 50 020			
Maximum heat detector	Detection of incipient fires upon exceeding the specified maximum temperature Application under tough ambient conditions e.g. the monitoring of: <ul style="list-style-type: none"> <li>- Oil baths</li> <li>- Hardening shops</li> <li>- Ships' engine rooms</li> <li>- Cupellation chambers (with sensor protective coating e.g. Teflon)</li> <li>- Large kitchens (e.g. direct installation of the D2410 in large extractor hoods)</li> </ul>	Work processes which allow ambient temperatures to exceed the specified maximum value	<b>D2409</b>	Compact model with 21.5cm long perforated, rigid protective tube Not compatible with base Temperature range $+40^{\circ}\text{C} \dots +300^{\circ}\text{C}$ Complies with <b>no</b> EN standards
			<b>D2410</b>	As for D2409, but with sensor separate from housing (connected via capillary tube) Capillary tube 2m long (up to max. 5m) Details and other dimensions can be found in the data sheet
			<b>T2418</b>	Standard, EN 54-8, Temperature range 1 ( $+74^{\circ} \dots +90^{\circ}\text{C}$ ) with integrated base (Scandinavia)
<b>T2416</b>	Standard, EN 54-5, category 2 with integrated base (Scandinavia)			

Permissible ambient temperature in 5C	Humidity	IEC protection category (detector / base)	Degree of resistance to			Influence of air currents	
			Dry dust	Fibres (heavy fibre content)	Accumulation of moist, dirt, grease, etc.	transient max.	continuous max.
-10 °...+50°	≤75°C	with standard base IP 43 with ZS90 IP 53 (detector IP 65)	very good	very good	good, provided protected from direct dirt accumulation	critical with strong draughts, which can carry away the heat	
-25 °...+50°	≤75°C	with standard base IP 43 with ZS90 IP 53 (detector IP 65)	very good	very good	good, provided protected from direct dirt accumulation	critical with strong draughts, which can carry away the heat	
-25 °...+50°							
-40 °...+50°	≤75°C	IP 43	very good	very good			
-25 °...+50°	≤95°C	IP 65	very good	very good	good, provided protected from heavy dirt accumulation	critical with strong draughts, which can carry away the heat	
-25 °...+60°	95%	IP 65	very good	very good	good, provided protected from direct dirt accumulation	critical with strong draughts, which can carry away the heat	
-25 °...+270°	100% for sensor + capillary tube	IP 65	very good	very good	good, provided protected from heavy dirt accumulation	critical with strong draughts, which can carry away the heat	
-40 °...+50°	≤75°C	IP 43	very good	very good			

## 4.4 IR flame detectors type S..

### Application:

- Are suitable for applications in which an incipient fire involving carbonaceous material is expected to produce flames instantaneously and where smoke and heat detectors are unsuitable.

### Detectable flaming fires

These are all flaming fires involving carbonaceous materials, such as wood, plastic, alcohol, mineral oil products, natural gas, butane, propane etc.

Operating principle	Application	Deceptive phenomena	Type/model detector	Special features
IR flame detector	Rapid detection of flame-forming fires e.g. in <ul style="list-style-type: none"> <li>- high rooms</li> <li>- churches</li> <li>- hangars</li> <li>- covered storage tanks</li> <li>- etc.</li> </ul> <p>The detector can <b>not</b> detect through window glass!</p>	Direct sunlight (but not through pane of glass) Sunlight reflected at a short distance from puddles, venetian blinds etc. unless filtered out by an intervening pane of glass, or by eliminating this phenomena by masking the angle of vision Modulated radiators *, such as <ul style="list-style-type: none"> <li>- hot an moving machine parts</li> <li>- machine parts</li> <li>- motors etc.</li> <li>- welding work etc.</li> </ul>	<b>S610 (1-channel detector)</b>	Standard with 2 adjustment facilities <ul style="list-style-type: none"> <li>- 2 sensitivity stages</li> <li>- 2 integrating stages</li> </ul> <p>MS6 base required</p> <p>Only slight loss of sensitivity from obstruction by fire smoke</p> <p>* The likelihood of detectors being deceived increases:           <ul style="list-style-type: none"> <li>- with increasing area</li> <li>- with increasing temperature</li> <li>- the shorter the distance from detector to source of nuisance signal</li> </ul> </p>
IR flame detector	Rapid detection of flame-forming fires in rooms and in the open air e.g. <ul style="list-style-type: none"> <li>- hangars</li> <li>- oil-cooled reactor pumps</li> <li>- refineries</li> <li>- oil rigs</li> <li>- ships' engine rooms</li> <li>- open-air stores</li> <li>- etc.</li> </ul> <p>The detector can <b>not</b> detect through window glass!</p>	Extremely immune to deceptive phenomena due to the correlation of 2 sensors built into the detector. Thus highly insensitive to: <ul style="list-style-type: none"> <li>- artificial light</li> <li>- sunlight and all kinds of heat, ultra-violet, x-ray and gamma radiation</li> </ul> <p>Susceptible to welding work<sup>1)</sup>, especially oxy-acetylene cutting. With powerful sun rays, detector axis towards the sun, radiation modulated and made more sensitive by clouds in blue sky, detector adjustment cannot eliminate deceptive alarms. The same applies to modulated and very hot bodies which are only a few metres from the detector. By reducing detector sensitivity (1 or 2) the detector is once again immune to deceptive phenomena. Therefore, the detector must <b>not</b> be turned towards the sun.</p>	<b>S2406 (2-channel detector)</b>	Standard with 2 adjustment facilities <ul style="list-style-type: none"> <li>- 2 sensitivity stages</li> <li>- 2 integrating stages</li> </ul> <p>Special base (Z2406, IP 65) required</p> <p>Only slight loss of sensitivity from obstruction by fire smoke</p> <p>The detector must be able to see the flame. The rain hood must be used for applications in the open air</p>
			<b>S2406 Ex S2406 SEx</b>	As for S2406, but intrinsically safe for explosion hazard zones 1+2, EN 50 020 <sup>1)</sup> Electrical welding only at short distance to detector
			<b>S2406 R S2406 REx</b>	As for S2406, but with rapid alarm actuating (R=rapid) for special applications in rooms

**Non-detectable flaming fires**

These are flaming fires involving exclusively non-organic elements such as phosphorus, sodium, magnesium and hydrogen.

However, as other materials are usually present in almost every fire, e.g. packing material, even these «non-detectable» fires can be detected.

permissible ambient temperature in °C	Humidity	IEC protection category (detector / base)	Degree of resistance to		Influence of air currents	
			Dry dust, fibres	Accumulation of moist, dirt, grease, etc.	transient max.	continuous max.
-20 °...+70°	≤75°C	IP 43	good (nevertheless keep optics clean)	poor, optics become obscured	No influence	
-40 °...+70°	≤95°C	IP 65	good (nevertheless keep optics clean)	poor, optics become obscured	No influence	
	≤95°C					

## 4.5 Manual call points

### Application:

- For immediate manual actuation of fire alarm
- For immediate manual alerting of external fire-fighting forces

For safety, the alarm actuating element is protected by a glass plate which must be broken in order to give an alarm.

### 4.5.1 Special design manual call point

- For immediate manual actuation of fixed extinguishing systems such as gas and deluge systems.

Operating principle	Application	Danger of erroneous actuation
Breaking of the glass plate	<ul style="list-style-type: none"> <li>- along escape routes, e.g. exits, corridors, staircases</li> <li>- in specially hazardous areas, e.g. chemical laboratories, solvents stores</li> <li>- at extinguishing cabinets</li> <li>- in areas where automatic detectors frequently have to be switched off, or only insensitive detectors can be operated</li> <li>- in and at the entrance to extinguishing sectors</li> </ul>	<ul style="list-style-type: none"> <li>- When mounted close to light switches</li> <li>- When mounted at exposed parts of buildings e.g. risk of damage from vehicles</li> <li>- Penetration by water, e.g. from snow in multi-storey parking</li> <li>- Deliberate actuation when mounted in places where people act and escape unobserved e.g. in multi-storey parking, or where units are mounted on outside walls</li> <li>- Where the purpose of the unit is not clearly shown</li> </ul>

Type/model unit	Permissible ambient temperature in °C	Humidity	IEC protection category	Special features
AT50	-25 °...+80°	≤75°C	IP 30	Standard manual call point for surface mounting
AT51				As for AT50, but with protective cover
AT50Mi				Addressable standard manual call point for surface mounting
AT51Mi				As for AT50, but with protective cover
ATAN50	-25 °...+80°	≤100°C	IP 66	Model for wet and very dusty applications and in explosion hazard areas Application in intrinsically safe areas



# 5 Number and arrangement of point-type detectors

## 5.1 General

### 5.1.1 All detector types

The fire phenomena which are utilized for fire alarm (smoke, heat, radiation) spread in different ways. Therefore, the number of detectors required (or the monitoring area per detector) is to a large extent influenced by the spreading characteristics of the fire phenomena concerned.

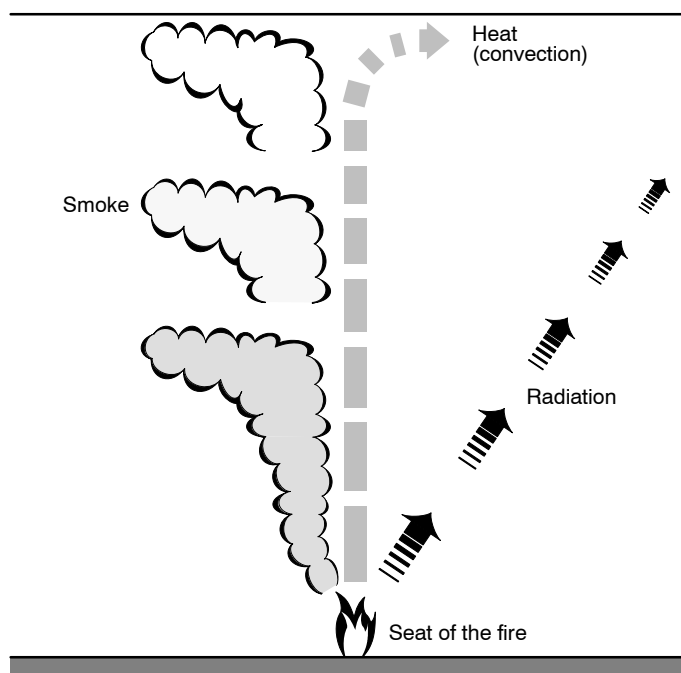

*Fig. 8* The different spreading characteristics of various fire phenomena

In general, a fire detection system with a decreasing monitoring area per detector becomes more sensitive because the distance between the detector and fire location is smaller. Beyond a certain size of monitoring area (particularly with smoke detectors) an increase in the number of detectors produces little gain in sensitivity. We must strive for a sensible ratio between cost and effectiveness when choosing a suitable monitoring area.

Thus the number and arrangement of automatic detectors depends on:

- the type of detector used and its sensitivity
- room geometry
- ambient conditions

They must be so chosen and arranged so that incipient fires can be detected at an early stage (see also the section on system test fires).

Each room to be monitored must contain at least one automatic detector. Smoke and heat detectors are mounted on the ceiling or wherever the fire phenomena to be expected spread and accumulate. As far as possible, flame detectors require direct line of sight to every likely fire location and, therefore, are best installed high up in the corners of a room.

The detector arrangement must be adapted to the prevailing features of the room such as ceiling construction, room division, (wall recesses etc.) furnishings, fittings etc. Other aspects to be taken into account:

- It must be possible for the corresponding fire phenomena (smoke/heat/ radiation) to reach the detectors
- Foreseeable deceptive phenomena
- Foreseeable mechanical influences (vibration etc.)
- Correct testing and exchanging

Often when positioning detectors it is necessary, for aesthetic or construction reasons, to make a compromise whereby the maximum prescribed distances or monitoring areas may be exceeded by up to 10%.

## 5.1.2 Cross-zoning

When detectors are cross-zoned the permissible monitoring area for the same type of detector must be reduced in principle by 50%, providing that the alarm signal is only actuated by two linked detector zones. Excluded from this exception is the cross-zoning of detectors for specific purposes to prevent false alarms, e.g. smoke detectors in parking garages. Here the detectors must be uniformly and symmetrically distributed through the two zones.

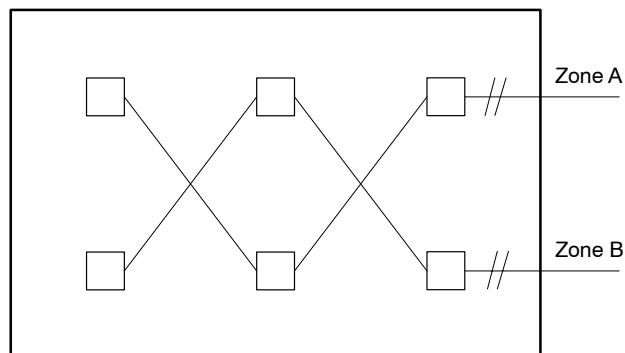

Fig. 9 Cross-zoned room monitoring with 2 detection lines (conventional solution)

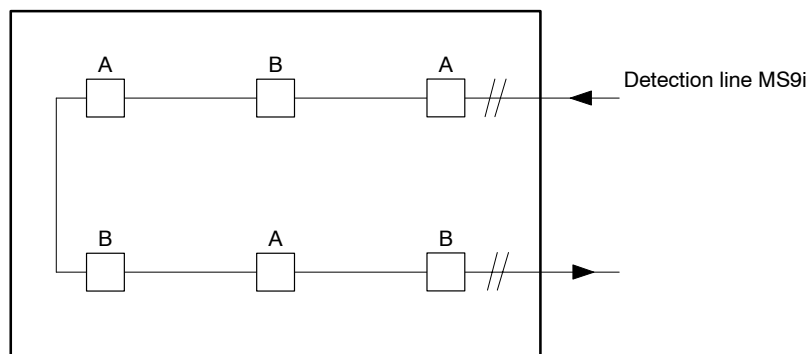

Fig. 10 Cross-zoned room monitoring with addressable detection system MS9i

### 5.1.3 Special cases

Special cases which are not covered by the Cerberus guidelines, or not in sufficient detail, and the causes of which lie in the fire hazard, the type of detector used, room geometry, room utilization, or the ambient conditions, require individual treatment. It may be necessary to determine the number of detectors and their locations by carrying out fire tests with measuring detectors and the corresponding measuring equipment.

### 5.1.4 Planning symbols for fire detection systems (ISO/DIS 6790.2)

Symbol	Designation	Symbol	Designation
	Fire detector		Transmission equipment (Model ...)
	Ionization smoke detector		Receiving equipment (Model ...)
	Scattered light smoke detector		Signal box (Model ...)
	Heat detector		Audible alarm device (Model ...)
	Maximum temperature detector		Visual signal transmitter (Model ...)
	Flame detector		Permanent magnet (Model ...)
	Linear smoke detector		External control relay fire control installation
	Air sampling unit ASD-Duct		Signal display panel of actuation of extinguishing (Model ...)
	ASD (ASD-Mono, ASD-Flex, ASD-Modular)		Extinguishing system valve
	Manual call point		Response indicator
	Automatic alarm transmitter for extinguishing system		
	Fire detection system control unit (Model ...)		
	Signalling, e.g. mimic panel, terminal etc. (Model ...)		
<b>Supplementary equipment for addressable detection system MS9i</b>			
	Ionization smoke detector in a Z90i base		Manual call point AT50Mi
	... detector in a Z90Mi base		Manual call point for parallel operation AT50Si
	... detector in a Z90Si base		Control element E90Ci
	Master element E90Mi		

## 5.2 Smoke detectors

### 5.2.1 Influence of room height

As the room height increases, so smoke density decreases because the quantity of smoke is distributed throughout a greater volume of air.

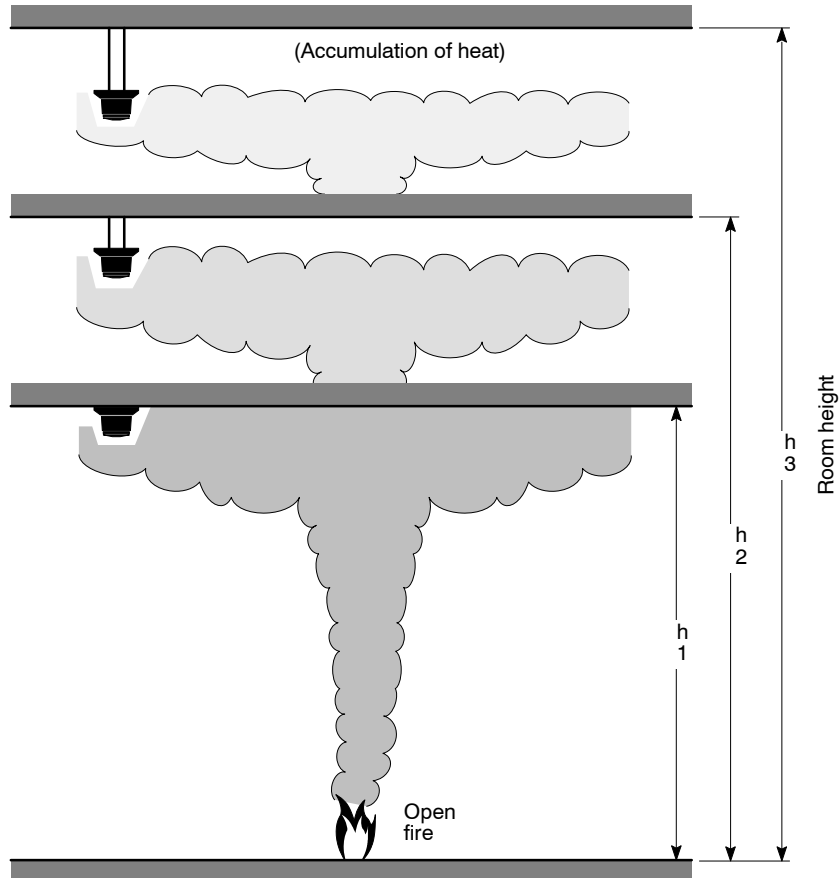

Fig. 11 Decrease in smoke density and smoke distribution with increasing room height

The higher the room, the further away from the ceiling the detector must be mounted. The smoke which gradually cools as it rises cannot break through the cushion of warm air.

The mounting of point-type smoke detectors on the wall is only effective if the room is of small dimensions.

Smouldering fires usually have insufficient thermal current to carry smoke to high ceilings.

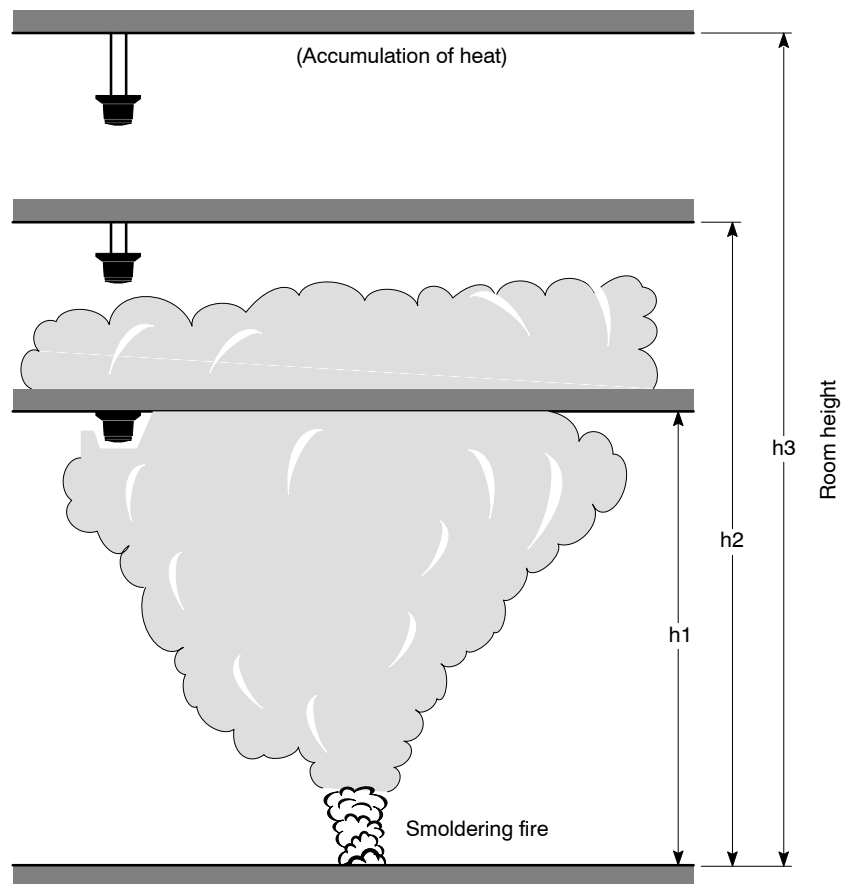

Fig. 12 Smoke distribution in a smoldering fire with little thermal current

### Consequences

With increasing room height:

- response sensitivity of the fire detection system decreases
- the incipient fire would have to be larger to actuate an alarm
- the smoke from a larger incipient fire would spread over a greater ceiling area
- the smoke from smoldering fires would not reach the ceiling

These physical conditions must be taken into account when installing the fire detection system as shown in Fig. 13 below.

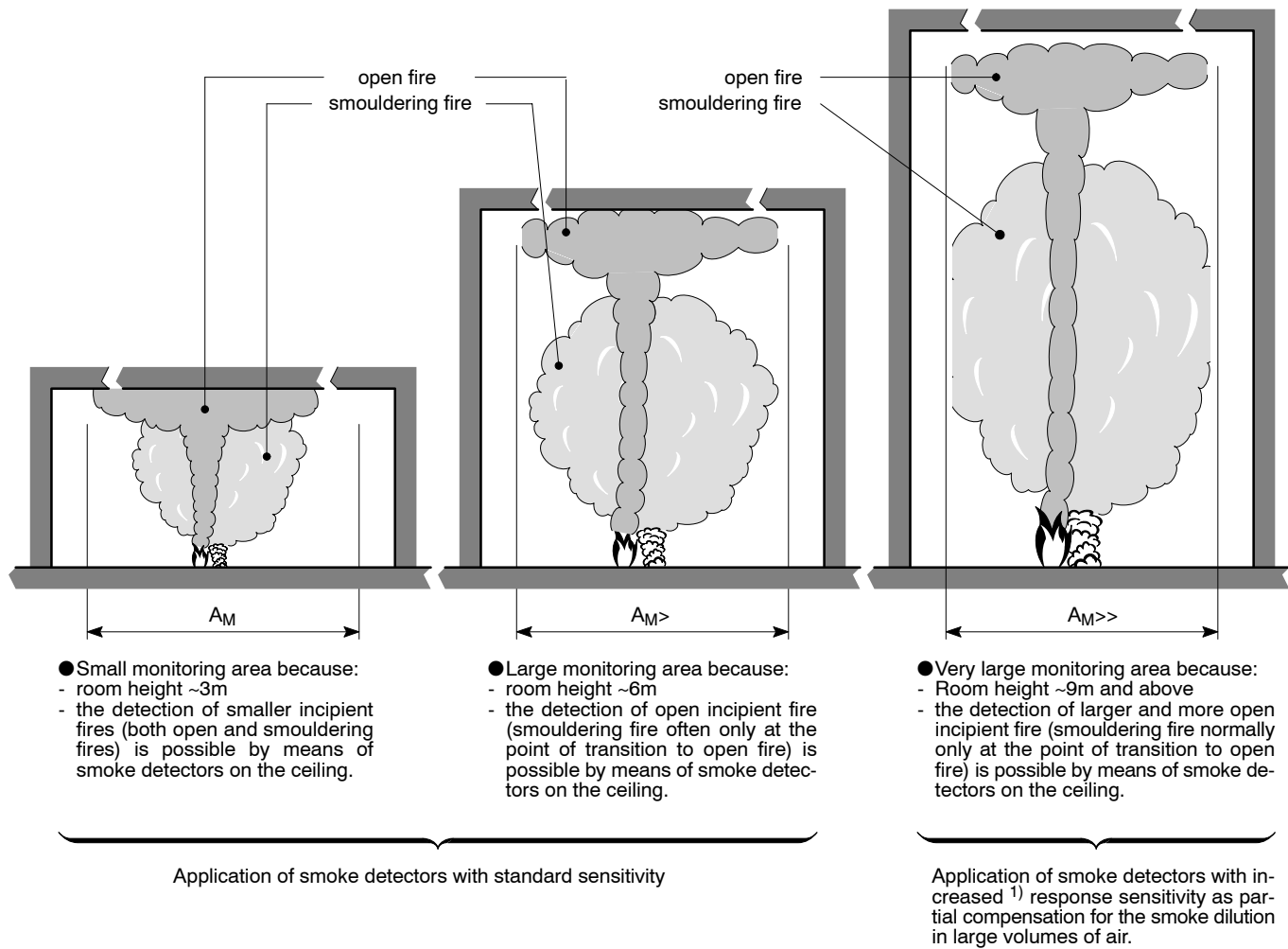
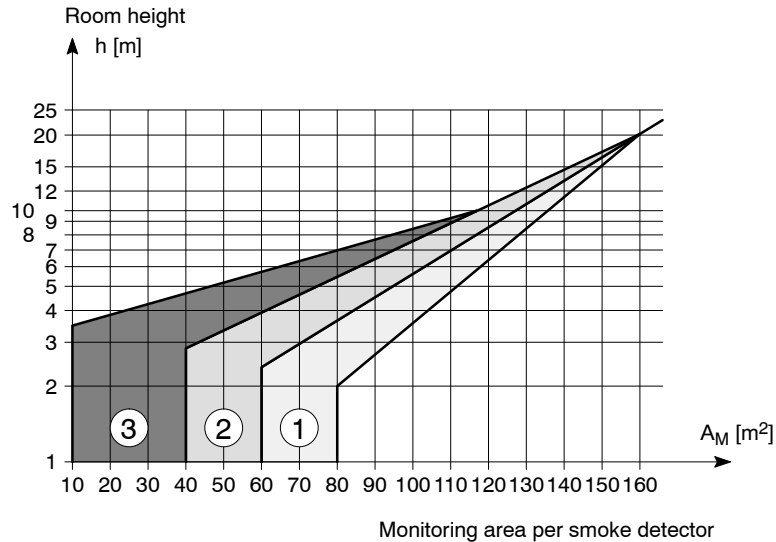

**Fig. 13** Taking increasing room height into consideration when planning a fire detection system

<sup>1)</sup> The immunity to deceptive phenomena of this smoke detector with increased sensitivity is normally maintained by increasing room height itself, as deceptive phenomena without any appreciable inherent thermal current cannot reach the ceiling.

## 5.2.2 Monitoring area per smoke detector

The monitoring area ( $A_M$ ) is determined as a function of room height and the fire danger.



**Degree of danger**  
 1 little fire danger  
 2 moderate fire danger  
 3 major fire danger

*Fig. 14* Monitoring area per smoke detector as a function of room height and degree of danger

Degree of danger 2 can be chosen for most applications

Degree of danger 1 should only be chosen:

- if all danger to life can be eliminated
- if no valuable or irreplaceable articles are stored in the room concerned
- if the fire risk is low
- if other fire protection measures would virtually preclude fire spread
- if no smoke logging, in particular involving corrosive fission products, can occur in adjacent areas

Degree of danger 3 is recommended if:

- if there is serious danger to life
- if valuable and/or irreplaceable articles are stored in the room concerned
- if the loss of goods or installations would threaten the existence of the owner of the premises concerned
- if the fire risk is classified as «high»

### 5.2.3 The influence of exchange of air

In artificially ventilated rooms the spread of smoke is disturbed. The greater the exchange of air the more the smoke particles are continuously carried away so that a uniform smoke concentration cannot be formed. As the amount of smoke is reduced and varies from place to place this leads to a reduction in sensitivity of the fire detection system. This can be partly compensated for by reducing the monitoring area and increasing detector sensitivity.

To reduce the monitoring area for a situation with increasing air change, the monitoring area based on the room height must be reduced by the following multiplication factors:

Air change per hour	Multiplication factor to reduce smoke detector $A_M$
>10 <20	0.9
>20 <30	0.8
>30 <40	0.7
>40 <50	0.6
>50 <75	0.5
>75 <100	0.4
>100	0.3
Example: Air change 25 times $A_M$ 100m <sup>2</sup> Result: 100m <sup>2</sup> x 0.8 = 80m <sup>2</sup> $A_{Mk}$	

*Fig. 15* Reduction of the monitoring area per detector in rooms with an abundant change of air

$A_M$  = Monitoring area  
 $A_{Mk}$  = Monitoring area rectified



## 5.2.4 Maximum detector spacing (s)

The maximum permissible distance from detector to detector or detector to wall depends on the chosen monitoring area  $A_M$ .

In principle a detector monitors a circular area. The maximum distance from detector to detector as defined by Cerberus is approximately the diameter of this circle. The square based on this diameter has a larger area than the selected monitoring area  $A_M$ . In order that  $A_M$  can be maintained, the maximum distance between detectors may only be applied in one direction (length or width) and must be reduced in the other direction.

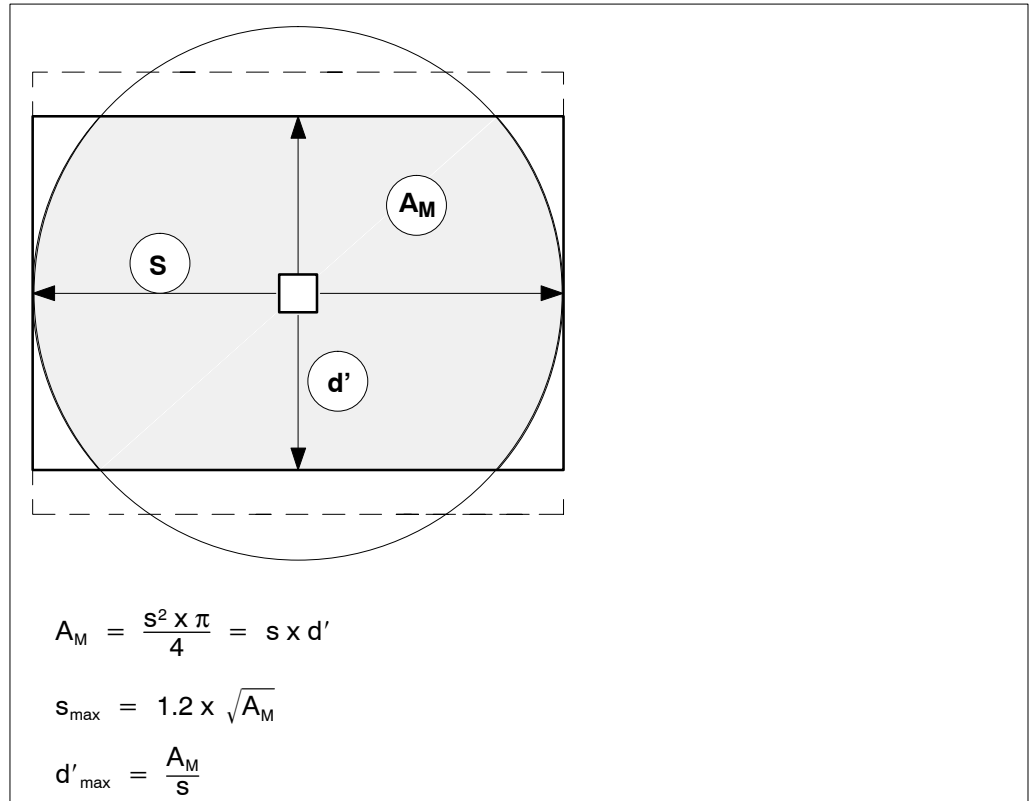

Fig. 16 The relationship between the monitoring area and the maximum distance between detectors (s)

Maximum distance detector  $\rightsquigarrow$  wall

$$\frac{1}{2} s = \frac{1.2 \sqrt{A_M}}{2}$$

For practical reasons the maximum distance detector  $\rightsquigarrow$  wall must be measured at right angles horizontally to the wall and not to the corner of the room (this is why the factor 1.27 is rounded down to 1.2).

Fig. 17 below shows the symmetrical distribution of detectors maintaining the permissible detector spacing and the monitoring area  $A_M$ .

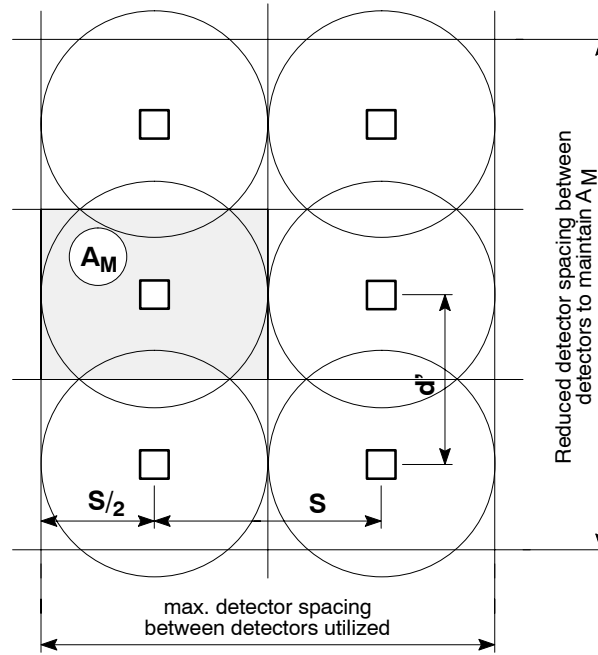

$$s = 1.2\sqrt{A_M}$$

Fig. 17 Distribution of detectors

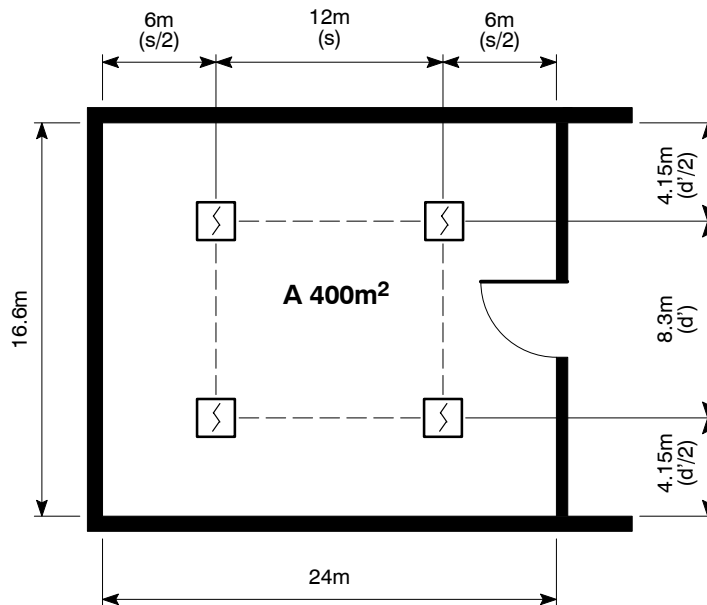

Fig. 18 Example  $A_M$  100m<sup>2</sup>

If for reasons of room geometry, or due to obstacles which prevent detector mounting (e.g. light fittings) maximum detector spacing is applied in both directions, the monitoring area  $A_M$  must still be maintained.

### 5.2.5 Minimum detector spacing

The distance from the detectors to the walls, fittings and stored goods may not be smaller than 0.5m except in corridors, ducts and other similar parts of a building with a width of less than 1m. If there are joists or beams, or, e.g. air conditioning ducts under the ceiling which are closer to the ceiling than 0.15m, then the lateral distance must be at least 0.5m.

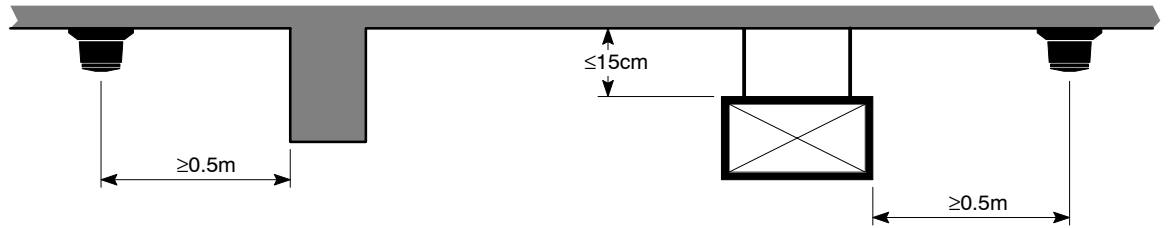

Fig. 19 Distances between detectors and walls, joists and fittings

### 5.2.6 Racks, stored goods

Stored goods or racks whose distance from the ceiling is less than 0.30m, prevent smoke spread to such an extent that they must be treated as room dividers (walls).

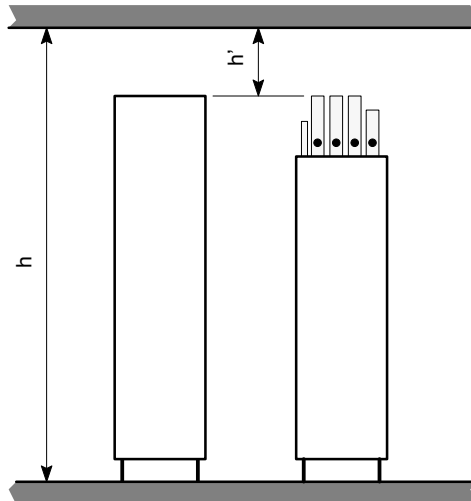

Fig. 20 Room divide =  $h' < 0.3\text{m}$

## 5.2.7 Roof structures

Roof structures which are connected to the room to be monitored and whose surface area exceeds 10% of the total ceiling area, or providing this portion of the ceiling is  $>A_M$ , must be regarded as separate rooms. Otherwise they need not be taken into account.

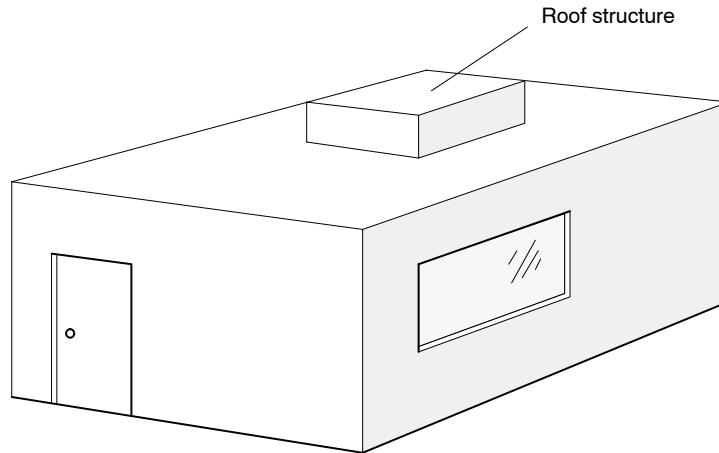

Fig. 21 Room with roof structure

### Wall-mounting of smoke detectors

For installation reasons the mounting of detectors on the wall can be useful in small rooms, providing that 1 detector is enough for monitoring and the following conditions can be maintained.

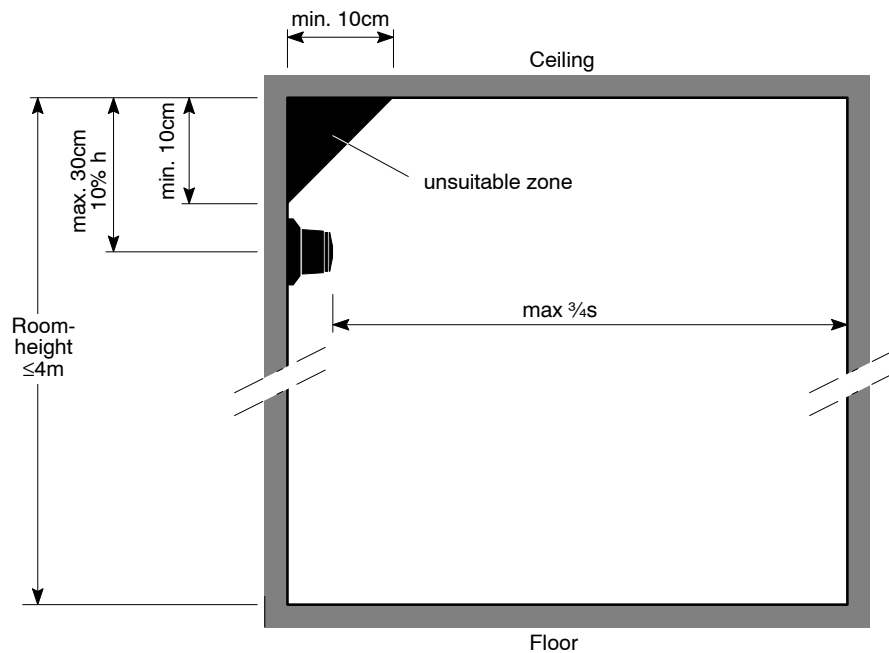

Fig. 22 The wall-mounting of smoke detectors

## 5.2.8 Ceiling vents

With ceiling vents (Cupolux, domed vents, dampers etc) detectors must be mounted in the vicinity of the vents providing the distribution of the vents, the monitoring area and the maximum distance between detectors permit this.

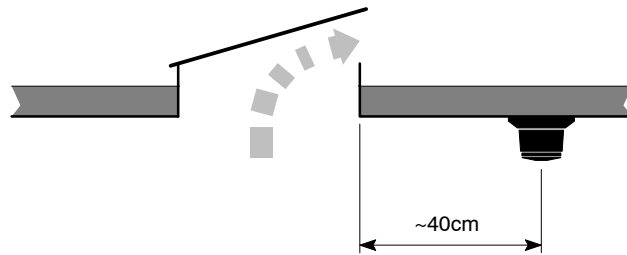

Fig. 23 Detector arrangement with unilateral ceiling ventilation

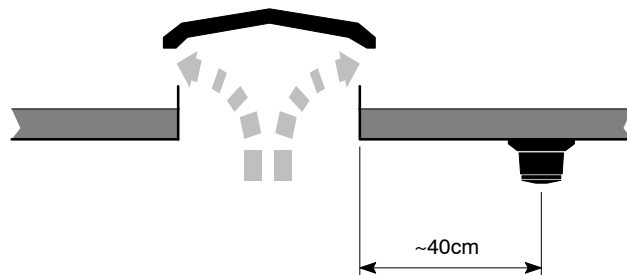

Fig. 24 Detector arrangement with bilateral ceiling ventilation

## 5.2.9 Galleries

Basically galleries or similar structures which do not allow smoke to pass should be treated in the same way. The degree to which smoke can penetrate trellis-work must be judged on the basis of the section on «Grid pattern dropped ceilings».

Detectors must be provided beneath galleries which do not permit smoke penetration, providing:

$$b > \frac{1}{4}s$$

whereby «s» must be calculated from the monitoring area in relation to room height beneath the gallery.

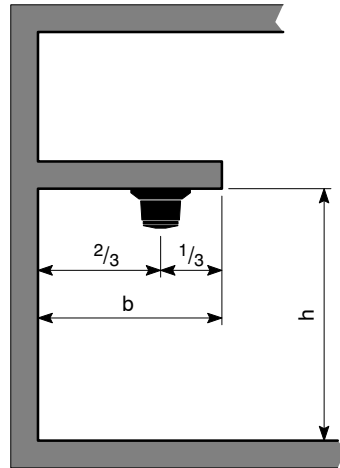

Fig. 25 Detector arrangement for a gallery without joists

If  $\frac{h'}{h} = < 0.1$

the joist can be ignored. Detectors to be arranged according to Fig. 25.

If however  $\frac{h'}{h} = > 0.1$  and  $b > 1\text{m}$

detectors must always be mounted beneath the gallery. The monitoring area must be calculated according to the room height beneath the gallery.

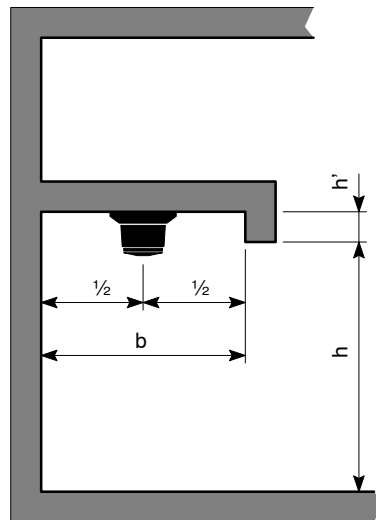

Fig. 26 Detector arrangement for a gallery with joists

## 5.2.10 Grid pattern dropped ceilings

Dropped ceilings in the form of grids, trellis-work, or slats, e.g. for decoration purposes, to act as a screen or to support light fittings, influence the spread of smoke and heat. The degree to which grid pattern dropped ceilings allow smoke penetration varies according to the size of the grid openings and the type of fire, i.e. open fire or smouldering fire.

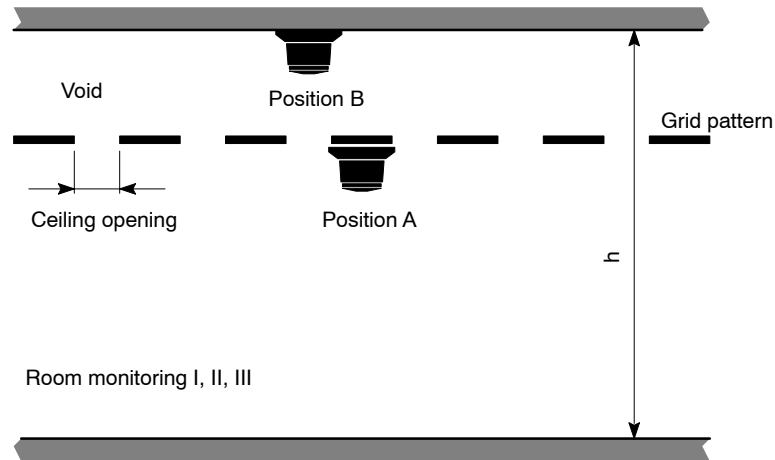

Fig. 27 Detector arrangement for a grid pattern dropped ceiling





Monitoring category	Percentage of grid ceiling opening (uniformly distributed)	Must grid openings be monitored? yes / no according to Fig. 1	Detector arrangement	
			Pos. A	Pos. B
I 	≤50%	yes	x	x
		no	x	
II 	>50%	yes or no		x
III  	≤50%	yes	x	x
		no	x	
	50 - 70%	yes or no	x	x
	>70%	yes or no	provided $h \geq 4m$ x	x

Fig. 28 Detector arrangement for a grid pattern dropped ceiling

In order to ensure response sensitivity detectors may not be mounted between the upper and lower covering layers of the grid pattern dropped ceiling, rather in the layer which forms the ceiling.

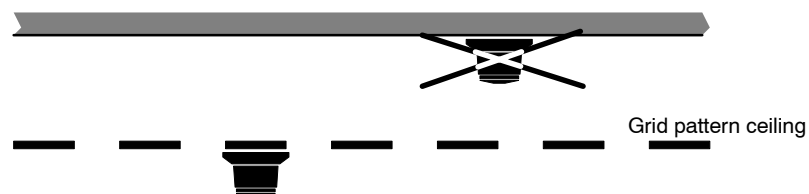

Fig. 29 Detector arrangement for on a grid pattern dropped ceiling

## 5.2.11 Ventilated / air conditioned rooms

Basically speaking, the fire detection system must be planned so that even when ventilation is switched on, monitoring is guaranteed. Smoke detectors used for room monitoring may not be installed in the path of the fresh air current of air conditioning and ventilation systems.

### Fresh air:

Fresh air supply laterally on the wall, through grilles: Detector position at least 1.5m distance from air inlets.

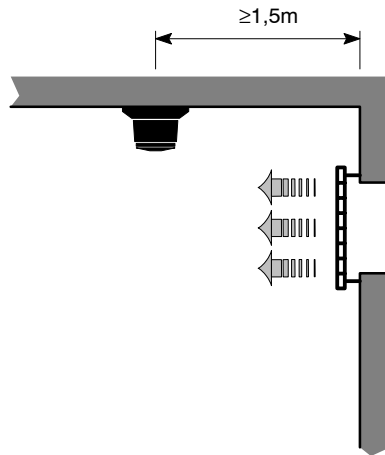

Fig. 30 Detector positions with lateral fresh air supply

Point-type ceiling fresh air inlets (diffusers etc.). Detector position symmetrically between the air inlets

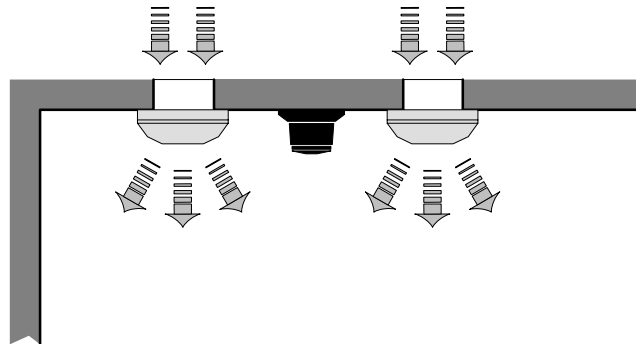

Fig. 31 Detector position with point-type air inlets on the ceiling



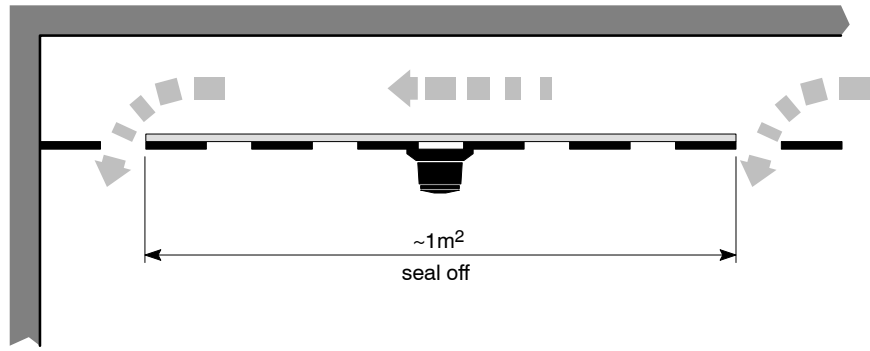

Fig. 32 Detector arrangement with fresh air ceiling vents covering a large area

**Return air:**

Point-type return air ceiling vents (diffusers etc.): Do not mount detectors in front of return air vents, rather in the turbulence zone.

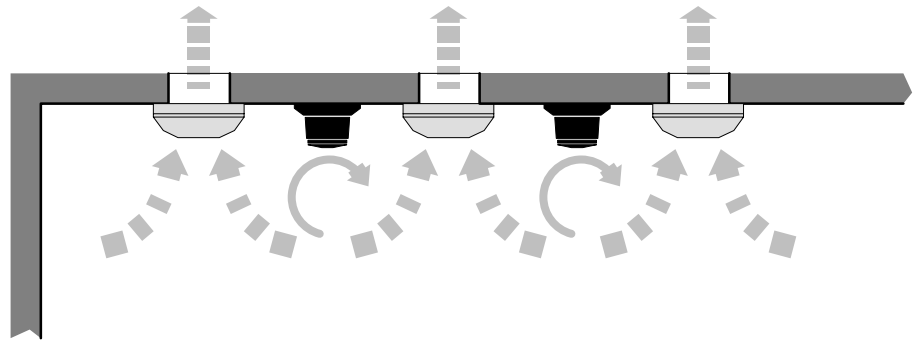

Fig. 33 Detector position with point-type return air vents

Return air vents distributed over the ceiling surface normal detector arrangement

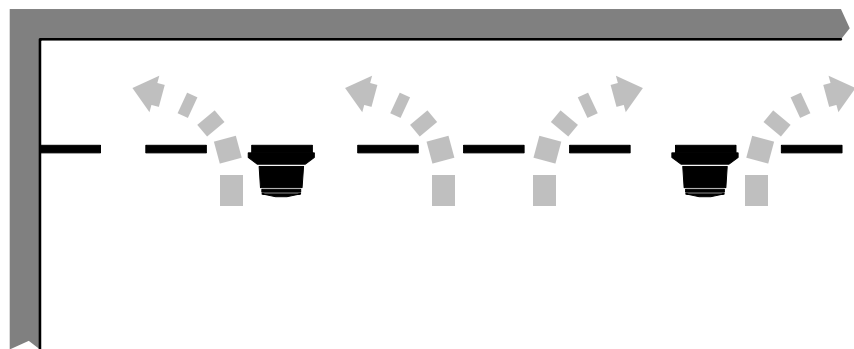

Fig. 34 Detector arrangement with return air ceiling vents spread over a large area

Return air grille in the wall directly below the ceiling: Detectors must be mounted in front of the return air grille

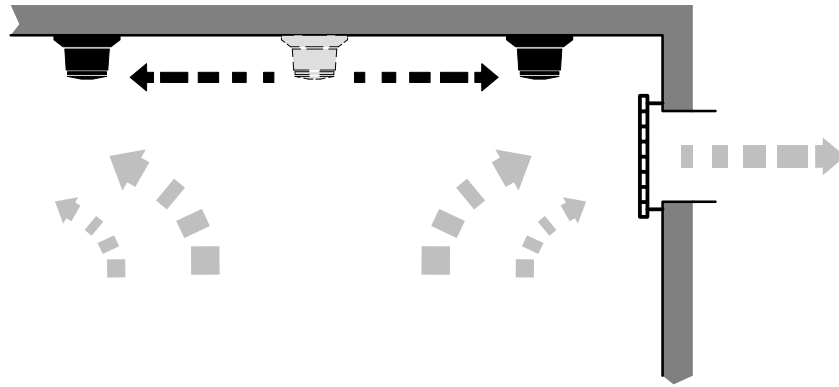

Fig. 35 Detector arrangement with lateral return air



Fig. 36 Return air vents in the wall near the floor: In addition to the detectors on the ceiling, monitoring of the return air duct with the air-sampling unit ASD-duct detector unit is recommended

## 5.2.12 Ventilation ducts

### Fresh air duct

In order to prevent smoke-logging when fire breaks out in an air conditioning or ventilation system (e.g. motor or filter fire) the air-sampling unit ASD-duct (with F smoke detectors) must obviously be installed immediately after the equipment concerned on the outgoing side.

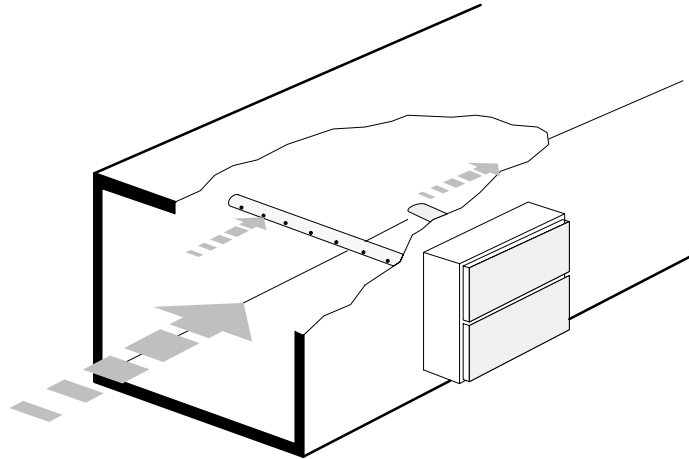

Fig. 37 Position of the air-sampling unit to monitor fresh air

### Return air duct

Monitoring of the return air duct in no way replaces monitoring of the room by detectors because room monitoring must be guaranteed even when the used air is switched off. Furthermore, the smoke from an outbreak of fire is usually diluted with smokeless return air from other areas. Thus normally only large fires are signalled by detectors in the return air duct. In spite of this the installation of the air-sampling unit ASD-duct in the return air duct is recommended for room with an air change of >30 times per hour. In order to prevent smoke being overdiluted, wherever possible the return air sectors must be monitored with the air-sampling unit ASD-duct and not just the manifold.

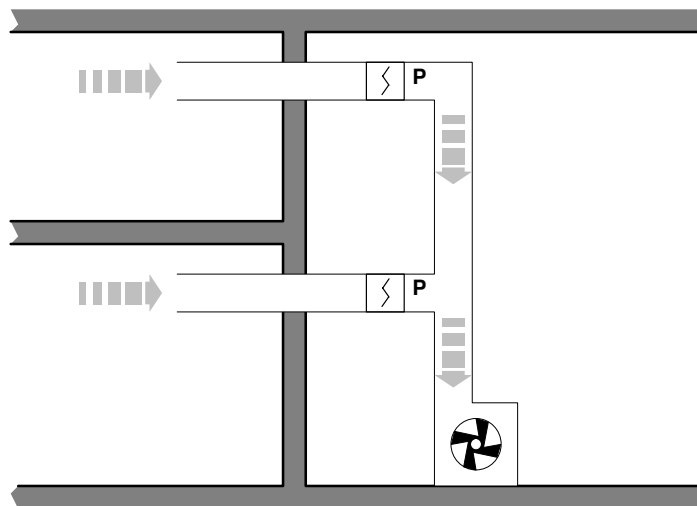

Fig. 38 Monitoring of the return air with air-sampling unit ASD-duct in the return air sectors

**Tips on installation:**

- The distance to duct change of direction or change of cross-sectional area must be approx. 1.5 times duct circumference
- Air sampling tubes should as far as possible be in the centre of the duct
- Good accessibility for service work  
**Recommendation:** Provide service hatches immediately next to the ASD-Duct
- **Minimum duct depth:**  
The tubes may not be shortened to less than 15 cm. Each tube must have at least 6 air holes (if necessary drill additional holes). Replace the end plug.

**5.2.13 Staircases**

In staircases at least one detector must be installed on the top floor ceiling. If other floors are separated from the top floor by a door, another detector must be mounted on the ceiling in front of this door. In staircases which are >12m high and have no vertical separation, an additional detector must be installed at least on every third floor or every sixth landing.

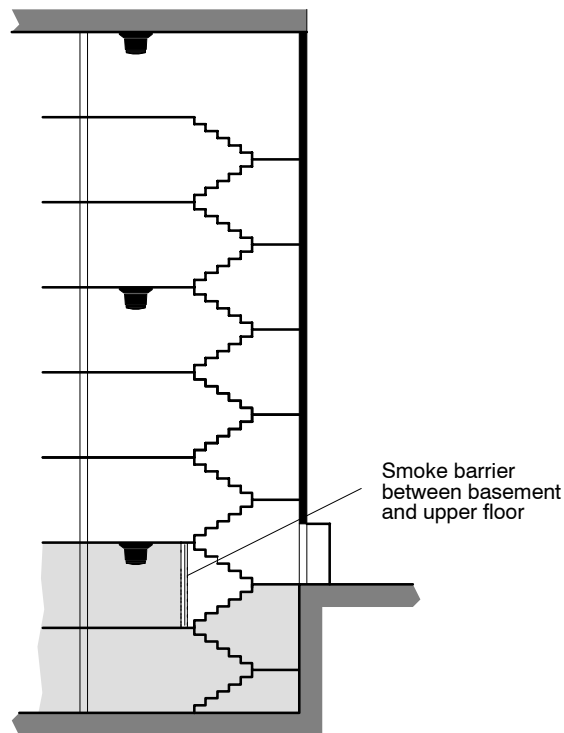

*Fig. 39* Detector arrangement in staircases

## 5.2.14 Vertical installation shafts

In vertical installation shafts, detectors must be mounted at a maximum distance apart of 8m as there is a danger that in spite of the collector plate the smoke will go past the detector. A smoke detector must always be mounted at the highest point of the shaft and in front of each horizontal fire-proof seal.

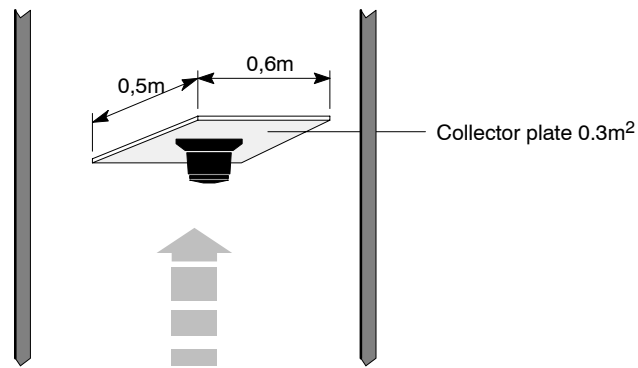

Fig. 40 Detector arrangement in vertical installation shafts

## 5.2.15 Ceiling constructions

The monitoring area and detector arrangement will vary according to the slope of the ceiling.

For practical reasons the slope of the ceiling is not given in degrees, but as a ratio of height to length of slope. This factor is called the slope (N)

**No slope:**

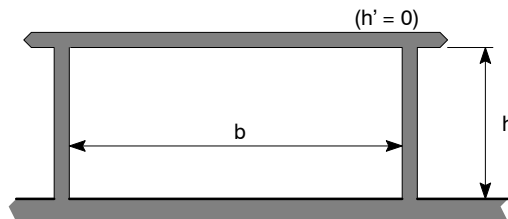

$$N = \frac{h'}{b} = 0$$

Fig. 41 Room with ceiling slope  $N = 0$   
(see section 5.3 «Detectors on flat ceilings»)

**Slight slope:**

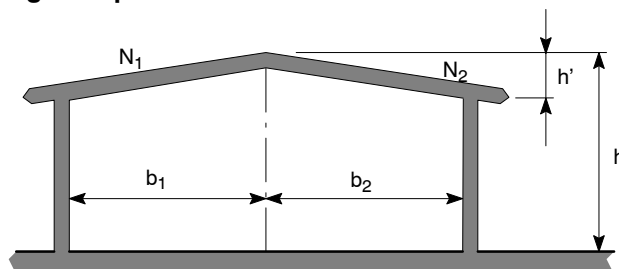
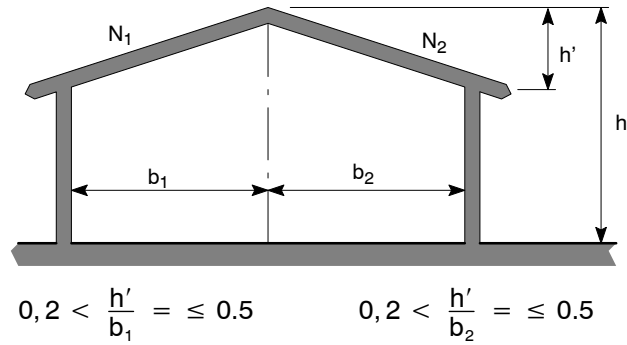

Fig. 42 Ceiling slopes  $N_1 = N_2 \leq 0.2$

Ceilings with  $N \leq 0.2$  are regarded as flat ceilings (see section 5.3 «Detectors on flat ceilings»).

If a ceiling (or roof) has surfaces with different slopes, e.g. north light roofs, then the least steep slope applies providing it is not less than  $\frac{1}{2}s$  and therefore can be ignored. If both parts of the ceiling are steeper than  $\frac{1}{2}s$ , then each part can be treated separately.

**Moderate slope:**



*Fig. 43* Ceiling slopes  $N_1 = N_2 > 0,2 \leq 0.5$  (see section 5.4 «Detectors on sloping ceilings»)

**Steep slope:**

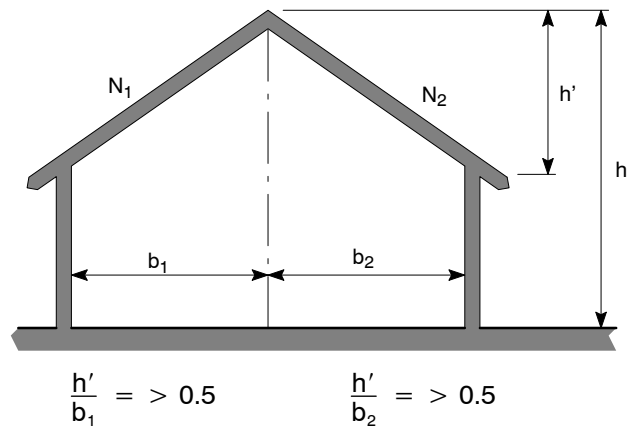

*Fig. 44* Ceiling slope  $> 0.5$  (see section 5.4 «Detectors on sloping ceilings»)

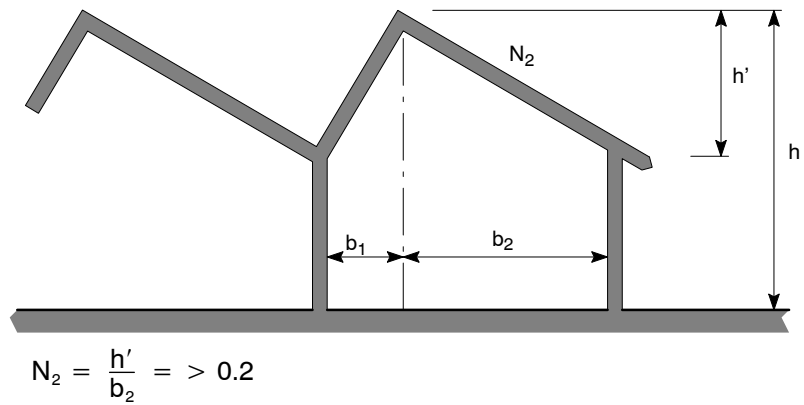

Fig. 45 Asymmetrical ceiling with  $N_2 > 0.2$

Ceilings with  $N > 0.2$  are regarded as sloping ceilings (see section 5.4 «Detectors on sloping ceilings»).

## 5.3 Smoke detectors on flat ceilings

### 5.3.1 Distance from the ceiling

Detectors must be installed at a level below where heat accumulates so that smoke can reach them unhindered. They must be spaced from the ceiling according to the table with-in the limits shown.

Room height in m	Ceiling slope (Angle $\alpha$ )	
	up to 58cm/m (up to 30°) a	from 58cm/m (from 30°) a
up to 6m	3 up to 30cm	20 up to 50cm
6 up to 7.5m	7 up to 40cm	25 up to 60cm
7,5 up to 9m	10 up to 50cm	30 up to 70cm
9 up to 12m	20 up to 80cm	50 up to 100cm

Fig. 46 Table Distance from the ceiling

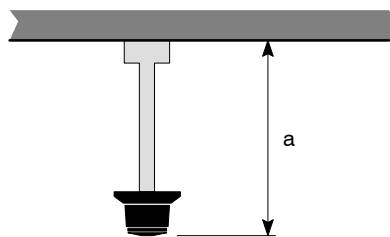

Fig. 47 Distance from ceiling of smoke-sensitive element

### 5.3.2 Monitoring area per detector

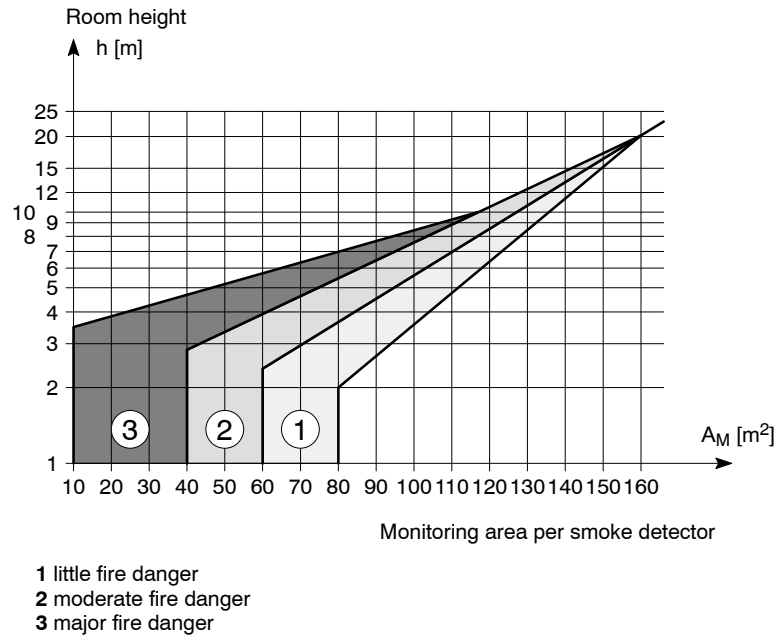

Fig. 48 Monitoring area per detector with flat ceilings

### 5.3.3 Maximum detector spacing

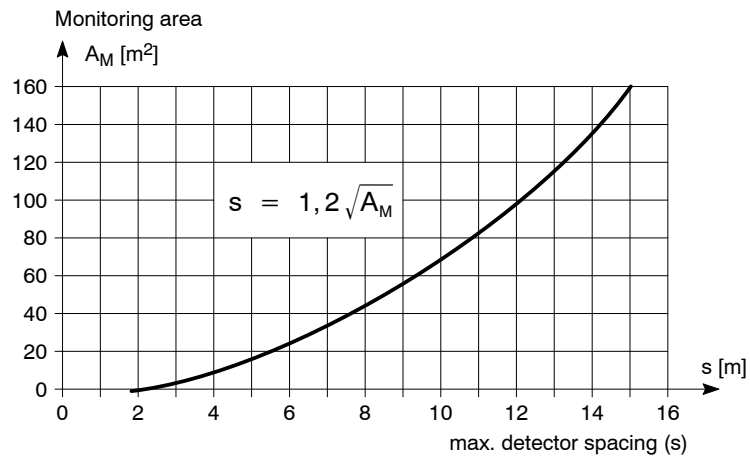

Fig. 49 Maximum detector spacing  $s$

### 5.3.4 Room space $A \leq A_M$

The detector must be mounted on the ceiling so that  $1/2 s$  is not exceeded.



### 5.3.5 Room space $A > A_M$

#### Increase of $A_M$ in rooms with an area of max. $1.33 A_M$

If the area of the room to be monitored is no more than 1/3 larger than the monitoring area per smoke detector, the monitoring area  $A_M$  may also be 1/3 larger. Under such conditions, thanks to smoke accumulation 1 detector is sufficient for room monitoring. Detector spacing  $s$  in relation to the increased monitoring area must be maintained.

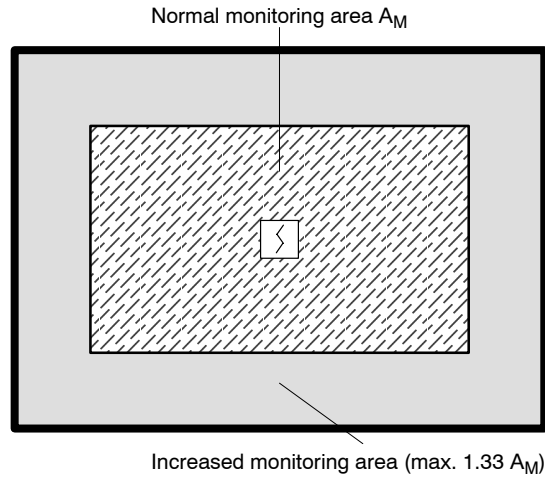
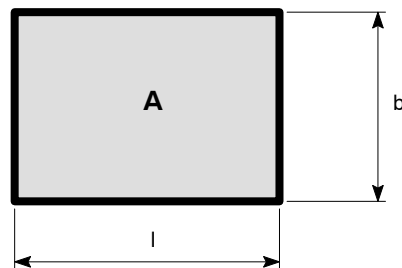

Fig. 50 Cutting down on the number of smoke detectors by utilizing smoke accumulation in the room

#### Symmetrical distribution of detectors

Once the monitoring area  $A_M$  per detector and therefore the maximum permissible spacing of detectors  $s$  is known, the symmetrical distribution of detectors in large rooms is made as follows:



Length:  $l = 55\text{m}$   
 Width:  $b = 35\text{m}$   
 Area:  $A = 55 \times 35\text{m} = 1925\text{m}^2$   
 Monitoring area:  $A_M = 100\text{m}^2$   
 Maximum detector spacing  $s = 1.2\sqrt{100} = 12\text{m}$

Fig. 51 Example of distribution of detectors

Detector distribution	Variant 1: Begin with the length	Variant 2: Begin with the width
1. Number of detectors (M) in	lengthwise direction l: $M_l = \frac{l}{s} = \frac{55}{12} = 4,58 \Rightarrow 5$	width b: $M_b = \frac{b}{s} = \frac{35}{12} = 2,9 \Rightarrow 3$
2. Effective detector spacing in	lengthwise direction l: $s = \frac{l}{M_l} = \frac{55}{5} = 11\text{m}$	width b: $s_b = \frac{b}{M_b} = \frac{35}{3} = 11,70\text{m}$
3. Max. reference measurement without exceeding $A_M$	in the width: $s_{b,max.} = \frac{A_M}{s_l} = \frac{100}{11} = 9,10\text{m}$	lengthwise: $s_{l,max.} = \frac{A_M}{s_b} = \frac{100}{11,7} = 8,50\text{m}$
4. Number of detectors (M) in	width b: $M_b = \frac{b}{s_{b,max.}} = \frac{35}{9,1} = 3,84 \Rightarrow 4$	length l: $M_l = \frac{l}{s_{l,max.}} = \frac{55}{8,45} = 6,5 \Rightarrow 7$
5. Effective detector spacing in	Width b: $s_b = \frac{b}{M_b} = \frac{35}{4} = 8,75\text{m}$	length l: $s_{lb} = \frac{l}{M_l} = \frac{55}{7} = 7,85\text{m}$
6. Check:	$s_l \times s_b \leq A_M$ $11 \times 8,75 = 96,2\text{m}^2$ i.e. $<100\text{m}^2$	$s_l \times s_b \leq A_M$ $11,7 \times 7,85 = 91,8\text{m}^2$ i.e. $<100\text{m}^2$

Fig. 52 Systematic detector distribution

Variant 1 requires  $5 \times 4 = 20$  detectors

Variant 2 requires  $3 \times 7 = 21$  detectors

The experienced planning engineer can achieve the same result with the following, simpler procedure:

**Calculate the minimum number of detectors:**

$$M_m = \frac{A}{A_M}$$

The number of detectors ( $M_m$ ) must be symmetrically distributed throughout the room concerned so that « $\frac{1}{2}s$ » is not exceeded. Moreover, the effective number of detectors is usually higher.

### 5.3.6 Narrow rooms

In narrow rooms the smoke spread is channelled. Therefore detectors may be spaced further apart. The monitoring area  $A_M$  may not be exceeded however.

Providing the room width is  $\leq \frac{1}{2}s$ , detector spacing «s» can be increased as follows:

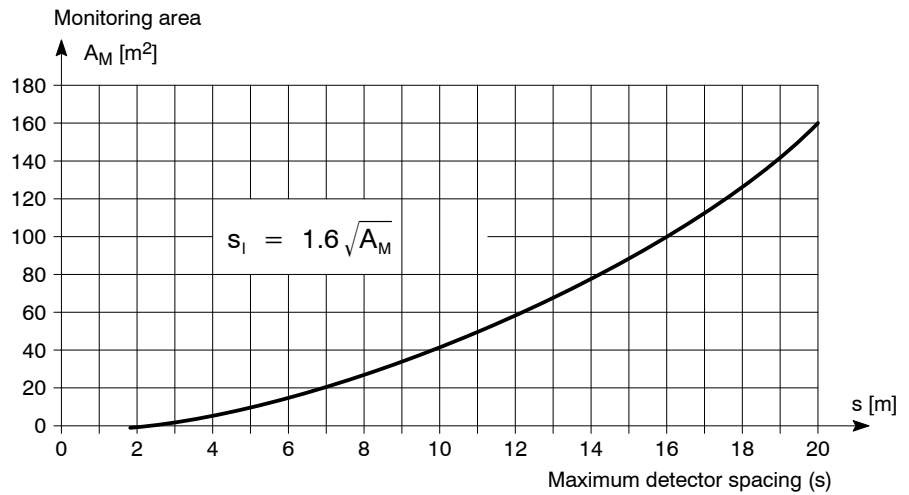

Fig. 53 Increased detector spacing

**Example:**

Monitoring area chosen  $A_M$  80m<sup>2</sup>

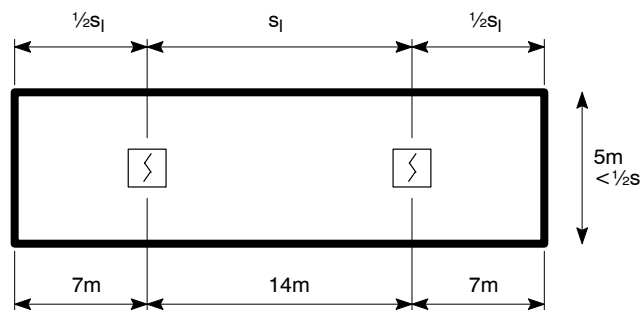

Fig. 54 Increased detector spacing

$$\frac{1}{2}s = \frac{1,2 \sqrt{80}}{2} = 5.36m = 5.4m$$

i.e. the room width is  $\ll \frac{1}{2}s$  and the lengthwise spacing may not exceed  $s_l$ .

$$s_l = 1.6 \sqrt{A_M} = 1.6 \sqrt{80} = 14.3m$$

Actual detector spacing of 7 or 14m is always slightly below the permissible maximum detector spacing.

In corridors not wider than 3m, in general detector spacing may be increased to a maximum of 15m.

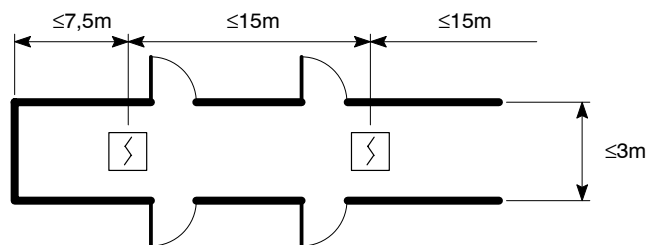

Fig. 55 Increased detector spacing in narrow corridors

One detector must always be installed at corridor junctions.

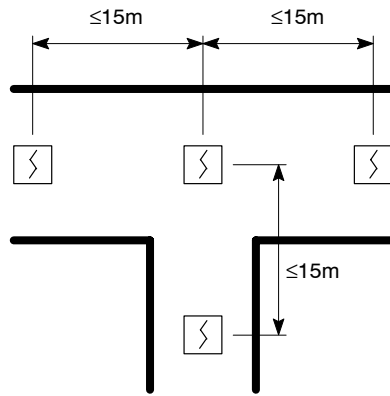

Fig. 56 Detector arrangement at a corridor junction

### 5.3.7 Joists

#### Minimum distance detector → joist

Joists obstruct the spread of smoke. The minimum distance joist → detector is 0.5m.

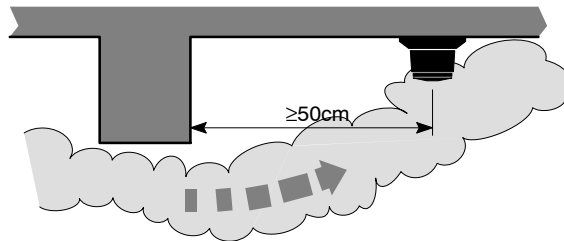

Fig. 57 Minimum distance between detector and joist

#### Obstruction of smoke spread

The deeper the joist in relation to room height and the smaller the inter-joist area in relation to the monitoring area per detector, the more smoke spread will be obstructed. With a large number of very small inter-joist areas the obstruction of smoke spread again becomes less. The obstruction of smoke spread must be taken into account by first determining the joist/room height ratio and the inter-joist ratio.

## Ratio of joist height to room height

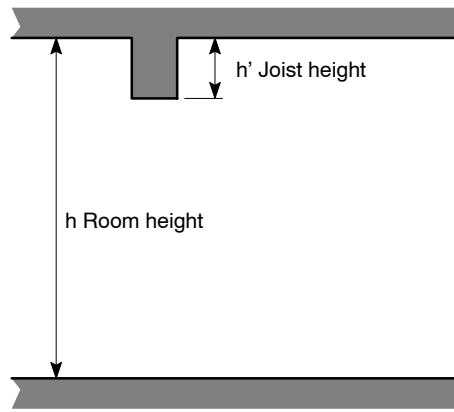

Fig. 58 Room height and joist height

$$\text{Ratio joist height/room height} = \frac{h'}{h}$$

A ratio of  $h/h' > 0.3$  counts as a room division, i.e. the joist must be regarded as a wall.

Joists with  $h' \geq 10\text{cm}$  can be ignored with the exception of the minimum spacing.

Ceilings with suspended structures or fixtures, e.g. air conditioning ducts, the upper edges of which are not closer than 15cm to the ceiling should be treated as flat ceilings. Otherwise they should be regarded as joists and treated in the same way.

## Ratio of inter-joist area to monitoring area $A_M$

The inter-joist area ( $A_U$ ) must be worked out and divided by the monitoring area  $A_M$ .

$$\text{Inter-joist area ratio} = \frac{A_U}{A_M}$$

## Detector arrangement with an inter-joist ratio of $A_U/A_M \leq 0.9$

If the ratio of joist depth to room height  $h'/h$  lies between 0.1 and 0.3, and if the inter-joist area ratio  $A_U/A_M$  is  $\leq 0.9$ , then the monitoring area  $A_M$  must be reduced as follows (otherwise see page 51).

## Correction factor K for the reduction of the monitoring area $A_M$

The reduction of the monitoring area is achieved as a function of the ratio of joist depth to room height and the ratio of inter-joist area to monitoring area and takes into consideration the obstruction of smoke spread.

The corrected (reduced) new monitoring area per detector is designated  $A_{Mk}$ .

Ratio $\frac{A_U}{A_M}$	Ratio $\frac{h'}{h}$												
	-0.05 *		0.06-0.1		0.11-0.15		0.16-0.2		0.21-0.25		0.26-0.3		>0.3
	K	P	K	P	K	P	K	P	K	P	K	P	Treat as room division, i.e. the joist forms a wall
- 0.1	0.9	P1	0.9	P2	0.9	P2	0.8	P2	0.8	P2	0.8	P2	
0.11 - 0.2	0.9	P1	0.9	P3	0.8	P3	0.7	P4	0.6	P4	0.6	P5	
0.21 - 0.3	0.9	P1	0.8	P4	0.7	P4	0.6	P4	0.5	P4	0.5	P7	
0.31 - 0.4	0.9	P4	0.8	P4	0.8	P4	0.7	P4	0.6	P5	0.5	P7	
0.41 - 0.5	1.0	P4	0.9	P4	0.8	P5	0.8	P5	0.7	P5	0.6	P7	
0.51 - 0.6	1.0	P1	0.9	P5	0.9	P5	0.8	P5	0.8	P5	0.7	P7	
0.61 - 0.7	1.0	P1	0.9	P5	0.9	P5	0.9	P5	0.8	P7	0.8	P7	
0.71 - 0.8	1.0	P1	1.0	P6	1.0	P7	0.9	P7	0.9	P7	0.9	P7	
0.81 - 0.9	1.0	P6	1.0	P6	1.0	P7	1.0	P7	1.0	P7	0.9	P7	
$\geq 0.9$	No reduction of the monitoring area, see page 51												
$A_U$ = Inter-joist area $A_M$ = Monitoring area		$h'$ = Joist height $h$ = Room height											
* Ignore joists of <10cm!													
K Correction factor													
P Arrangement													

Fig. 59 Detector arrangement on ceilings with joists ( $A_U \leq 0.9A_M$ )

The monitoring area  $A_M$  chosen on the basis of the risk and room height must be multiplied by the correction factor K shown in Fig. 59.

$$A_M \times K = A_{Mk}$$

The detector arrangement factor is given in the adjacent box.

Detector arrangement factor:

**P1** In inter-joist area or on joist

**P2** On joist or in inter-joist area at joist level

**P3** On joist

**P4** On joist, provided the width of the inter-joist area is  $\leq \frac{1}{2}s$ ; otherwise in the centre of each 2nd inter-joist area. If, as a result, detector spacing is exceeded, detectors must be arranged in a staggered (chess board) pattern in every 2nd inter-joist area, whereby a reduction of up to 15% of the number of detectors required is permissible.

**P5** On joist provided the width of the inter-joist area is  $\leq \frac{1}{2}s$ ; otherwise install one detector in each inter-joist area.

**P6** One detector in the centre of each inter-joist area, provided that  $s$  can be maintained; otherwise arrange the required number of detectors on the joists.

**P7** Install one detector in the centre of each inter-joist area, provided that the increased maximum detector spacing ( $1.6 \sqrt{A_{Mk}}$ ) is not exceeded; otherwise arrange the required number of detectors on the joists.

Application example for calculating the reduced monitoring area  $A_{Mk}$

Room height  $h$  4m

Joist depth  $h'$  1m

Monitoring area  $A_M$  80m<sup>2</sup>

Inter-joist area  $A_U$  24m<sup>2</sup>

Calculate  $A_{Mk}$

**Solution:**

1. Calculate the ratio

$$\frac{h'}{h} = \frac{1}{4} = 0.25$$

2. Calculate the ratio

$$\frac{A_U}{A_M} = \frac{24}{80} = 0.3$$

Ratio $\frac{A_U}{A_M}$	Ratio $\frac{h'}{h}$												Treat as room division, i.e. the joists forms a wall	
	-0.05 *		0.06-0.1		0.11-0.15		0.16-0.2		0.21-0.25		0.26-0.3			>0,3
	K	P	K	P	K	P	K	P	K	P	K	P		
- 0.1	0.9	P1	0.9	P2	0.9	P2	0.8	P2	0.8	P2	0.8	P2		
0.11 - 0.2		P1	0.9	P3	0.8	P3	0.7	P4	0.6	P4	0.6	P5		
0.21 - 0.3	0.9	P1	0.8	P4	0.7	P4	0.6	P4	<b>0.5</b>	<b>P4</b>	0.5	P7		
0.31 - 0.4	0.9	P4	0.8	P4	0.8	P4	0.7	P4	0.6	P5	0.5	P7		
0.41 - 0.5	1.0	P4	0.9	P4	0.8	P5	0.8	P5	0.7	P5	0.6	P7		
0.51 - 0.6	1.0	P1	0.9	P5	0.9	P5	0.8	P5	0.8	P5	0.7	P7		
0.61 - 0.7	1.0	P1	0.9	P5	0.9	P5	0.9	P5	0.8	P7	0.8	P7		
0.71 - 0.8	1.0	P1	1.0	P6	1.0	P7	0.9	P7	0.9	P7	0.9	P7		
0.81 - 0.9	1.0	P6	1.0	P6	1.0	P7	1.0	P7	1.0	P7	0.9	P7		
≥ 0.9	No reduction of the monitoring area, see page 51													
$A_U$ = Inter-joist area $A_M$ = Monitoring area * Ignore joists of <10cm! K Correction factor P Arrangement		$h'$ = Joist height $h$ = Room height												

Fig. 60 Example of detector arrangement on ceilings with joists ( $A_U \leq 0.9A_M$ )

Read off K = 0.5 in Fig. 60. Multiply the monitoring area determined  $A_M$  by this correction factor, i.e.:

$$80m^2 \times 0.5 = 40m^2 A_{MK}$$

**Guidelines for detector arrangement for inter-joist areas with a ratio of  $A_U / A_M \leq 0.9$**

**Basic information:**

Detector location depends on the ratio of joist depth to room height and ceiling geometry. The location of detectors can vary according to the size of inter-joist areas and their shape (square, rectangular, predominantly long and narrow).

Detectors must be distributed symmetrically while maintaining max. permissible detector spacing.

Maximum detector spacing must be recalculated from the reduced monitoring area.

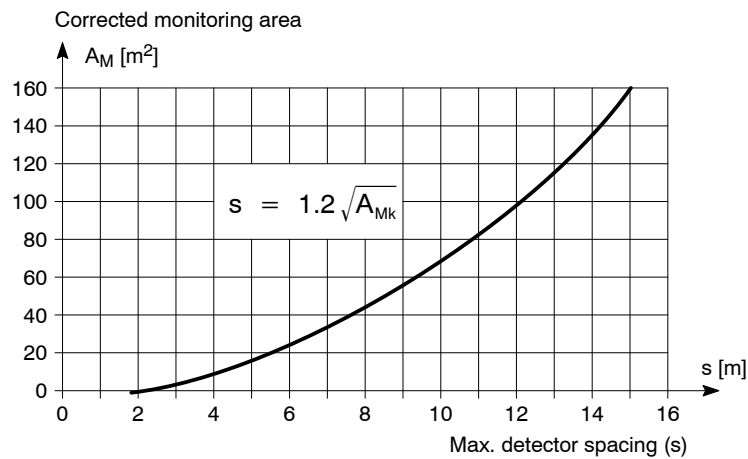

Fig. 61 Maximum detector spacing

Maximum detector spacing must always be chosen in the longitudinal direction of the inter-joist areas so that detector spacing is reduced at right angles to the joists (obstruction of smoke spread).

Oblong inter-joist areas with a ratio of  $h'/h \geq 0.1$  promote smoke spread in the longitudinal direction. Provided **one detector is mounted in each inter-joist area**, maximum detector spacing may be increased as follows:

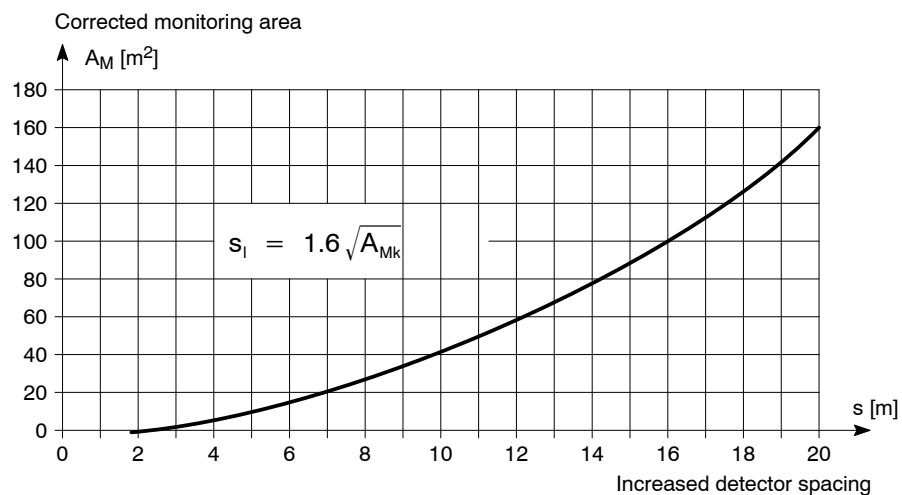

Fig. 62 Increased maximum detector spacing

### Guidelines for detector arrangement for inter-joist areas with a ratio of $A_F / A_M > 0.9$

#### Width of inter-joist area $\geq \frac{1}{2}s$

The obstruction of smoke spread by joists is negligible provided that at least one detector is mounted in each inter-joist area. The number of detectors ( $M = A/A_M$ ) must be distributed symmetrically. **Preferably**, detectors should be mounted **in inter-joist areas** or on the joists.

Detectors must therefore be distributed to comply with these conditions. This is the case if the maximum permissible detector spacing  $s$  is used in the longitudinal direction of the inter-joist area. The minimum distance detector  $\rightarrow$  joist of 0.5m must be maintained.



**Example:**

$A_M 100m^2 / A_U 120m^2$

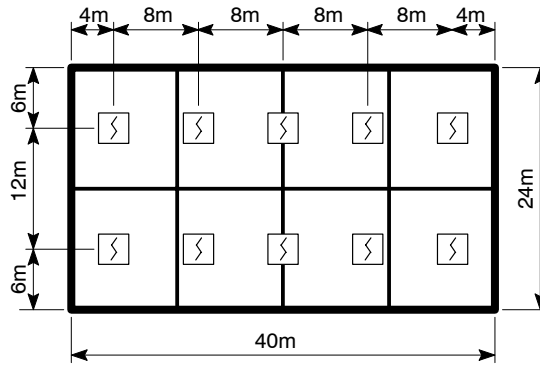

Fig. 63 Example of detector arrangement on ceilings with joists ( $A_U > 0.9 A_M$ )

**Width of inter-joist area  $< \frac{1}{2}s \geq \frac{1}{4}s$**

**$h'/h \leq 0.1$**

Distribute as for flat ceilings, however, maintain minimum space between detector and joist of 0.5m.

**$h'/h > 0.1$**

Maximum detector spacing is increased in the longitudinal direction because smoke spread is promoted in this direction.

$$s_l = 1.6 \sqrt{A_{Mk}}$$

The required number of detectors ( $M = A/A_M$ ) is so arranged that each **inter-joist** area contains at least one detector. Take advantage of increased detector spacing in the longitudinal direction!

**Example:  $A_M 100m^2$**

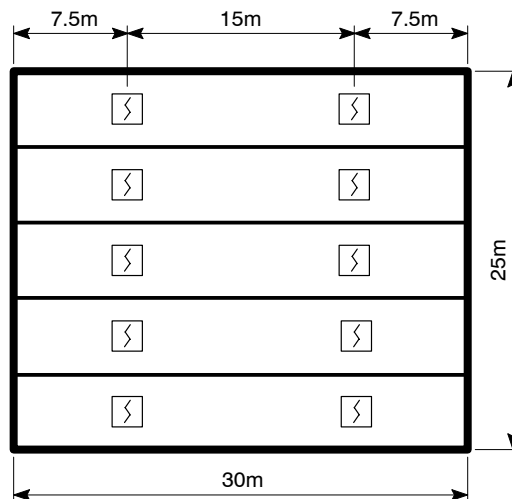

Fig. 64 Example of detector arrangement on ceiling with joists ( $A_U > 0.9 A_M$ )

If with this arrangement considerably more detectors are needed than with  $A/A_M$ , proceed as if for a inter-joist area width of  $\frac{1}{4}s$ .

**Inter-joist area width of  $\frac{1}{4}s$**

The required number of detectors ( $M = A/A_M$ ) are distributed on the joists so that  $s$  or  $1/2s$  is not exceeded.

**Example:**  $A_M$  100m<sup>2</sup>

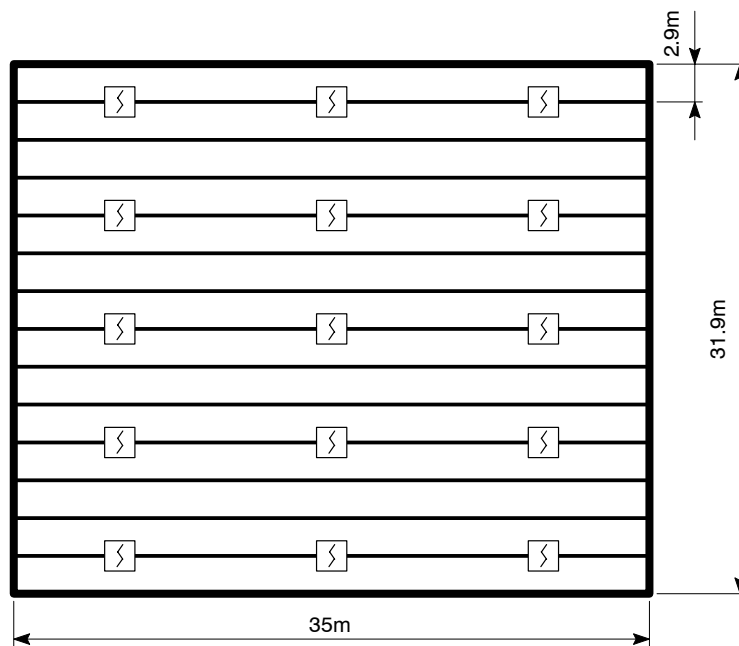

*Fig. 65* Example of detector arrangement on a ceiling with joists ( $A_U > 0.9A_M$ )

Frequently the number of joists prevents symmetrical distribution.

**Example:**  $A_M$  100m<sup>2</sup>

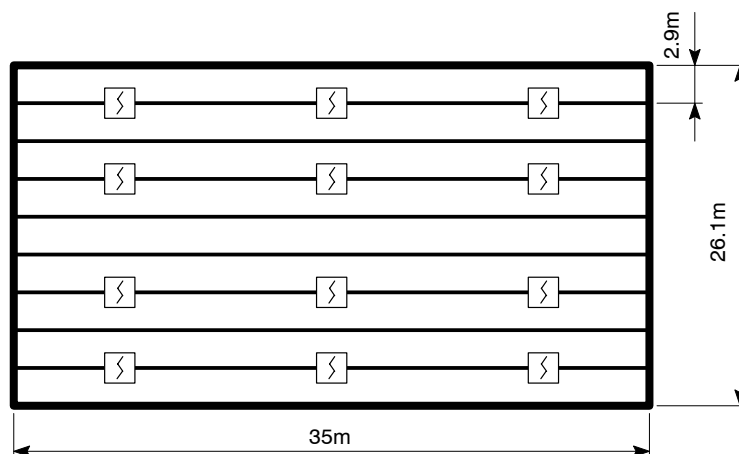

*Fig. 66* Example of an unsymmetrical detector arrangement on a ceiling with joists ( $A_U > 0.9A_M$ )

## 5.4 Smoke detectors on sloping ceilings

### 5.4.1 Smoke channelling

Sloping ceilings tend to channel smoke towards the ridge where we find the heaviest concentration of smoke. For this reason the basic area to be monitored  $A_M$  and detector spacing are increased.

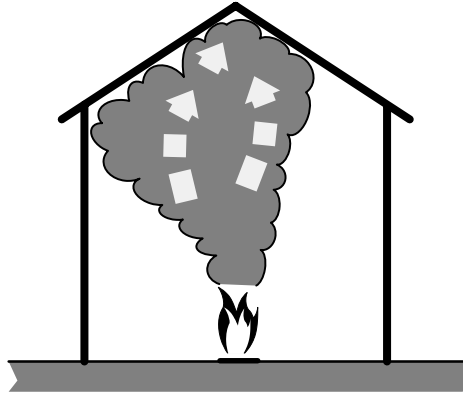

Fig. 67 Smoke channelling on a sloping ceiling

### 5.4.2 Monitoring area per detector on sloping ceilings

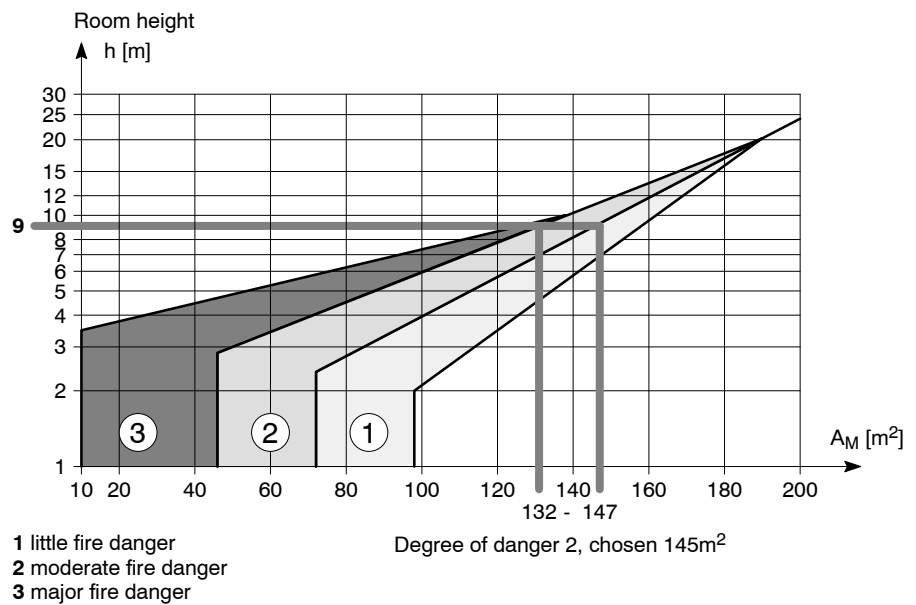

Fig. 68 Monitoring area per detector on sloping ceilings

Application example grey shaded ( $h = 9\text{m} / A_M = 145\text{m}^2$ )

### 5.4.3 Detector spacing in the vicinity of the ridge

In order that smoke can reach the detector unimpeded, the detector must be installed in the vicinity of the ridge below the level at which warm air accumulates. When dealing with ceiling structures with varying angles of slope, the longer of the two sides is decisive.

Additional rows of detectors on the slope of the ceiling (with the exception of non-insulated ceilings which in fact form the slope of the ceiling) need not be spaced. The detector must merely be mounted vertically.

Room height in m (RH)	Ceiling slope (Angle $\alpha$ )	
	up to 50 cm/m ( $N \leq 0.5$ ) distance a	from 50 cm/m ( $N \geq 0.5$ ) distance a
up to 6	3 up to 30cm	20 up to 50cm
6 up to 7.5	7 up to 40cm	25 up to 60cm
7,5 up to 9	10 up to 50cm	30 up to 70cm
9 up to 12	20 up to 80cm	50 up to 100cm

Fig. 69 Table Detector spacing in the vicinity of the ridge

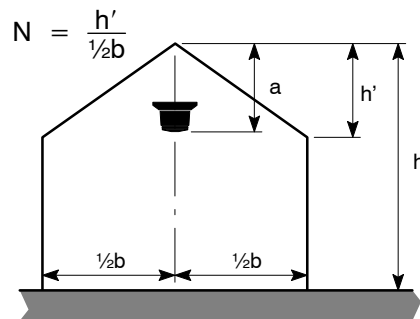

Fig. 70 Detector spacing in the vicinity of the ridge

Where the ceiling slope varies, the detector must be moved to the side with the least slope.

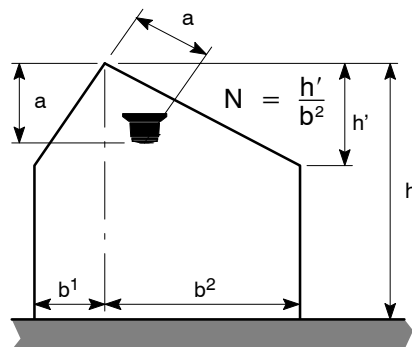

Fig. 71 Detector arrangement with asymmetrical gable roof

### 5.4.4 Reference figure for determining the required number of rows of detectors

Instead of the maximum detector spacing  $s$ , the reference figure  $z$  is used which takes into account the effect of smoke channelling with sloping ceilings.

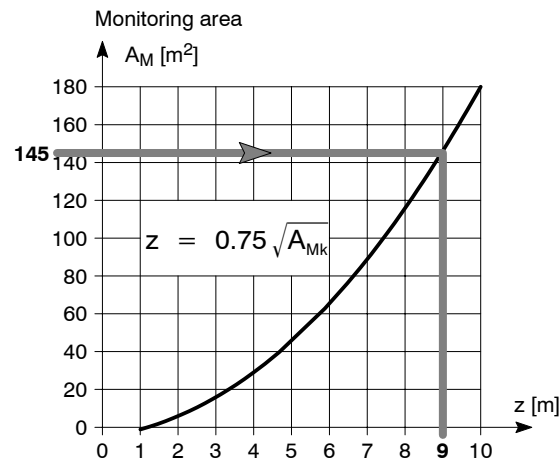

Fig. 72 Reference figure  $z$  for determining the required number of rows of detectors

Fig. 75 allows us to determine the number and spacing of rows of detectors using the reference figure  $z$ .

### 5.4.5 Rows of detectors parallel to ridge

In Fig. 73 below shows both symmetrical and asymmetrical ceiling structures with slopes of varying steepness. With asymmetrical ceilings, the shorter distance from the side wall to a vertical from the ridge is always designated  $b_1$  and the longer distance  $b_2$ . Depending on the slope of the ceiling, detectors on the slope are moved to a greater or lesser degree towards the ridge.

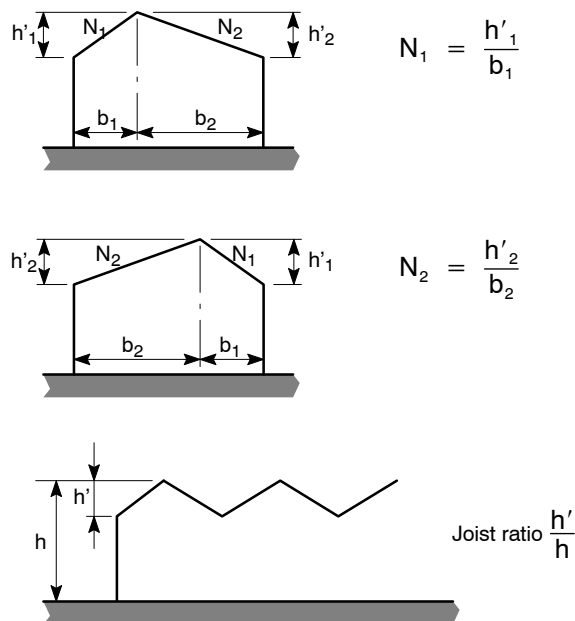

Fig. 73 Designation of building measurements for Fig. 75

The number and arrangement of rows of detectors parallel to the ridge is determined taking into account the slope of the ceiling  $N_1$  and  $N_2$  and the comparison of the two parts of the building width  $b_1$  and  $b_2$  with the reference figure z.

With very narrow buildings, the ratio room height to joist depth is taken into consideration as an additional criterion.

In Table Fig. 75 the various criteria for the comparison are shown horizontally and vertically. At the point of their intersection which meets the conditions for the comparison, we can read off the corresponding number and arrangement of detector rows.

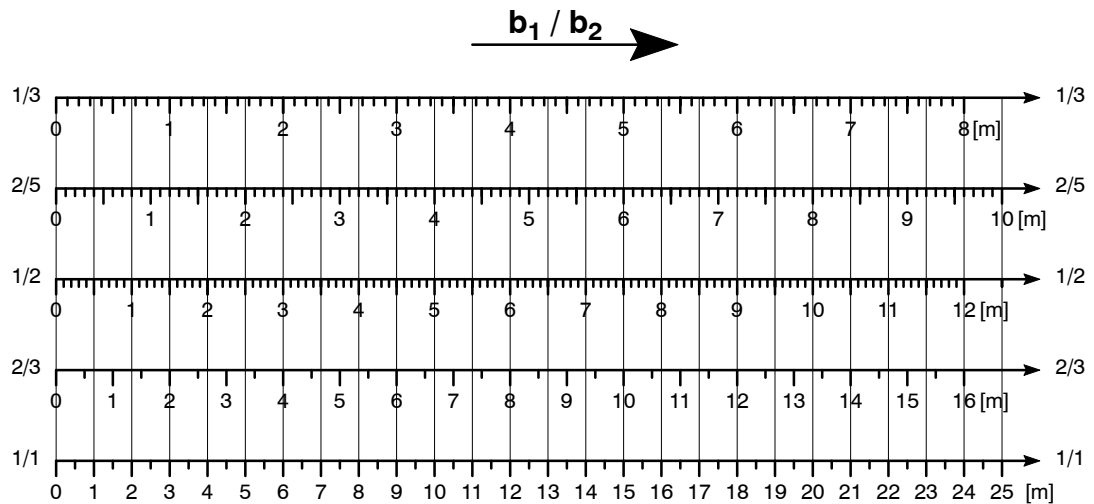
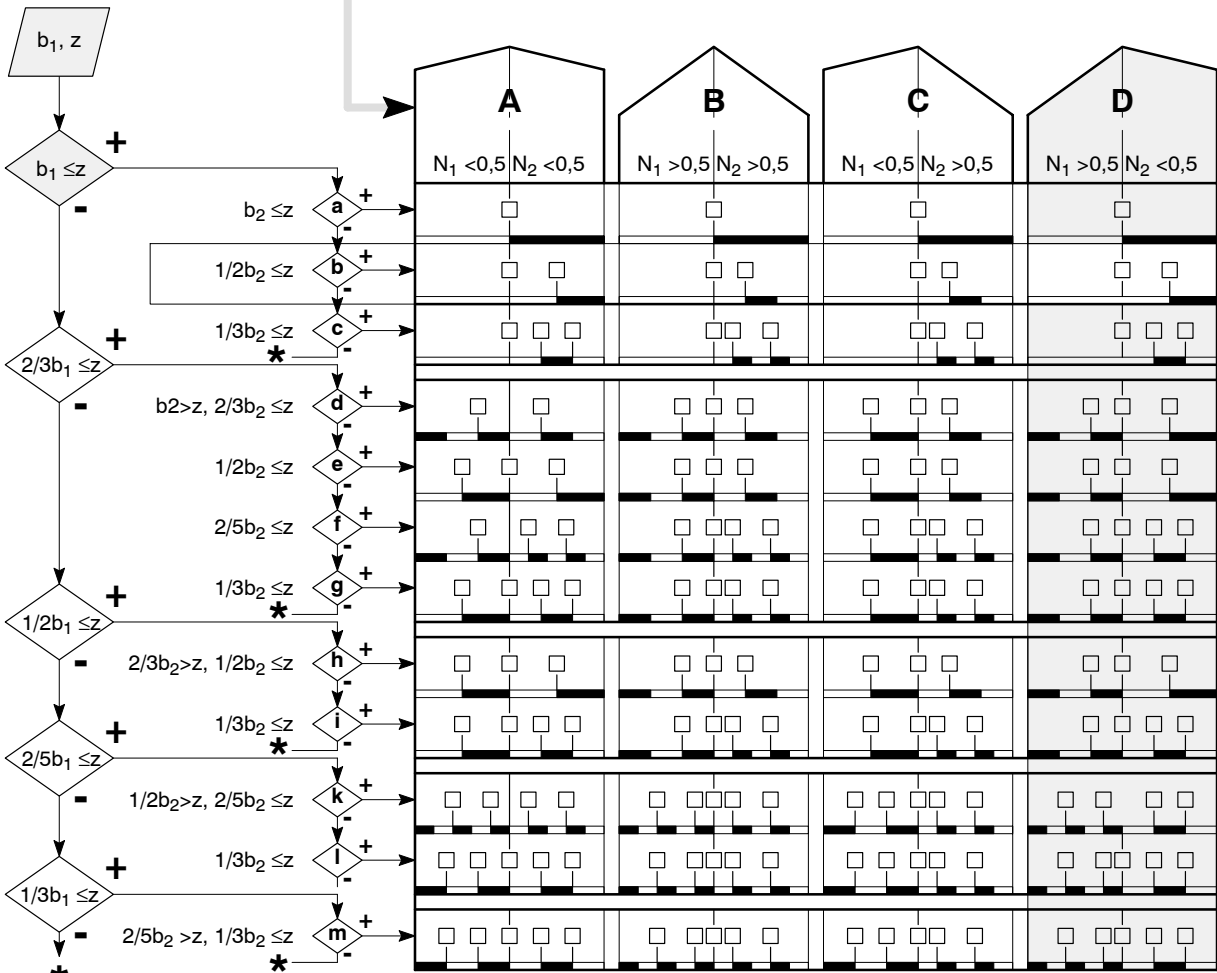
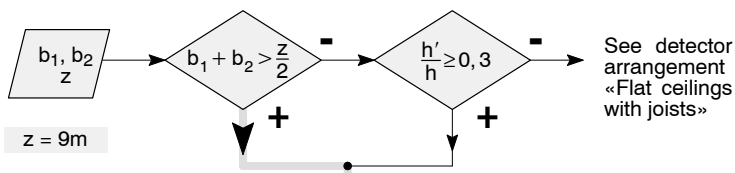
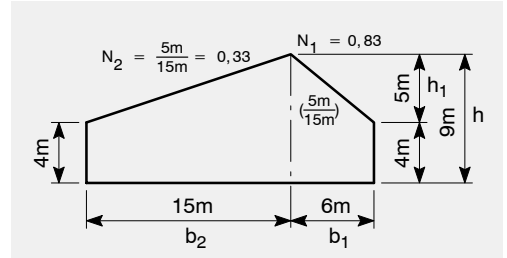

Fig. 74 Table to read off the fractions of  $b_1$  or  $b_2$

Application example:



Key: + Yes  
 - No  
 \* Special case: 3 or more lateral rows required

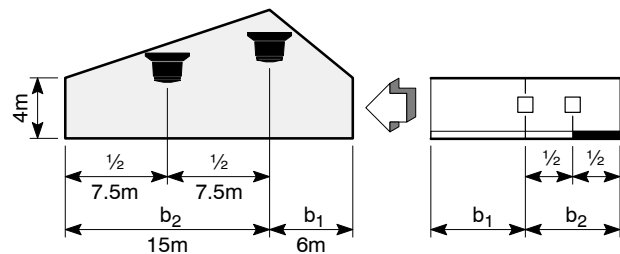
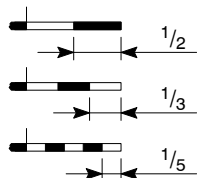
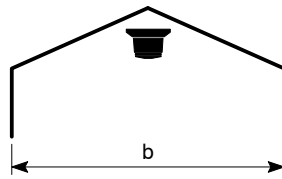

Fig. 75 Determining the required rows of detectors parallel to the ridge and their distribution over two parts of the building width  $b_1$  or  $b_2$

## 5.4.6 Symmetrical arrangement of detectors

1 row of detectors in ridge (Result from Fig. 75)



The minimum number of detectors  $M$  is calculated with  $A/A_M$ . The result is then rounded up to the nearest figure.

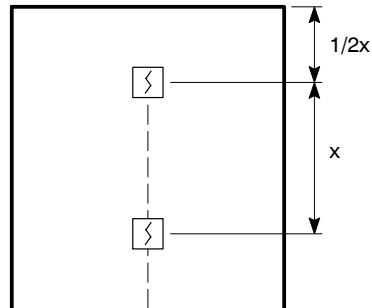

The greatest possible detector spacing  $x$  at the ridge depends on the monitoring area  $A$  and full building width  $b$  and may not exceed  $2z$ .

Fig. 76 Longitudinal arrangement of detectors with 1 row of detectors in the ridge

2 rows of detectors with no row of detectors in the ridge (result from Fig. 75)

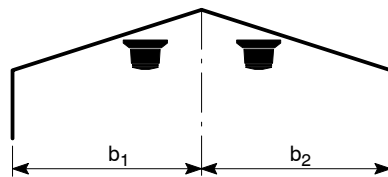

The minimum number of detectors  $M$  is calculated with  $A/A_M$ . The result is then rounded up to the nearest figure.

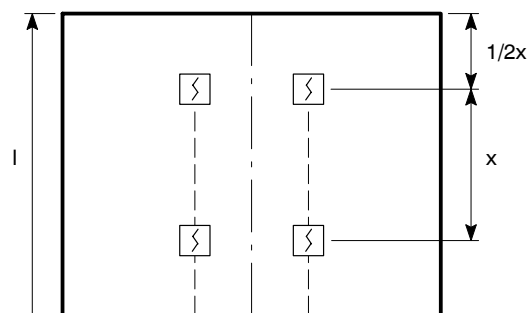

Detector spacing  $x$  is:  $x = 2 \frac{1}{M}$

Fig. 77 Longitudinal detector arrangement with 2 rows of detectors with no row of detectors in the ridge



3 rows of detectors (result from Fig. 75)

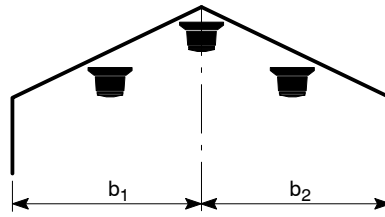

The minimum number of detectors M is calculated with  $A/A_M$ . For a practical detector arrangement the result must be corrected acc. to the following table:

Result	Detectors required M
1 - 3	3 *
4 - 5	5
6 - 8	8
9 - 11	11
12 - 14	14
15 - 17	17
18 - 20	20
etc.	etc.

\* Position all three detectors in the same axis

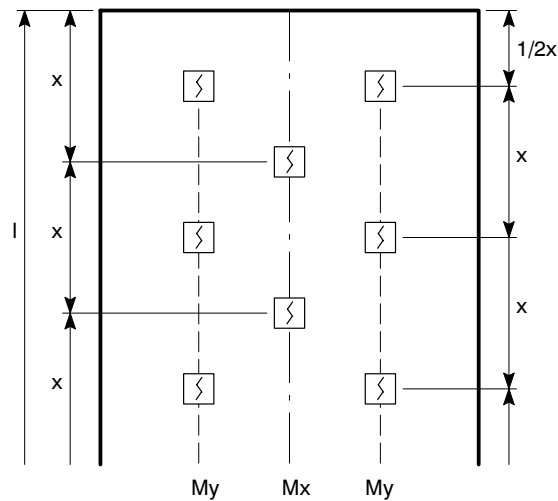

The number of detectors Mx in the ridge is:  $Mx = \frac{M - 2}{3}$

The number of detectors My in the lateral row is:  $My = Mx + 1$

Detector spacing x is:  $x = \frac{l}{My}$

Fig. 78 Longitudinal arrangement of detectors with three rows of detectors

4 rows of detectors with no row of detectors in the ridge (result from Fig. 75)

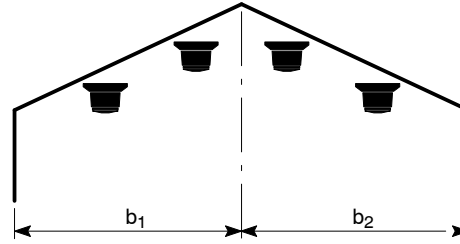

The minimum number of detectors  $M$  calculated with  $A/A_M$ . The result is then rounded up to the nearest figure which is divisible by 4.

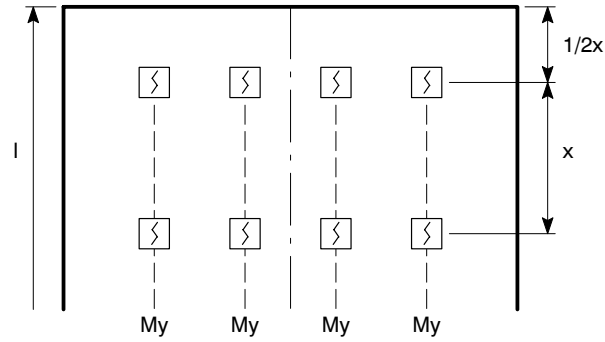

Detector spacing  $x$  is:  $x = 4 \frac{1}{M}$

*Fig. 79* Longitudinal arrangement of detectors with 4 rows of detectors with no row of detectors in the ridge

5 rows of detectors (result from Fig. 75)

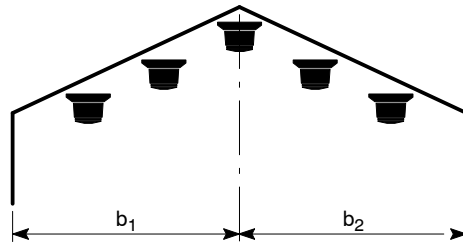

The minimum number of detectors  $M$  is calculated with  $A/A_M$ . For a practical detector arrangement the result must be corrected according to the following table whereby  $A_M$  is slightly exceeded in borderline cases:

Result	Detectors required $M$
1 - 5	5 *
6 - 7	7
8 - 13	12
14 - 18	17
19 - 24	22
25 - 29	27
etc.	etc.

\* Position all 5 detectors in the same axis

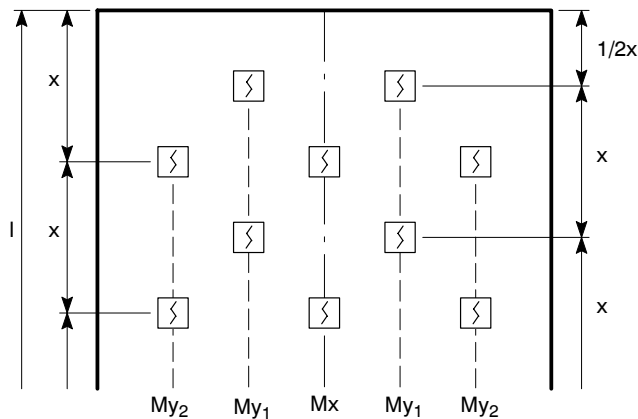

The number of detectors  $M_x$  in the ridge and in both outer lateral rows are each:  $M_x = M_y_2 = \frac{M - 2}{5}$

The number of detectors  $M_{y_1}$  in both inner lateral rows is:  $M_y = M_x + 1$

Detector spacing is:  $x = y_1 = y_2 = \frac{1}{M_{y_1}}$

Fig. 80 Longitudinal spacing of detectors with 5 rows of detectors

### 5.4.7 Asymmetrical arrangement of detectors

1 row of detectors as for symmetrical gable roof (result from Fig. 75)

2 rows of detectors (result from Fig. 75)

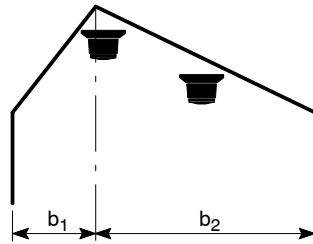

The minimum number of detectors is calculated with  $A/A_M$ . The result is then rounded up to the nearest uneven number.

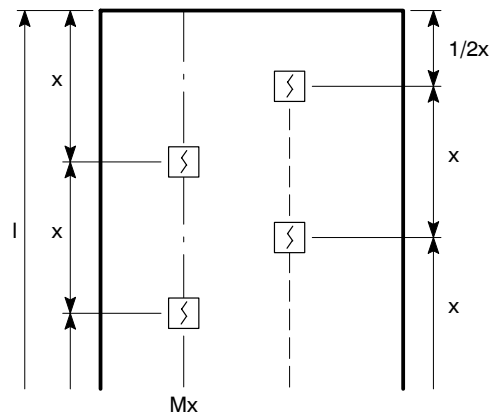

The number of detectors  $M_x$  in the ridge is:  $M_x = \frac{M - 1}{2}$

The number of in the lateral row is:  $M_y = M_x + 1$

Detector spacing is:  $x = \frac{l}{M_y}$

**Fig. 81** Longitudinal arrangement of detectors with 2 rows of detectors with a row of detectors in the ridge

3 rows of detectors with a row of detectors in the ridge (result from Fig. 75)

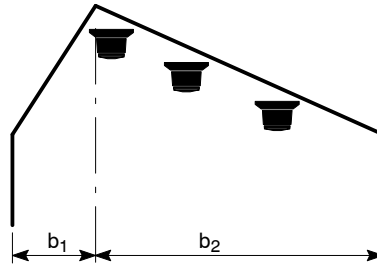

The minimum number of detectors M is calculated with  $A/A_M$ . For a practical arrangement the result must be corrected according to the following table:

Result	Detectors required M
1 - 3	3 *
4	4
5 - 7	7
8 - 10	10
11 - 13	13
14 - 16	16
17 - 19	19
etc.	etc.

\* Position all three detectors in the same axis

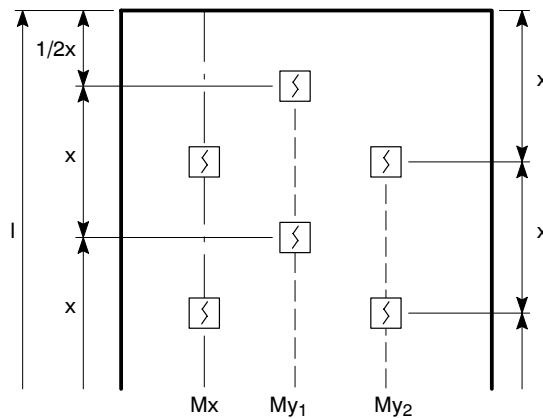

The number of detectors  $M_x$  in the ridge and in the outer lateral row  $M_{y_2}$  is each:  $M_x = M_{y_2} \frac{M-1}{3}$

The number of detectors  $M_y$  in the lateral row is:  $M_{y_1} = M_x + 1$

Detector spacing  $x$  is:  $x = \frac{l}{M_{y_1}}$

Fig. 82 Longitudinal arrangement of detectors with 3 rows of detectors with row of detectors in ridge

3 rows of detectors with no row of detectors in the ridge (result from Fig. 75)

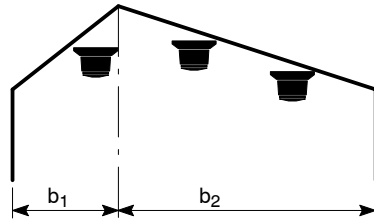

The minimum number of detectors  $M$  is calculated with  $A/A_M$ .  
The result is then rounded up to the nearest figure divisible by 3.

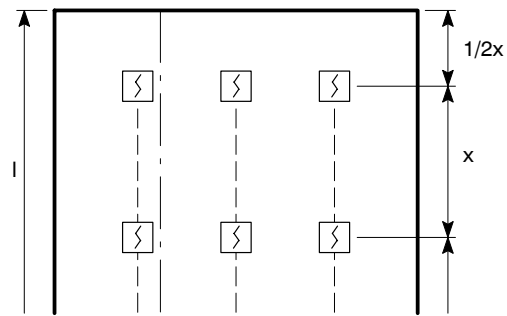

Detector spacing  $x$  is:  $x = 3 \frac{1}{M}$

*Fig. 83* Longitudinal arrangement of detectors with 3 rows of detectors with no row of detectors in the ridge

4 rows of detectors (result from Fig. 75)

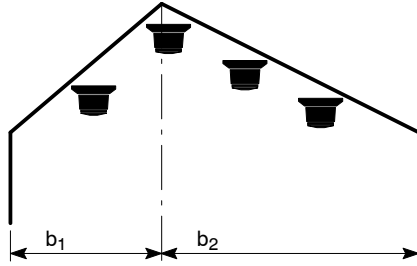

The minimum number of detectors M is calculated with  $A/A_M$ . For a practical detector arrangement the result must be corrected acc. to the following table:

Result	Detectors required M
1 - 4	4 *
5 - 6	6
7 - 10	10
11 - 15	14
16 - 19	18
20 - 24	22
25 - 28	26
etc.	etc.

\* Position all 4 detectors in the same axis

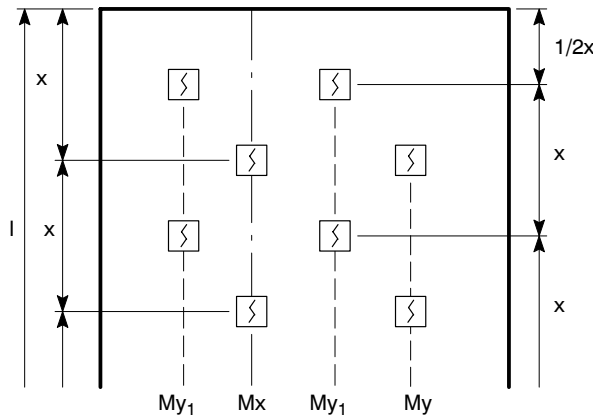

The number of detectors  $M_x$  in the ridge and in the outer lateral row are each:  $M_x = M_y \frac{M-2}{4}$

The number of detectors  $M_y$  on the two inner lateral rows is:  $M_y = M_x + 1$

Detector spacing  $x$  is:  $x = \frac{1}{M_y}$

Fig. 84 Longitudinal detector arrangement with 4 rows of detectors

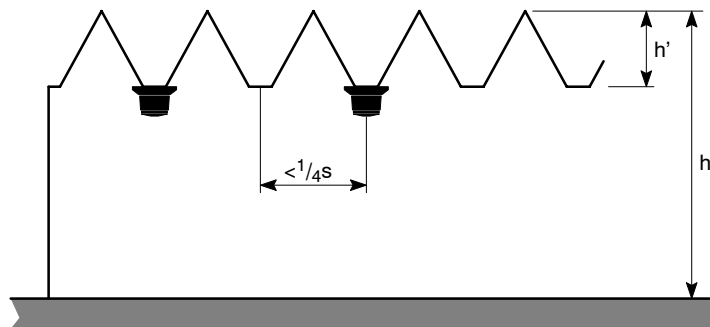

Fig. 85 Detector arrangement for special north light roofs

## 5.5 Heat detectors

### 5.5.1 No spacing from the ceiling

Unlike smoke detectors, heat detectors are mounted at the highest point of the ceiling.

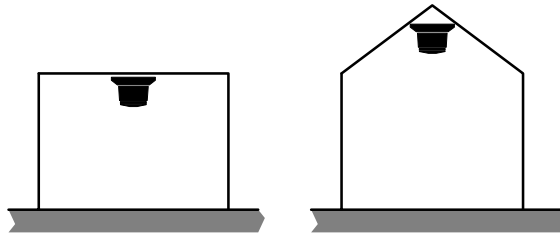

Fig. 86 Heat detector arrangement at the highest point of the ceiling

### 5.5.2 Ceiling structures / Sloping ceilings

The monitoring area and the detector arrangement is determined according to the slope of the ceiling.

For practical reasons the slope of the ceiling is not given in degrees but as a ratio of height to length of slope. This value is designated the slope (N).

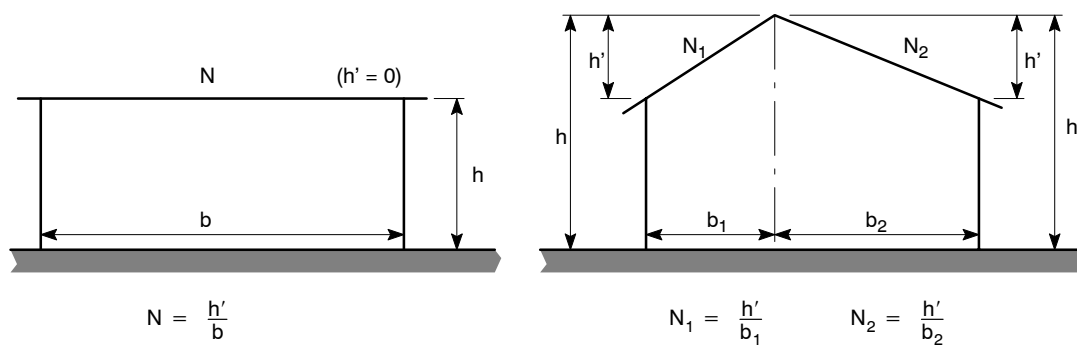

Fig. 87 Calculation of ceiling slope(s)

- $N \leq 0.2$  = flat ceiling
- $N > 0.2 \dots \leq 0.5$  = moderately sloping ceiling
- $N > 0.5$  = steeply sloping ceiling



### 5.5.3 Heat channelling

With sloping ceilings, heat travels across the slope of the ceiling to the highest point. This creates a concentration of heat in the ridge. For this reason the basic monitoring area  $A_M$  and detector spacing are increased.

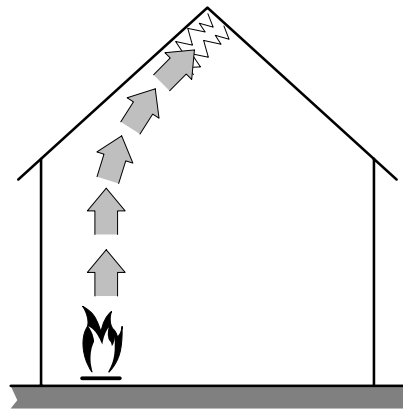

Fig. 88 Flow of heat to the highest point on the ceiling

### 5.5.4 Monitoring area and maximum detector spacing

The temperature increase at the ceiling directly above the seat of the fire falls by the square of the room height. For this reason the monitoring area per heat detector is smaller than for smoke detectors.

The maximum permissible distance from detector to detector ( $s$ ) or detector to wall ( $1/2s$ ) depends on the monitoring area and the slope of the ceiling.

Area of the room to be monitored	Maximum monitoring area ( $A_M$ ) and maximum detector spacing ( $s$ )					
	Slope of ceiling $N^*$					
	$\leq 0.2$		$> 0.2 \dots \leq 0.5$		$> 0.5$	
	$A_M$	$s$	$A_M$	$s$	$A_M$	$s$
$\leq 30\text{m}^2$	$30\text{m}^2$	7.80m	$30\text{m}^2$	9.20m	$30\text{m}^2$	10.60m
$> 30\text{m}^2$	$20\text{m}^2$	6.60m	$30\text{m}^2$	9.20m	$40\text{m}^2$	12.00m

Fig. 89 Table Monitoring areas and detector spacing for heat detectors

\* If a ceiling (or roof) has surfaces with varying slopes, e.g. north light roofs, then the one with the least slope is determinative provided it is not shorter than  $1/2s$  and therefore can be ignored. If both halves of the ceiling are  $1/2s$ , then each half can be calculated separately.

### 5.5.5 Symmetrical detector arrangement

A symmetrical detector arrangement is the same as for smoke detectors (section 5.3.5).

### 5.5.6 Minimum detector spacing

The distance between detectors and walls, fixtures and fittings and stored goods may not be less than 0,5m, except for corridors, ducts and similar parts of buildings of less than 1m in width. If there are joists, beams or e.g. air conditioning ducts running below the ceiling, which are closer to the ceiling than 0.15m, then detectors must be spaced at least 0.5m laterally from these structures.

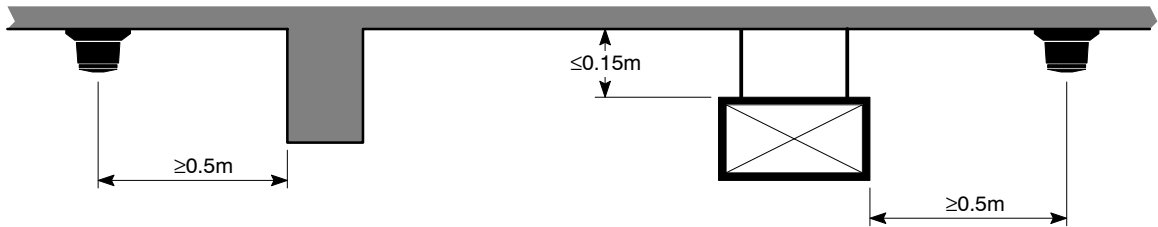

Fig. 90 Spacing detectors from installation fittings

### 5.5.7 Racks, stored goods

Stored goods or racks which extend to within less than 0.3m of the ceiling obstruct the spread of heat to such an extent that they must be regarded as room divisions (walls).

Room division =  $h' < 0.3\text{m}$

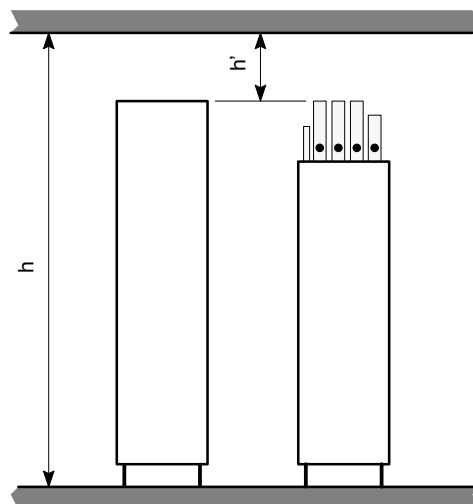

Fig. 91 Room divided by racks or stored goods

## 5.5.8 Raised roof structures

Raised roof structures which are connected to the room to be monitored and whose surface area exceeds 10% of the total ceiling area, or as long as this part of the ceiling is  $A_M$ , must be regarded as separate rooms. If not, they can be disregarded.

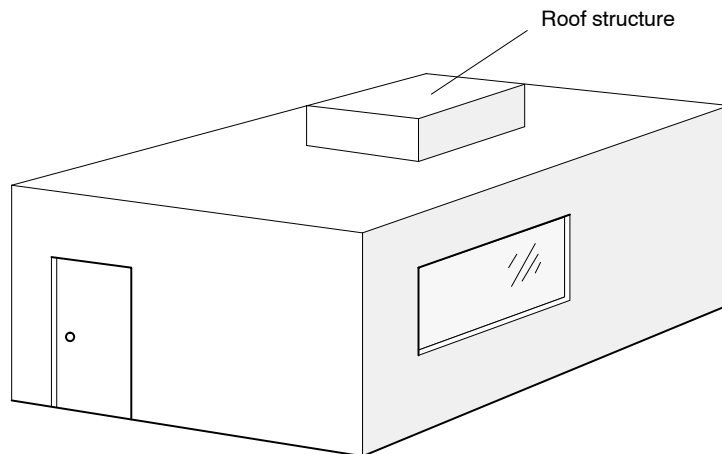

Fig. 92 Room with raised roof structure

## 5.5.9 Ceiling ventilation

With ceiling ventilation (Cupolex, «mushroom» vents etc.) detectors may be installed near the vents provided this is permitted by the arrangement of the vents, the area to be monitored and the maximum detector spacing.

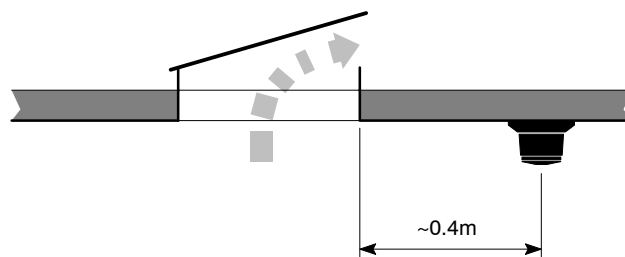

Fig. 93 Detector arrangement with unilateral ceiling ventilation

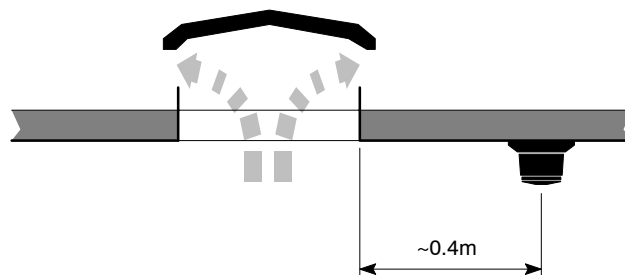

Fig. 94 Detector arrangement with bilateral ceiling ventilation

## 5.5.10 Galleries

Basically, galleries or similar structures which suppress the influence of heat flow should be treated in the same way. The permeability of the flow of heat through trellis constructions must be assessed as under the section «Grid pattern dropped ceilings» (5.5.13).

Detectors must be provided beneath galleries without heat flow permeability provided:

$$b > 1/4s$$

whereby the monitoring area  $s$  must be based on the room height beneath the gallery.

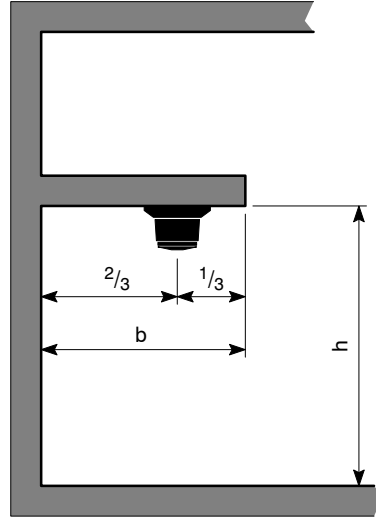

Fig. 95 Detector arrangement beneath a gallery

If  $\frac{h'}{h} = < 0.1$

the joist can be disregarded. Detector arrangement according to Fig. 94.

However, if  $\frac{h'}{h} = \text{is} > 0.1$  and  $b > 1$

detectors must always be provided beneath the gallery. The monitoring area must be calculated according to the room height beneath the gallery.

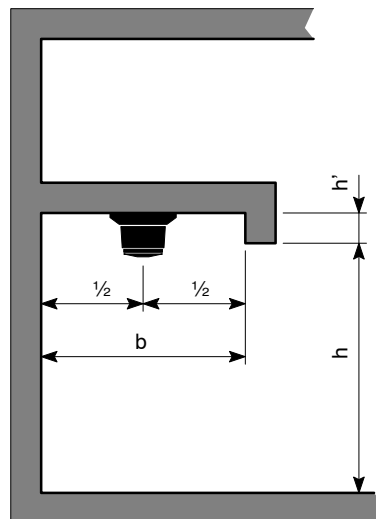

Fig. 96 Detector arrangement for a gallery with joist

### 5.5.11 Ventilated / air conditioned rooms

Detectors for room monitoring may not be installed in the path of the fresh air current from air conditioning and ventilation systems. Perforated ceilings which provide ventilation must be sealed around the detectors.

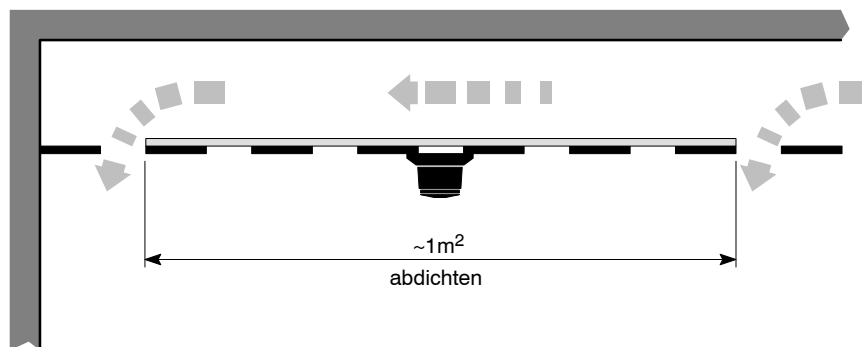

Fig. 97 Sealing a perforated ceiling

### 5.5.12 Narrow rooms / corridors

In narrow rooms or corridors not wider than 3m, detector spacing may in general be increased to 10m. The maximum permissible monitoring area may, however, not be exceeded. A detector should always be installed at the junction of corridors.

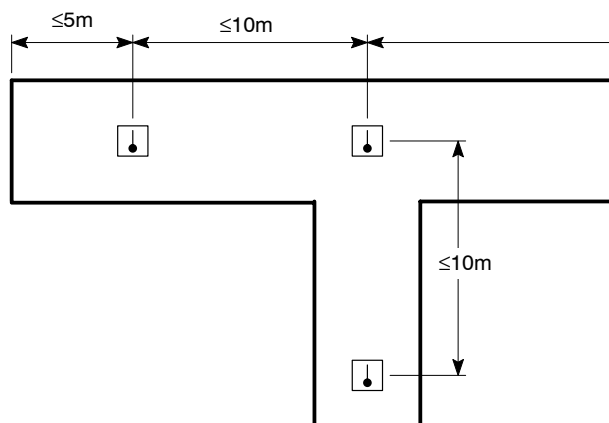

Fig. 98 Detector arrangement in narrow rooms / corridors

### 5.5.13 Grid pattern dropped ceilings

Dropped ceilings which form a grid pattern, e.g. for purposes of decoration, to diffuse light, or to support light fittings, influence the spread of heat. The heat permeability of grid pattern dropped ceilings varies according to the percentage of space taken up by the openings and the nature of the openings themselves.

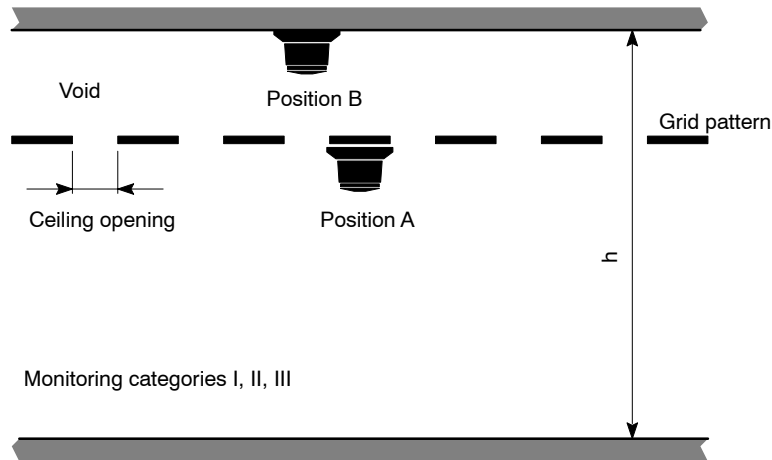

Fig. 99 Detector arrangement with grid pattern dropped ceilings

% of space taken up by openings (evenly distributed)	Size of opening		Must the void be monitored? yes/no according to Fig. 1	Detector arrangement	
	small, e.g. 1cm slits	large, e.g. 2cm slits or larger		Pos. A	Pos. B
>50%	yes or no	yes or no	yes or no		X
>25% ... 50%	yes	no	no	X	
	yes	no	yes	X	X
	nein	yes	yes or no		X
<25%	yes or no	yes or no	no	X	
			yes	X	X

### 5.5.14 Joists

Joists must be taken into account according to room height and depth of joist.

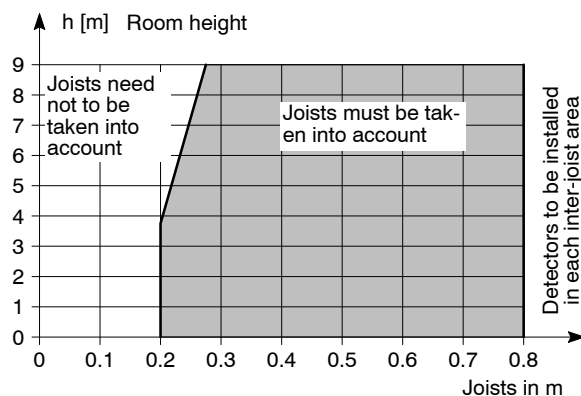

Fig. 100 Determining whether joists must be taken into account

If they have to be taken into account refer to the following table Fig. 101:

Maximum monitoring area		Size of inter-joist area	Mount one detector in each
Heat detector	20m <sup>2</sup>	>12m <sup>2</sup> 8 - 12m <sup>2</sup> 6 - 8m <sup>2</sup> 4 - 6m <sup>2</sup> <4m <sup>2</sup>	1.JA* 2. IJA 3. IJA 4. IJA 5. IJA
	30m <sup>2</sup>	>18m <sup>2</sup> 12 - 18m <sup>2</sup> 9 - 12m <sup>2</sup> 6 - 9m <sup>2</sup> <6m <sup>2</sup>	IJA 2. IJA 3. IJA 4. IJA 5. IJA

\* IJA = Inter-joist area

Fig. 101 Detector arrangement where joists have to be taken into account

### 5.5.15 Sloping ceilings (N >0.2)

If the slope of the ceiling N is >0.5, then one row of detectors must be installed in the ridge or the highest part of the room.

Other rows of detectors on the slope of the ceiling are inevitable if the permissible detector spacing s is maintained. Detectors in the lateral row are slightly offset towards the ridge, i.e. the distance from detector to wall should be the same as from detector to detector.

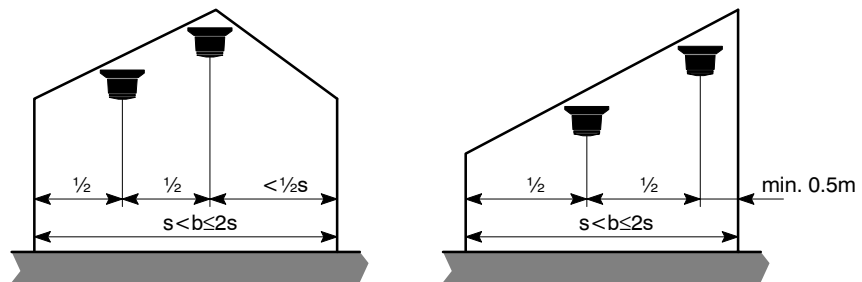

Fig. 102 Arrangement of detector rows with a ceiling slope of N >0.5

If the slope of the ceiling N lies between 0.2 and 0.5m, a row of detectors in the ridge can be waived. The rows of detectors are heavily offset towards the ridge.

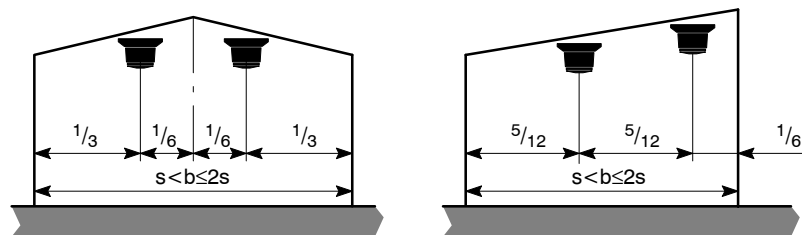
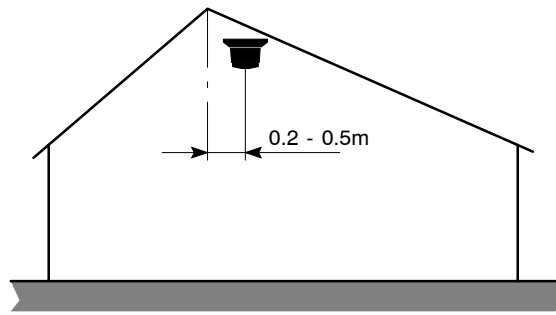

Fig. 103 Arrangement of detector rows with a ceiling slope of N from 0.2 up to 0.5

For ceilings with varying slopes, the row of detectors in the ridge is installed on the least steep slope. The greater the variation in slope, the more the row of detectors must be offset.



*Fig. 104* Detector arrangement in the ridge with varying slope of ceiling

For north light roofs, detectors can be mounted as for roofs with joists where the roof structures are less than  $1/4s$  provided  $\frac{h'}{h} = \leq 0.3$ .  $h$  The monitoring area  $A_M$  must in this case be calculated as for a **flat ceiling**.



## **5.6 Flame detector S2406**

The description and planning are contained in document e164 «Infrared flame detector» in the DS24 manual, section 2.

## **5.7 Linear smoke detector DLO1191**

The description and planning are contained in document e1276 «Linear smoke detector» in the DS11 manual, section 3.

## **5.8 Air sampling smoke detection**

The description of and planning for the following products are contained in the corresponding documents.

- «ASD-Duct» DBZ1197A: Document x1367, manual DS11, section 3
- «ASD-Flex», «ASD-Mono», «ASD-Modular»: Manual DS24, section 5
- HSD2400: Document e993, manual DS24, section 5

## 5.9 Manual call points

### 5.9.1 Number and locations

Manual call points must be installed where they are clearly visible along escape routes, e.g.

- Exits
- Corridors
- Staircases
- Lift foyers
- Entrance halls
- Hose cabinets
- particularly hazardous areas

at intervals of not more than 40m.

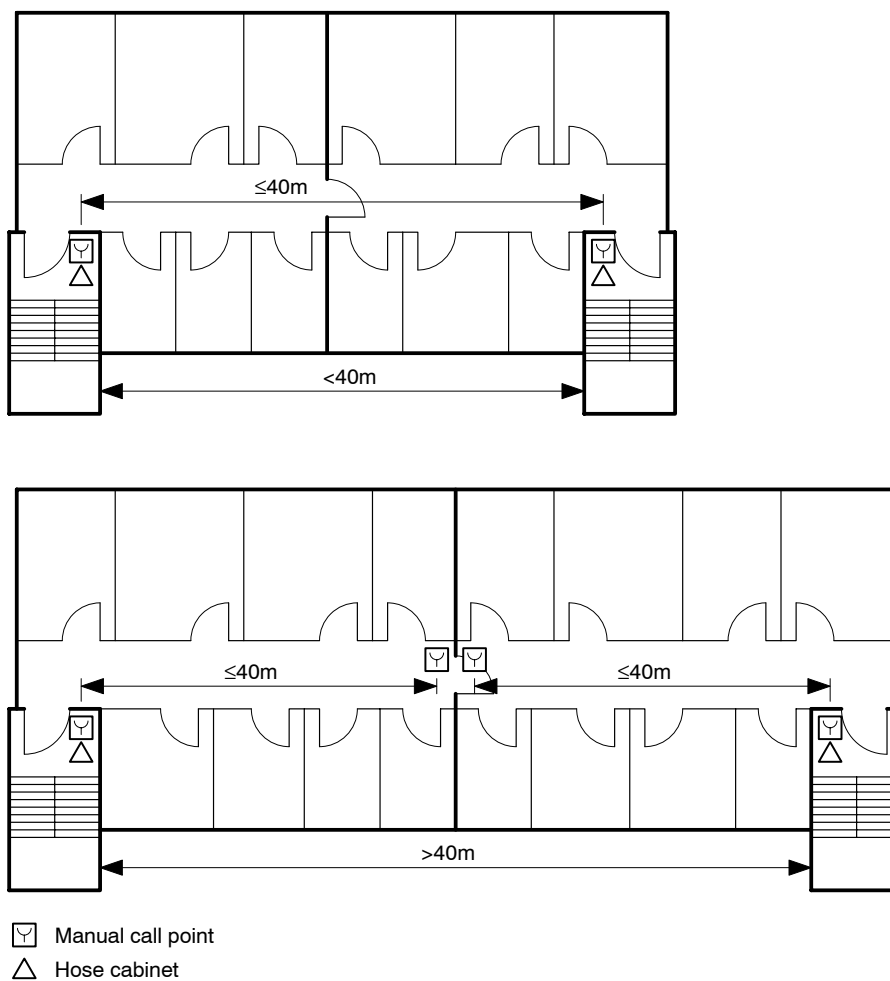
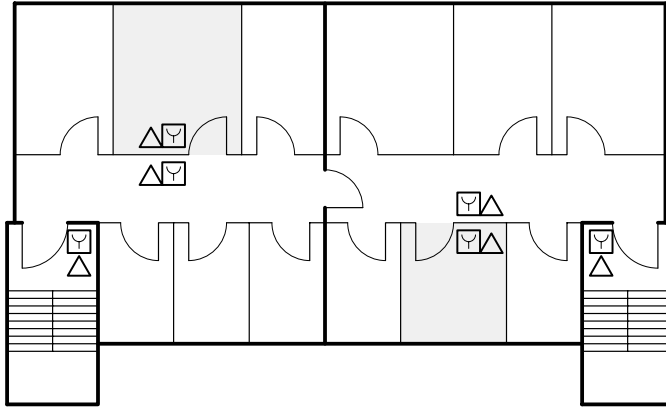

Fig. 105 Locations of manual call points along escape routes



*Fig. 106* Locations of manual call points in rooms with increased fire danger

Zones of manual call points without mechanical self hold may not be operated via intermediate alarm memories.

## 5.9.2 Mounting height

In general manual call points should be mounted at a height of 1.5 to 1.7m from the floor. This prevents unwanted operation (e.g. confusion with light switches in the dark).

They may be mounted at a lower height when built into hose cabinets or control desks.

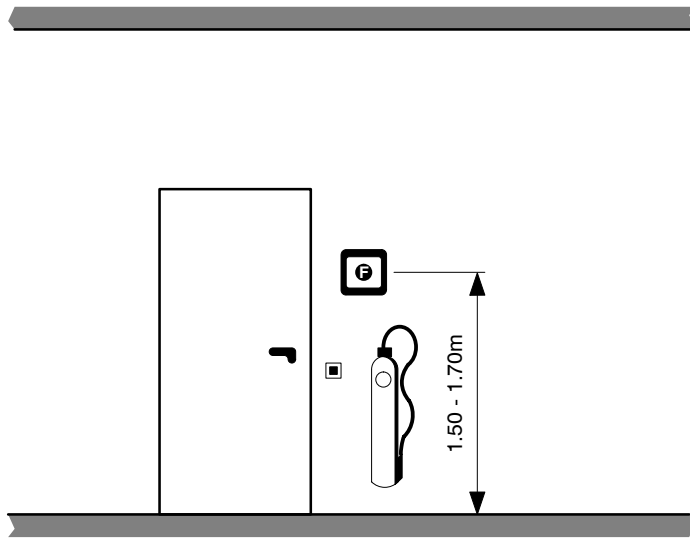

*Fig. 107* Mounting height of manual call points

# 6 Detector zones and detection lines

## 6.1 Terminology

A **detector zone** is a group of detectors connected in one detection line, for which **an indicator (fire location indicator) is provided at the control unit.**

The **detection line** is the monitored electrical transmission line which connects the **fire detectors to the control unit.**

## 6.2 Formation of detector zones

### 6.2.1 Automatic fire detectors

The entire monitoring zone must be divided up into detector zones. Detector zones must be planned so that the fire location is signalled quickly and clearly.

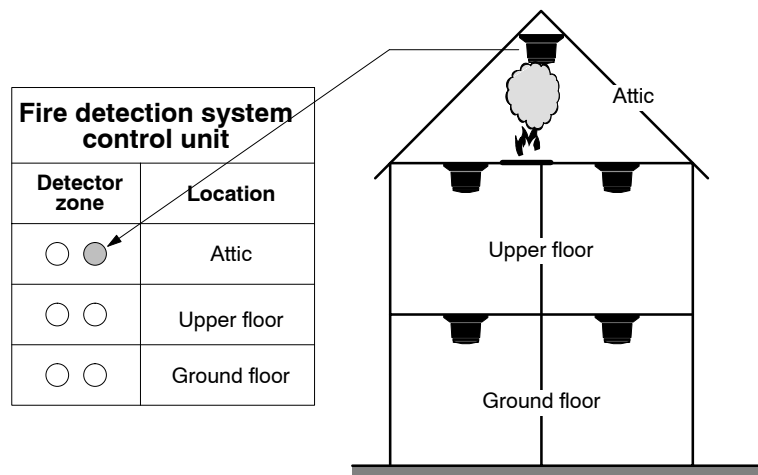
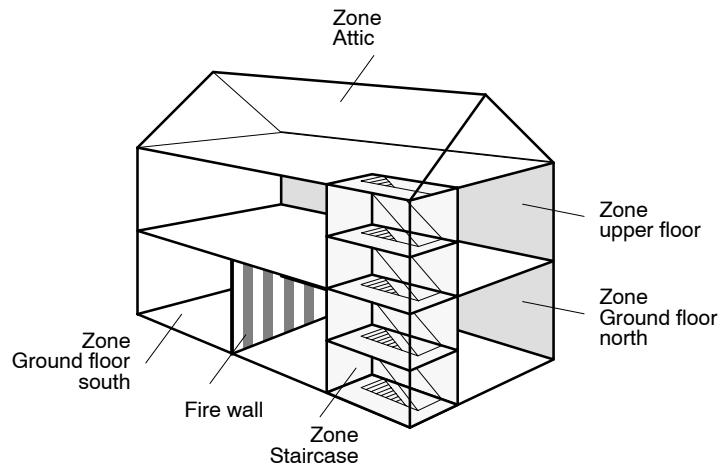

Fig. 108 Seat of fire location by forming detector zones

Detector zones must not extend beyond one floor and/or one fire compartment. Excluded from this rule are staircases, light, lift and installation shafts or tower structures and small multi-storey buildings which can be treated as separate detector zones.



*Fig. 109* Sub-division of the entire monitoring area into detector zones

A number of rooms should only be combined in one detector zone

- if the rooms are adjoining, if there are not more than five rooms

or

- if the rooms are adjoining, if their entrances are easy to supervise and if easily visible external response indicators are mounted in the vicinity of the entrances to signal a fire in the room concerned.

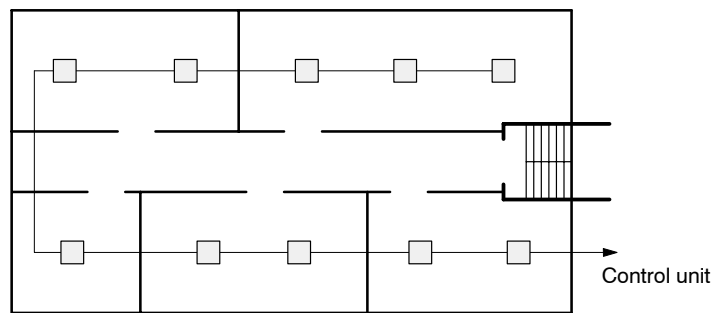

*Fig. 110* One detector zone for max. 5 adjacent rooms, external response indicator is unnecessary

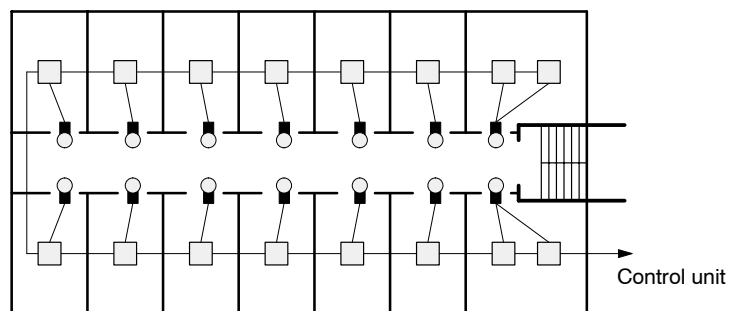

*Fig. 111* One detector zone for more than 5 adjacent rooms, external response indicator necessary

Normally flame detectors form detector zones of their own because these detectors often monitor large areas.

Detectors installed in raised floors, dropped ceilings, cable, air conditioning and ventilation systems, should form a special zone of their own, or it must be possible to determine in a simple way, e.g. using external response indicators, in which area detectors have responded.

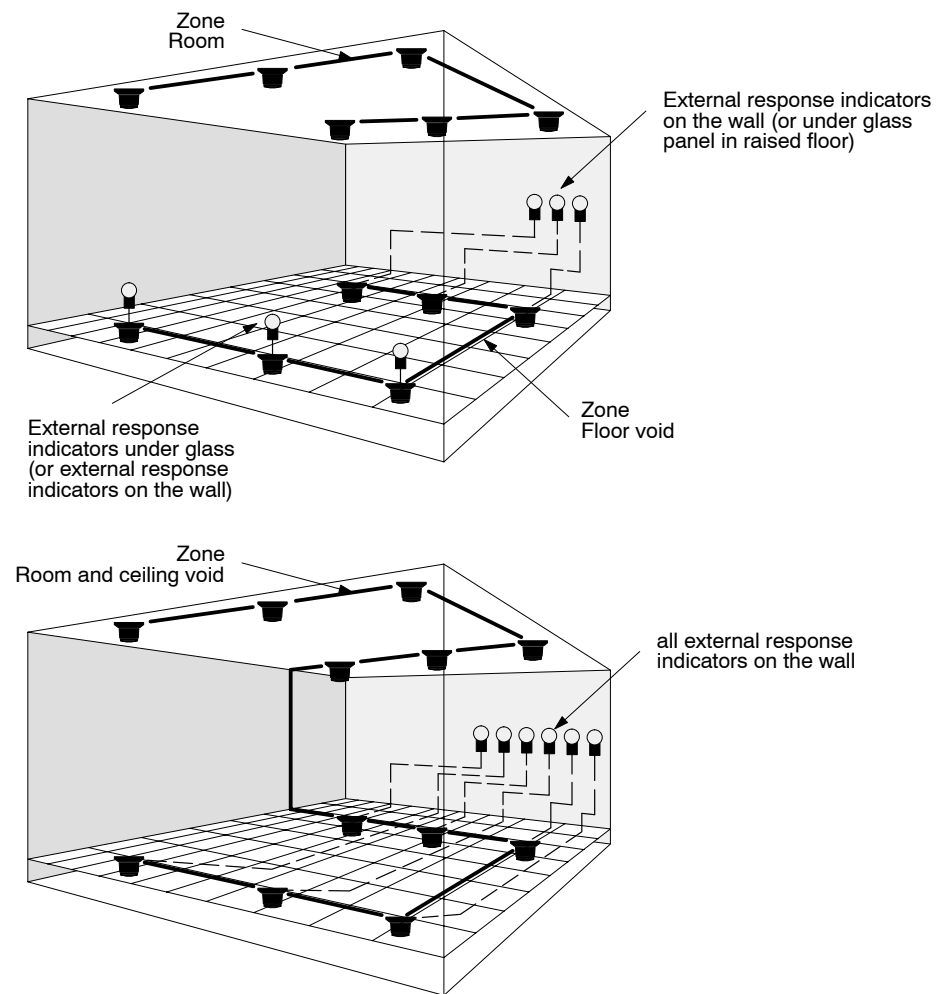

Fig. 112 Formation of detector zones in areas which are not immediately visible

## 6.2.2 Manual call points

The specific zone alarm signal is the initiating function at the control unit for the alarm organization sequence. For this reason separate zones must be created for manual call points.

Manual call points in staircases with more than 2 basement levels must always form separate zones working downwards from the ground floor or from the fire department entrance.

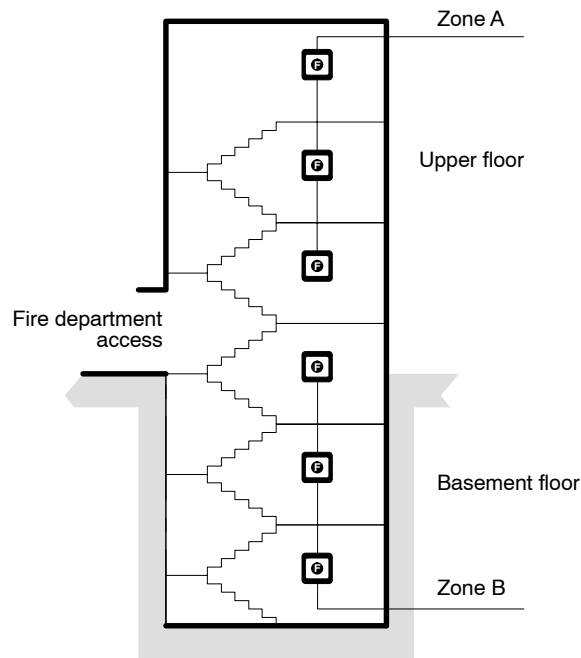

Fig. 113 Formation of zones of manual call points in staircases with more than two basement levels

### 6.2.3 Fire control installations

Frequently, in the event of fire, installations such as dampers, ventilation systems, lifts etc. have to be automatically activated. In order that this is possible from the zone control outputs at the control unit, the size of zone must be determined according to these conditions.

## 6.3 Maximum number of detectors per detector zone and detection line

**Note:** *Collective detection line MS9*  
*Addressable detection line MS9i*  
 See *Planning guidelines, document d804, Manual ZH4.1*  
*Planning Control unit for danger detection CZ10*

### 6.3.1 Restrictions on application

In order that a fire can be located quickly and clearly no more than 25 automatic detectors or 10 manual call points may be connected in one detector zone.

### 6.3.2 Maximum technical ratings

Fire detection system control unit line modules have varying technical specifications. The maximum permissible number of detectors per line module is technically restricted and varies according to the kind and model of the detector.

## 6.4 Temporary, local switching off of fire detectors

Fire detectors can be switched off by means of the time switch (AMT 12C) for between 18 minutes and 12 hours and automatically switched on again upon expiry of the selected switch-off period.

Within the same detector zone (MS7/MS9) any two detectors or several detectors in sequence can be switched off.

During the switch-off period fire alarm must still be guaranteed by

- manual call points in the zone concerned so that personnel **permanently** present can raise an alarm
- installing other, possibly less sensitive detectors (e.g. F detectors partially switched off, S- or D-type detectors continuously switched on).

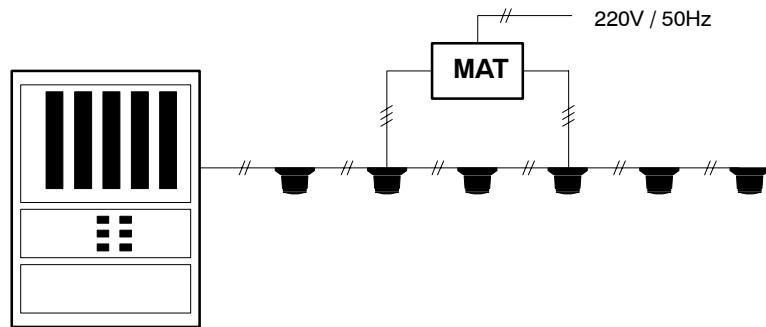

Fig. 114 Switching off of several detectors in sequence (MS7 or MS9)

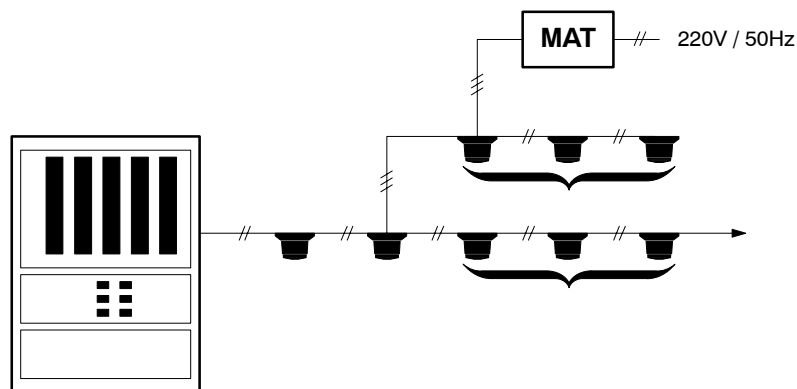

Fig. 115 Switching off of slave detectors with addressable detector system MS9i



# 7 Fire detection system control unit

## 7.1 Location of control unit

The control unit must be located according to the following criteria:

- In the immediate vicinity of the main entrance of the area to be monitored, or the entrance used by the fire department in an emergency. If this is not practical, then a display and operating terminal should be located here and connected to the control unit by a primary wire.
- Normal ambient conditions in respect of temperature, humidity, dust, vibration and mechanical damage.
- Easily accessible for servicing
- No solar radiation (avoid accumulation of heat)
- Location of the control unit in the area to be monitored and monitored by smoke detectors
- Trouble-free wiring (detector network, alarm, fire control installations etc.).

## 7.2 Remote display and operating terminal

With systems which cover a wide area it is practical to install display and operating terminals in different locations to save time in investigating alarm signals. According to the Cerberus alarm concept, alarm investigation including the resetting of an alarm, should not exceed ten minutes. In addition, no part of the area monitored should be more than 200m from a terminal.

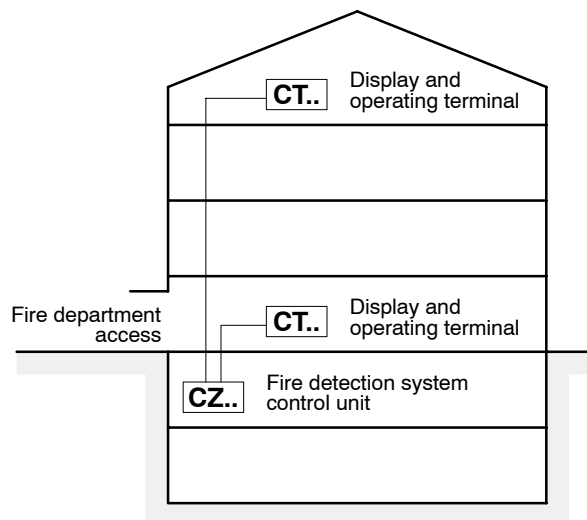

Fig. 116 Example of a fire detection system with remote display and operating terminal

### **7.3 Centralized or decentralized arrangement of the control unit in large fire detection systems**

Cerberus control units are designed for a certain maximum number of detector zones. Their specifications and configuration possibilities are laid down in separate planning documents (*Manual ZH4, CZ control units*).

If the fire detection system requires a larger number of detector zones or detection lines than permitted by the fire detection system specifications, one or more additional control units are required. In order to keep the line network to the fire detectors and control equipment as short and economic as possible, the additional control units are usually decentralized. They can function autonomously and can be combined with:

- display and operating terminals in one place
- or
- comprise with the DMS7000 integrated system.

### **7.4 Configuration of the Cerberus fire detection system control unit**

For planning information for the configuration of fire detection system control units see: *See Manual ZH4.1 for CZ10, ZH5 for CZ1.02 and CS11 for AlgoRex.*

# 8 Alarm

## 8.1 General

– Alarm must enable rapid intervention of fire-fighting forces. Basically the Cerberus alarm concept (CAC) should be used.

*See Planning guidelines, document e804, Manual ZH4.1 and document e1089, Manual CS11.*

# 9 Fire control installations

## 9.1 General

Installations which form part of the fire protection concept can be actuated automatically by the fire detection system.

This includes:

- the switching off of air conditioning or ventilation systems
- the closing of dampers
- the closing of fire doors
- the switching on of smoke and heat venting systems
- the switching on of emergency lighting
- the sending of lifts to the ground floor and blocking them there
- the switching off of machines and equipment of all kinds

The actuation of such installations must not have a negative influence on the fire detection system.

### 9.1.1 Actuation of fire control installations

The actuation of fire control installations depends on the prevailing conditions in the area being protected and must be specified in each case.

With smaller fire detection systems, normally all fire control installations are actuated in the event of an alarm.

With large fire detection systems fire control installations are linked to certain zones and actuated at alarm stage I or II.

Vital installations can be cross-zone actuated. Upon power failure all actuated installations must revert to their safe position, e.g.:

- Fire doors and dampers must close.

Fire control installation functions must be laid down in the system file.

### 9.1.2 Switching of external control

The control panel of the system concerned must indicate that actuation via the fire detection system has taken place.

Actuated installations must be brought back to their normal operating condition **independently** of the fire detection system.

**Example:**

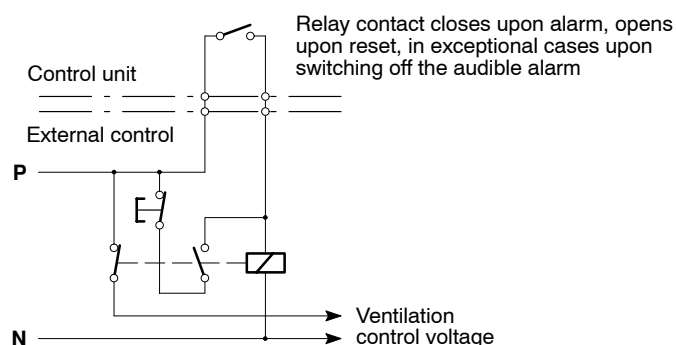

Fig. 117 Switching off ventilation

### 9.1.3 Control unit in TEST mode

If the control unit is in «TEST» mode, fire control installations may only be actuated if the fire detection system has to give a genuine alarm, e.g. when a manual call point is actuated.

### 9.1.4 Testing fire control installation actuation

It must be possible to test the correct functioning fire control installations without their being actuated.

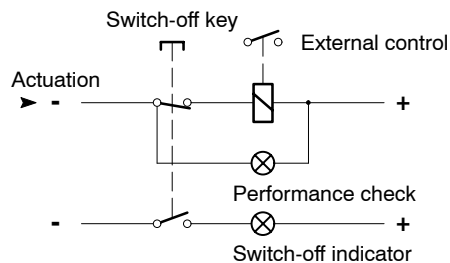

Fig. 118 Possibility of testing fire control installations

### 9.1.5 Safety precautions

Depending on the type of installation or device, actuation can have consequences which question the advantages of automatic actuation.

If in doubt choose manual instead of automatic actuation.

# 10 Avoiding deceptive alarms

## 10.1 General

Deceptive alarms can be largely avoided by choosing a suitable type of detector, response sensitivity, detector arrangement and by taking into account ambient conditions. The fire detection system's immunity to deceptive alarms is more important than high response sensitivity.

The following possibilities are just a few examples of how deceptive alarms can be avoided. Decide in each case on which measures are the most suitable.

## 10.2 Possible measures

### 10.2.1 Fire detectors

---

**General information: Set all automatic detectors or detector zones to alarm intermediate data storage.**

#### F-type detectors

**a)** In low rooms (room height  $\leq 3\text{m}$ ):

- use integrating detectors (blue marker) or switch detector zone to alarm intermediate data storage
- install detectors outside ceiling areas above permanent work places (e.g. near the door in small offices)
- set detectors to sensitivity level 1

**b)** In dusty and low rooms:

- use dust-resistant type of detector (e.g. F910 with small smoke entries or F930 with drift inquiry)
- shorter servicing interval (exchange of detectors)
- set detectors to sensitivity level 1

**c)** In rooms with transient deceptive phenomena caused by work processes:

- install detectors outside areas subject to deceptive phenomena
- use integrated detectors (blue marker) or switch detector zone to alarm intermediate data storage
- use detectors with adjustable smoke entries
- set detectors to sensitivity level 1

#### R-type detectors

As for F-type detectors, except:

- use F-type detectors or linear smoke detectors in dusty rooms.

### **D/T-type detectors**

Do not install detectors in places where, due to natural or operational sources of heat, the ambient temperature can cause the detector to respond.

- no direct solar radiation on the detector
- install at a distance from equipment which radiates heat such as baking ovens, hot air blowers, hot steam etc.
- protect detectors from warm air currents with metal screening

### **Rate-of-rise heat detectors**

- Replace the rate-of-rise heat detector by a maximum temperature detector if the above measures are not successful.

### **Flame detector S610 (single channel detector)**

- Keep detectors as far as possible from heat radiators
- the detector may only look towards the open air through glass, therefore, screw tight window to prevent it being opened
- do not expose detector to vibrations (oscillations) so that deceptive phenomena are not modulated
- reduce detector sensitivity, e.g. use stages 3, 2 or 1
- use flame detector S2406 (dual channel detector)

### **Flame detector S2406 (dual channel detector)**

- Keep detectors as far as possible from modulated heat radiators
- when used in open air the detector axis must not be pointed directly at the sun (observe sun's movement, it should shine from behind detector)
- do not expose detector to vibration (oscillations), so that deceptive phenomena are not modulated
- reduce detector sensitivity, e.g. use stages 3, 2 or 1
- if there are very hot and modulated heat radiators near where a detector must be installed, protect using the polyethylene foil provided.

## **10.2.2 Signal processing in the control unit**

### **Cerberus alarm concept (CAC)**

#### **Temporary alarm storage**

A temporary alarm storage (pulse register) in the control unit suppresses alarms, e.g. from brief electromagnetic influence, following repeated polling.

## **10.2.3 Measuring deceptive phenomena**

If the cause of an alarm is unclear likely deceptive phenomena must be measured with the appropriate measuring devices.

# 11 Procedure for planning a fire detection system

It is assumed that fire protection fire planning has been carried out according to Cerberus document 431 and that the fire detection system has to be planned as part of the all-round fire protection measures.

## 1 Compliance with local national guidelines and regulations

- Establish which regulations must be complied with. Such regulations take priority over Cerberus guidelines.

## 2 Specification of monitoring area

- Using plans, specify the area to be monitored.

## 3 Specification of sectors with fixed extinguishing systems

- Fire protection planning or the regulations will determine if an extinguishing system is required and if so what kind
- The extinguishing system must be planned according to separate guidelines.

## 4 Choice and arrangement of detectors

- Specify detectors on the basis of building or room utilization and the protection targets
- Specify the number of detectors required on the basis of the number of rooms and their geometry
- Make a detector specifications list.

## 5 Specify detector zones / detection lines

- Comply with technical and application limits
- Specify wiring for detector zones and detection lines.

## 6 Specify control unit location

- Specify any possible additional indicator and control terminals
- If several control units are required, check out the CS100 system.

## 7 Alarm

- Specify alarm concept (2-stage alarm/discreet alarm/possibly evacuation).

## 8 Fire control installations

- Specify which equipment is to be operated
- Set up a function plan
- Specify the locations of control elements with addressable systems and integrate them in detection line.

## 9 Prepare an installation block diagram

- Specify installation concept (with/without intermed. distrib.)
- Take into account max. permissible voltage drop
- Comply with local national regulations as regards type of cable, cross-sectional area, method of wiring etc.

## 10 Specification of the control unit

- Specify number and type of signal lines and extinguishing sectors
- Specify required emergency operating power period (battery)
- Take into account space available at control unit location
- Specify peripherals (printer etc.).

## 11 Calculation of equipment costs

- Make list of the equipment required with prices
- Possibly list in blocks for the purpose of the quotation
- Also list required test equipment and spares.

## 12 Calculation of installation costs (usually estimated poss. external)

- Wiring
- Installation and connection of detectors, alarm devices etc.
- Installation and connection of control unit, remote operation
- Commissioning and training
- Insert detectors and performance check.

## 13 Calculation of engineering costs (poss. incl. in equipment costs)

- Project planning
- Prepare the customer's technical documentation
- Prepare user data
- Co-ordination, visit site.

## 14 Prepare quotation

- (possibly fill out a tender instead of quotation)
- Prepare system description (concept)
- Prepare quotation (brief specification with price)
- Specify documents to be enclosed (system brochure, installation block diagram etc.).

## Explanation of abbreviations

<	smaller than	A	Total surface area to be monitored by detectors
>	greater than	A <sub>F</sub>	Size of fire (S detectors)
≤	smaller than or equal to	A <sub>IJ</sub>	Inter-joint area
≥	greater than or equal to	A <sub>M</sub>	Monitoring area per detector
a	Lateral distance (S detectors)	A <sub>Mk</sub>	Corrected (reduced) monitoring area per detector (monitoring area per detector, multiplied by correction factor K)
b	Full building width (gable width)	K	Correction factor for the reduction of the monitoring area per detector
d	Maximum detection distance (S detectors)	M	Number of detectors required
d'	Reference measurement for maximum detector spacing (s)	M <sub>m</sub>	Minimum number of detectors required
h	Height	M <sub>x</sub>	Number of detectors required in the ridge
h'	Partial height	M <sub>y</sub>	Number of detectors required on the slope of the ceiling
l	Length	N	Angle of inclination of ceiling
s	Maximum detector spacing		
s <sub>i</sub>	Increased maximum detector spacing		
x	Effective detector spacing parallel to ridge		
z	Reference measurement to determine the number of detector rows required for gable roofs		



# Keyword index

---

## C

Complete monitoring, 2

## D

Deceptive phenomena, 5

## E

Exchange of air, 28

Explanation of abbreviations, 92

## F

Fire control installations, 88

Fire load, 3

Fire phenomena, 21

Fire resistance, 4

Fire risk reduction, 4

Fire spread, 6

Fixed extinguishing system, 4

## O

Open incipient fire, 5

## P

Partial monitoring, 2

Planning symbols, 23

Point-type detector, 14

## S

Smoke distribution, 24, 25

Smouldering fire, 6

Smouldering incipient fire, 5

Sources of ignition, 3

Siemens Building Technologies AG  
Alte Landstrasse 411  
CH-8708 Männedorf  
Phone +41 1 - 922 61 11  
Fax +41 1 - 922 64 50  
[www.cerberus.ch](http://www.cerberus.ch)