

S

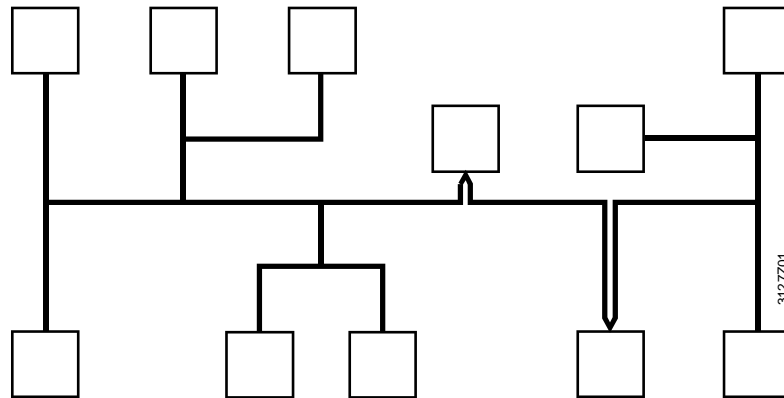

# Synco™ KNX bus communications

Device range Synco 700, Synco living,  
RXB/RXL, RDG, RDF, RDU  
Basic documentation



Siemens Switzerland Ltd.  
Sektor Infrastructure & Cities  
Building Technologies Division  
Gubelstrasse 22  
6301 Zug  
Switzerland  
Tel. +41 41-724 24 24  
<http://www.siemens.com/sbt>

© 2003-2013 Siemens Switzerland Ltd.  
Subject to change

# Contents

---

<b>1</b>	<b>KNX and Synco</b> .....	<b>5</b>
1.1	General overview.....	5
1.1.1	Definition of terms.....	6
1.2	Device range .....	8
1.2.1	Collective terms for the device types.....	9
1.2.2	Product markings on Synco bus devices.....	10
1.3	The KNX network.....	11
1.3.1	Full-scale KNX network.....	11
1.3.2	Network address.....	12
1.3.3	Device address.....	13
1.4	Area/line couplers and IP router .....	14
<b>2</b>	<b>Engineering notes</b> .....	<b>15</b>
2.1	Network design.....	15
2.1.1	Design engineering procedure .....	15
2.1.2	Number of bus devices per line, area and network .....	16
2.1.3	Bus load number E .....	17
2.2	Bus power supply .....	17
2.2.1	Distributed bus power .....	17
2.2.2	Power consumption of bus devices .....	19
2.2.3	Central bus power supply.....	20
2.3	Bus topologies.....	21
2.3.1	Distances and cable lengths .....	22
<b>3</b>	<b>Commissioning notes</b> .....	<b>25</b>
3.1	Points to check prior to commissioning.....	25
3.2	Commissioning with RMZ operator units .....	26
3.2.1	Start commissioning, plant mode "Off".....	26
3.2.2	Finish commissioning, plant mode "Auto".....	28
<b>4</b>	<b>Device address and device name</b> .....	<b>29</b>
4.1	RM... controllers.....	29
4.1.1	Read area, line and device address .....	29
4.1.2	Assign device names.....	30
4.2	Set device address with RMZ790 and RMZ791 operator units.....	32
<b>5</b>	<b>Device addresses via ACS</b> .....	<b>33</b>
5.1	Service tool OCI700.1 and ACS790 software .....	33
5.1.1	Overview .....	33
<b>6</b>	<b>Basic communication settings</b> .....	<b>35</b>
6.1	RM... controllers.....	35
6.1.1	Distributed bus power .....	35
6.1.2	Clock time operation .....	35
6.1.3	Set time slave remotely.....	36
6.1.4	Remote reset of fault.....	38
<b>7</b>	<b>Communication via zone addresses</b> .....	<b>39</b>
7.1	General notes on zones.....	39
7.1.1	Synco zoning.....	39
7.1.2	Communication of process values.....	40

7.1.3	Geographical zone (apartment).....	41
7.1.4	Default value "----" in series B devices .....	42
7.1.5	LTE reception and transmission zones .....	44
7.2	Address zones with RMZ operator units .....	46
7.2.1	RM... controllers.....	46
7.2.2	QAW740 room unit .....	46
<b>8</b>	<b>Large plants .....</b>	<b>47</b>
8.1	Engineering and commissioning .....	47
8.1.1	Network topologies .....	48
8.1.2	IP router as coupler to IP network .....	51
8.2	LTE filter table for couplers and IP routers.....	54
8.2.1	Filter settings .....	54
8.2.2	Predefined LTE filter table.....	55
8.2.3	Filtering, zone addresses, communication areas .....	56
8.2.4	LTE telegrams via couplers and IP routers .....	57
8.2.5	System time, alarms, and remote time adjustment .....	59
8.3	Engineering large plants .....	60
<b>9</b>	<b>Appendix.....</b>	<b>63</b>
9.1	Faults and errors.....	63
9.1.1	Fault status message bus .....	63
9.1.2	Communication error .....	64
9.2	Heating/cooling changeover.....	65
9.2.1	Changeover via digital input.....	66
9.2.2	Changeover via analog input.....	67
9.2.3	Changeover based on calendar .....	68
9.2.4	H/C changeover relay and fault status messages.....	69
9.3	Room control combination function .....	70
9.3.1	Application examples.....	70
9.4	Application with zones .....	74
9.4.1	Additional zones in the RXB/RXL room controller.....	75
9.5	Supply chains .....	76
9.5.1	Data exchange in LTE-Mode.....	78
9.6	Update process values .....	79
9.7	Lightning and overvoltage protection, EMC .....	80
9.7.1	Lightning protection .....	80
9.7.2	Overvoltage protection.....	83
9.7.3	Overvoltages in loops .....	84
9.7.4	EMC protection management.....	85
<b>Index</b>	<b>.....</b>	<b>86</b>

# 1 KNX and Synco

## 1.1 General overview

---

### About this document

This document contains:

- Section 1 Introductory information about Synco and the KNX network
- Section 2 Engineering notes
- Section 3 Commissioning notes
- Sections 4 to 7 Device address, device name and addressing via ACS, special features of KNX addressing and communication in LTE-Mode.
- Section 8 Designing "large plants"
- Section 9 Appendix with general, supplementary information

### KNX Association

The KNX Association is headquartered in Brussels and is an organization or association of manufacturers which maintains and further develops the KNX standard. The KNX Association supports the trend towards intelligent buildings, in which the various building services including lighting and security systems all communicate on the same network.

Aims and objectives of the KNX Association:

- Determine the range of functions for the devices installed in the network.
- Promote interaction between products from a wide range of manufacturers (interworking).
- Certify products that comply with KNX standards.
- Simplify commissioning of devices in KNX networks.
- Open the KNX bus to communications providers and utilities companies.
- Exploit various transfer media: Bus (TP1), wireless (RF) and power line (PL).

### KNX and Synco

The Synco devices are designed for HVAC applications and individual room control. They are used in:

- Residential buildings
- Business and administrative buildings
- Shopping malls and commercial buildings
- Schools and training centers
- Hotels and fitness, leisure and wellness centers

The KNX bus enables the Synco devices to communicate with each other, i.e. to exchange process values and system data in LTE-Mode. Typical values and data:

- Outside air temperature to devices in the same "outside air temperature zone" and room temperature to devices in the same "geographical zone" (multiple use of sensor values).
- Heating and refrigeration demand signals from zone controllers to the devices in the low-temperature hot water and chilled water generation partial plants.
- DHW priority signals (e.g. while charging the DHW tank).
- Time synchronization (the time master synchronizes the time slaves).
- Remote indication of fault and error messages (e.g. sensor error).

## 1.1.1 Definition of terms

---

### KNX bus

The KNX bus used with Synco is referred to as "KNX TP1". A full-scale KNX network is a three-level structure consisting of one area line, from which 15 main lines branch off. A further 15 lines can branch off from each main line. A network consisting of main lines and lines requires area and line couplers. If no area and line couplers are used, the network is restricted to one line.

### Bus topologies

Allowed bus topologies: Tree, line and star topologies. These topologies can be mixed as needed. However, ring topologies are not allowed. The tree topology has advantages over other topologies in cases where a large network has to be created (see "Bus topologies" in the KNX bus data sheet, N3127).

### Bus cable

The bus cable comprises two twisted conductors, CE+ (red) and CE- (black).

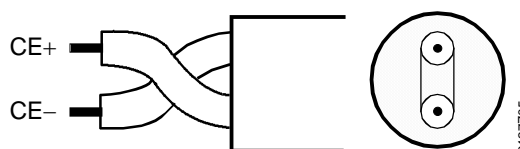

Unshielded bus cables are permitted for the KNX bus in conjunction with Synco devices. Shielded bus cables are recommended, however, if high interference is anticipated. For further details refer to data sheet N3127.

### Bus access method

The KNX bus uses CSMA/CA (CSMA = **C**arrier **S**ense **M**ultiple **A**ccess / CA = **C**ollision **A**voidance) to access the bus. With this method of access every bus user has equal data transmission rights. There is no communication master (in contrast to the master/slave principle). The data is exchanged directly (peer-to-peer) between bus users.

A collision avoidance strategy is required when several bus users attempt to send a message on the bus at the same time (multiple access). One bus user is given transmission priority, so that it can transmit its telegram fully and correctly. The other bus users stop transmitting and repeat their message after a given delay. The CSMA/CA method offers quick response times if the transmission capacity (number of connected bus users and process events) is utilized within the permitted limits.

### LTE-Mode

LTE-Mode (LTE = Logical Tag Extended) is characterized by the assignment of zone addresses (logical tags) to create communications bindings to exchange process values. Devices with the same zone address exchange process values with each other, one zone address being capable of transmitting the values of many data points.

Zone addresses                    The zones are addressed during local commissioning with the RMZ790 or RMZ701 operator units, or in the case of remote operation, with a PC/laptop and the ACS790 software.

**S-Mode**                            S-Mode is characterized by the assignment of (logical) group addresses to individual data points to create the communications bindings to exchange process values. Devices bearing the same group address exchange process values with each other.

Group addresses                The group addresses can be assigned to the group objects (S-Mode data points) with the **ETS** engineering and commissioning tool (**ETS** = Engineering Tool Software).

**Data points**                    For the various HVAC, lighting and security equipment and for integration into higher-level building automation and control systems, selected data points of the Synco devices can also communicate in S-Mode.

"Data points" are also referred to as "communication objects".

**Abbreviations**

	<b>Description</b>
<b>BK</b>	Area coupler (see Section 1.4).
<b>DPSU</b>	Decentral Power Supply Unit (see Section 2.2.1)
<b>E-Mode</b>	Easy-Mode, LTE-Mode is one of several Easy-Modes.
<b>ETS</b>	Engineering Tool Software.
<b>HVAC</b>	Heating, ventilating, air conditioning.
<b>IP</b>	<b>I</b> nternet <b>P</b> rotocol
<b>LK</b>	Line coupler (see Section 1.4).
<b>LTE-Mode</b>	Logical Tag Extended Mode, Easy Mode used by Synco.
<b>KNX</b>	Communications standard, wired TP1 (twisted pair).
<b>PSU</b>	Power Supply Unit (see Section 2.2.3).
<b>S-mode.</b>	System mode, configuration/commissioning with ETS only.
<b>TP1</b>	<b>T</b> wisted <b>P</b> air <b>1</b> , data transfer medium: Bus

## 1.2 Device range

### Introduction

The table below lists the devices in the Synco 700, Synco living, RXB/RXL, and RDG/RDF/RDU ranges which have a TP1 (wired) KNX interface. These devices have a network address and can communicate via the KNX bus in LTE-Mode.

### Note

The table does **not** list all devices of the range (e.g. Synco 700 extension modules RMZ78x are not listed).

Devices	Types	Data sheet
Synco 700	<b>Universal controllers</b> For use in ventilation, air conditioning and chilled water systems as well as for primary plant with individual room control.	<b>RMU710B</b> <b>RMU720B</b> <b>RMU730B</b> <b>N3150</b>
	<b>Heating controllers</b> For boiler and heating circuit controls, primary controllers, and district heating plants.	<b>RMH760B</b> <b>N3133</b>
	<b>Boiler sequence controller</b> For multiple boiler systems with up to 6 boilers.	<b>RMK770</b> <b>N3132</b>
	<b>Central control unit</b> For individual room control with RXB/RXL room controllers.	<b>RMB795B</b> <b>N3122</b>
	<b>Switching and monitoring device</b> For HVAC and chilled water applications.	<b>RMS705B</b> <b>N3124</b>
	<b>Bus operator unit</b> Access via KNX to Synco 700 devices and RXB/RXL room controllers.	<b>RMZ792</b> <b>N3113</b>
	<b>Room unit</b> With setpoint adjustment, mode and timer buttons.	<b>QAW740</b> <b>N1633</b>
	<b>Central communication units</b> For remote operation and monitoring of Synco devices in KNX networks Central communication unit for up to 4, 10 or 64 Synco devices Central communication unit for up to 250 Synco devices.	<b>OZW771</b> <b>OZW772</b> <b>N3117</b> <b>N5701</b>
Synco living	<b>Central apartment unit</b> To manage one apartment. Heating/cooling/ventilation, control of lighting and blinds, door and window monitoring.	<b>QAX903</b> <b>QAX913</b> <b>N2741</b> <b>N2740</b>
Synco RXB/RXL	<b>Room controllers</b> For fan-coil units with 3-speed fan control For fan-coil units with 3-speed fan control and electric heating coil For fan-coil units with 3-speed fan control For fan-coil units with 3-speed fan control and electric heating coil For fan-coil units with 3 analog outputs, DC 0...10 V For fan-coil units with 3 analog outputs, DC 0...10 V For chilled ceilings and radiators For chilled ceilings and radiators	<b>RXB21.1</b> <b>RXB22.1</b> <b>RXL21.1</b> <b>RXL22.1</b> <b>RXB39.1</b> <b>RXL39.1</b> <b>RXB24.1</b> <b>RXL24.1</b> <b>N3873</b> <b>N3877</b> <b>N3875</b> <b>N3876</b> <b>N3874</b> <b>N3878</b>
Synco RDG/RDF/RDU	<b>Communicating room thermostats</b> Fan coils, semi-flush mount Variable air volume, semi-flush mount Fan coils, wall mount Variable air volume, wall mount	<b>RDF...KNX</b> <b>RDU341</b> <b>RDG1..KN</b> <b>RDG400KN</b> <b>N3171</b> <b>N3172</b> <b>3191</b> <b>3192</b>
Service tool	<b>ACS790 software and service-interface</b> For Synco device commissioning and diagnostics.	<b>OCI700.1</b> <b>N5655</b>

### RMZ790 and RMZ791 operator units

In small plants in particular, the RMZ790/RMZ791 operator units (no bus devices) allow for commissioning of Synco 700 RM... controllers (e.g. set device address, see Section 4.2).

<b>Operator units</b> Plug-in unit for Synco 700 controllers Also suitable for mounting away from controller, e.g. on control panel door.	<b>RMZ790</b> <b>RMZ791</b>	<b>N3111</b> <b>N3112</b>
---	--------------------------------	------------------------------

### Synco 100, Synco 200

The devices in the Synco 100 and Synco 200 ranges are non-communicating and are not dealt with in this document.



## 1.2.1 Collective terms for the device types

---

In this document, the devices on in the table on the previous page may be referred to collectively as follows.

Synco 700 RM...controllers	<p>The term "Synco 700 RM... controllers", or "RM... controllers" for short, refers to the following device types:</p> <ul style="list-style-type: none"><li>• Universal controllers RMU710B, RMU720B, RMU730B</li><li>• Heating controllers RMH760B</li><li>• Boiler sequence controllers RMK770</li><li>• Central control units RMB795B</li><li>• Switching and monitoring device RMS705B</li></ul>
RXB/RXL room controllers	<p>The term "RXB/RXL room controllers" or "RX... room controllers" refers collectively to the following device types:</p> <ul style="list-style-type: none"><li>• Room controllers RXB21.1, RXB22.1</li><li>• Room controllers RXL21.1, RXL22.1</li><li>• Room controllers RXB39.1, RXL39.1</li></ul>
Room thermostats RD...	<p>The term "Room thermostats RDx..." refers collectively to the following types:</p> <ul style="list-style-type: none"><li>• Room thermostats RDG100KN, RDG400KN</li><li>• Room thermostats RDF301, RDF301.50</li><li>• Room thermostat RDU341</li></ul>
Central communication units OZW77x	<p>The term "Central communication unit OZW77x" refers collectively to the following types:</p> <ul style="list-style-type: none"><li>• Central communication units OZW771.xx (where xx = 4, 10, 64)</li><li>• Web server OZW772.xx (where xx = 1, 4, 16, 250)</li></ul>
Synco bus devices	<p>The term "Synco bus devices" refers collectively to the following types:</p> <ul style="list-style-type: none"><li>• Synco 700 controllers RM...</li><li>• Room controllers RX...</li><li>• Room unit QAW740</li><li>• Bus operator unit RMZ792</li><li>• Central communication units OZW77x</li><li>• Synco living central apartment unit QAX9x3</li></ul>
Bus devices	<p>"Bus devices" include the Synco bus devices (see above) and devices from third-party manufacturers. Bus units use a KNX network address.</p>

## 1.2.2 Product markings on Synco bus devices

---

The Synco bus devices are labeled with product markings with the following meanings:



KNX Logo

Devices with this logo are certified by KNX.



KNX transmission medium

TP1 stands for: **T**wisted **P**air **1** (1 pair of twisted wires).



KNX configuration mode

EE stands for **E**asy (mode), Logical Tag **E**xtended.

# 1.3 The KNX network

## 1.3.1 Full-scale KNX network

### KNX network, three-level structure

A full KNX network is structured on three levels. It consists of:

- Backbone (area line) 0 → Area 0 (backbone)
- Main lines 1...15 → Areas 1...15
- Lines 1.1...15.15

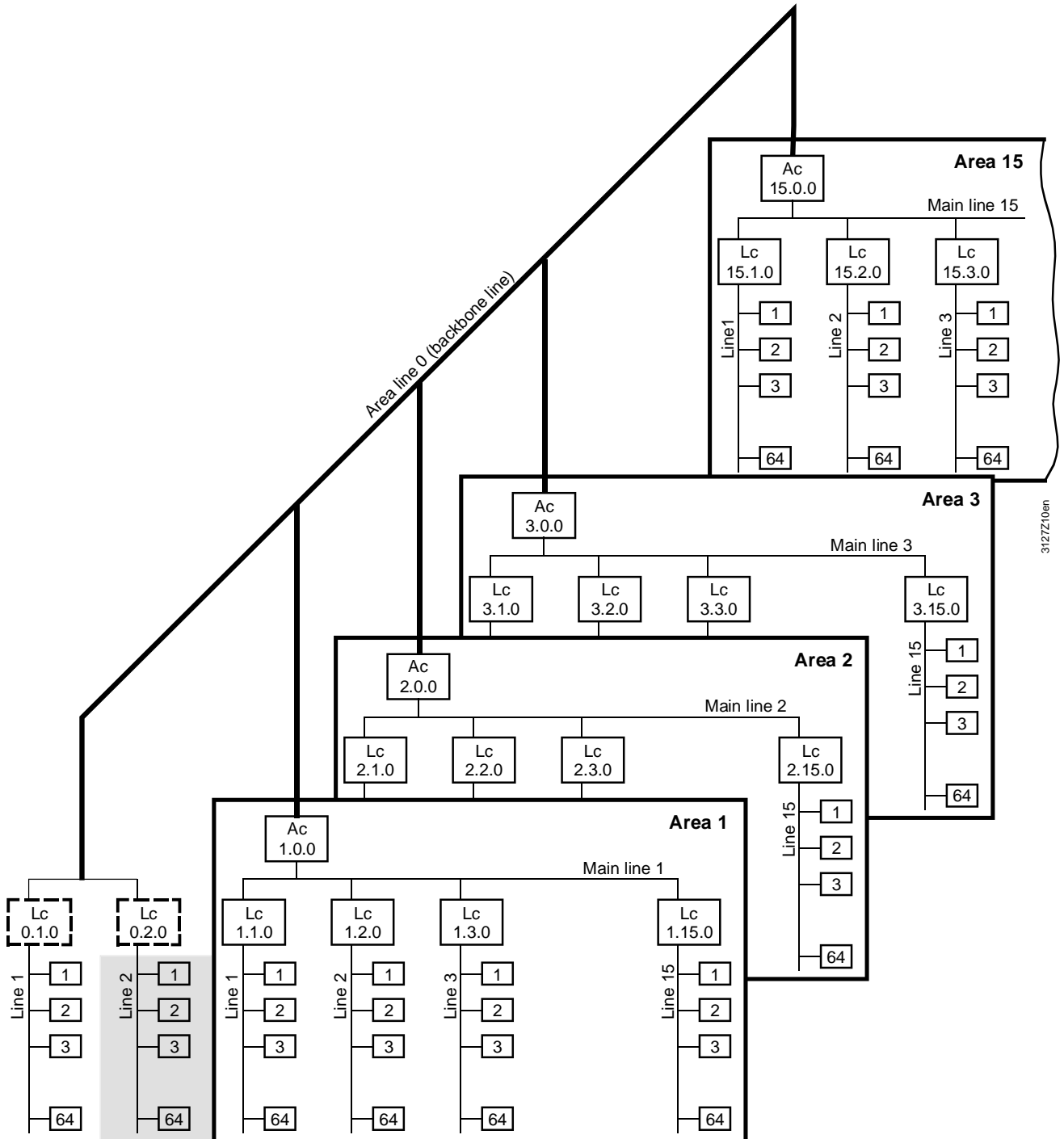

### Note

The arrangement of the bus devices in the 3-level KNX network structure, with the Synco bus devices factory set with Area/Line address 0.2 corresponds to the gray shaded area in the illustration above.

<b>Area line 0</b>	The area line is the backbone of the network. The subnetwork address (area line) is 0.0 (zero.zero). 15 area couplers (Ac) can be connected to the area line, in addition to bus devices (not shown), whose number is determined by subtracting the number of area couplers from 64.
<b>Main lines</b>	15 main lines can branch off from area line 0 by means of area couplers. The area couplers used to establish the main lines have physical addresses from 1.0.0 to 15.0.0. Each main line can accommodate 15 line couplers (Lc), in addition to bus devices (not shown) whose number is determined by subtracting the number of line couplers from 64.
<b>Lines</b>	15 lines can branch off from each main line via line coupler. The line couplers used to establish the lines from main line 1 have physical addresses from 1.1.0 to 1.15.0. Line couplers from main line 15 have physical addresses from 15.1.0 to 15.15.0.

### 1.3.2 Network address

---

**Network address** The network address for a full-scale KNX network consists of the area, line and device address. It reflects the exact position of a bus device in the overall network and is unique within the network.

Syntax of the network address

**Syntax:** Area.Line.Device

Range	0	Ex works for Synco bus devices = 0 (backbone)
Range	1...15	
Line.	1...15	Ex works for Synco bus devices = 2
Device	1...255	Ex works for Synco bus devices = 255 Excepting OZW775 central communication unit = 150

**Area and line address** The Synco bus devices are factory-set with the KNX-defined area and line address 0.2.

**Individual address** The "individual address" (a term from the KNX world) consists of the address components area, line and device, and corresponds to the network address already defined.

**Physical address** The "physical address" is another term for "individual address".

**Subnetwork, Subnetwork address** In KNX terms, a subnetwork is the same as a line. Hence, the subnetwork address consists of the address components "area" and "line".

### 1.3.3 Device address

#### Device identification

As described above, the network address consists of a combination of the area, line and device address, for example 0.2.10, where 0 stands for the area, 2 for the line and 10 for the device address.

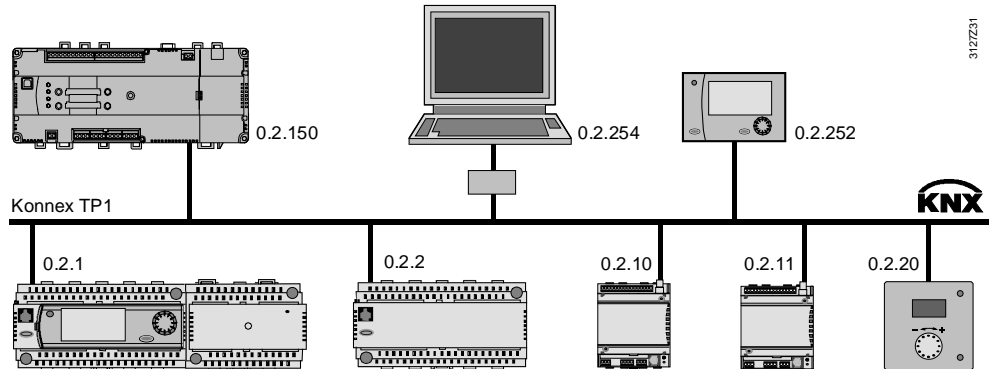

#### Device addressing

Device addressing must be planned at the design engineering stage. Note the following points when assigning addresses:

- Each device address may be allocated only once within an area and a line.

Device addresses in the range 1 to 251 must be used for the maximum 64 bus devices on a line (the same applies on a main line). Addresses 0, 150, 252, 254 and 255 are reserved for the following:

- 0 is used in each area or each line for the area or line coupler respectively.
- 150 is the factory-set device address for the OZW772 web server (device address 150 can be modified).
- 252 is used to connect the RMZ792 bus operator unit, i.e. the bus operator unit uses this address if it is free; otherwise it starts at 252 and looks for the next lower unused address.
- 254 is used to connect the ACS790 software on PC/laptop, i.e. the OCI700.1 service tool adopts this address if free, or starts at 254 and looks for the next lower unused address.
- 255 is the factory-set device address of the Synco bus devices (see the notes below).

#### Notes

The factory-set address 255 in the Synco bus devices prevents communication problems in the commissioning phase. This is because devices with this address do not send any data. However, they can be controlled manually, and can receive the new device address setting, for example.

The device addresses of the Synco 700 RM... controllers can be set with the RMZ790 and RMZ791 operator units (see Section 4.2) or with the ACS790 software.

Remember not to use device addresses 150, 252 and 254 when addressing the bus devices.

## 1.4 Area/line couplers and IP router

---

### Use of couplers

Complex networks covering large areas may require area and line couplers for two main reasons.

- When the KNX network comprises more than 64 bus devices.
- When the network would exceed the permissible limits without couplers.

A network which uses area and line couplers makes it possible to create "communication islands" with the aim of restricting data traffic across areas or lines to a minimum. The couplers link the "communication islands" on the basis of the network layer (the router function of Layer 3 of the OSI reference model).

### Siemens area/line coupler

The recommended area/line couplers are supplied by Siemens, order numbers:

- 5WG1 140-1ABx3, short code N140/x3  
bus connected to main line and line via bus terminals.

For further information see the product description and description of functions (enclosed with the device) or under:

### Use of IP routers

IP<sup>1)</sup> routers are required when a KNX network needs to be connected to an IP network.

As a device, the IP router is not technically the same as the area/line couplers. Instead of establishing a link within KNX, a "KNX-IP network" link is created, whereby the IP router connects a KNX area or a KNX line to an IP network.

<sup>1)</sup> IP = Internet Protocol: Network protocol for data traffic, routing and, in the case of internetworking, for global, addressing.

### Siemens IP router

The recommended IP router is supplied by Siemens, order no.:

- 5WG1 146-1AB01, short code N146  
Bus connected via bus terminals, IP network connected via RJ45 socket

For further information see the product description and description of functions (enclosed with the device) or under: <http://www.siemens.com/knx-td>

## 2 Engineering notes

### 2.1 Network design

#### 2.1.1 Design engineering procedure

For engineering see also the information in data sheet N3127.

#### Design engineering flow chart

Project data

Devices, bus devices

Network

Step	Activity	Objective
1	Assess the situation.	<ul style="list-style-type: none"><li>• Accurate plan of plant with location of buildings and room layout.</li><li>• Overview of hydraulic system.</li></ul>
2	Draft proposed solutions and establish how to implement them.	<ul style="list-style-type: none"><li>• Clear project definition.</li></ul>
3	Include plans for possible expansion zones for extensions.	<ul style="list-style-type: none"><li>• Advance planning of the scope to expand the plant.</li></ul>
4	Determine device types and quantity.	<ul style="list-style-type: none"><li>• Table of device types.</li><li>• Number of devices per line and area, within the permitted limits.</li></ul>
5	Define the installation of the devices in accordance with technical functions.	<ul style="list-style-type: none"><li>• Entry on plant diagram.</li><li>• List of applications.</li></ul>
6	Define cable routing and cable lengths.	<ul style="list-style-type: none"><li>• Entry on plant diagram.</li><li>• Network size within allowed limits.</li></ul>
7	Determine type of bus power supply.	<ul style="list-style-type: none"><li>• Distributed bus power.</li><li>• Central bus power supply.</li></ul>
8	Check limits.	<ul style="list-style-type: none"><li>• Number of bus devices per line and area.</li><li>• Size of network.</li><li>• Adequate bus power (with reserve for later expansion).</li></ul>
9	Create network structure and wiring diagram.	<ul style="list-style-type: none"><li>• Complete installation and commissioning documents.</li></ul>

#### Special criteria

When structuring a network, special attention should be paid to certain criteria:

- The number of bus devices in a line, in an area and in the network.
- The type of bus power supply in relation to the number and properties of the bus devices.
- The total length of all the bus cables in one line and in the network.
- The distances between the bus devices.
- The distance between the bus devices and the nearest bus power supply.

Large plants

See the special notes in Section 8 on design engineering for "large plants".

Lightning and overvoltage protection, and EMC

Note special criteria in relation to lightning and overvoltage protection and EMC. For details see the discussion in Section 9.7.

## 2.1.2 Number of bus devices per line, area and network

---

### 64 bus devices on one line

Up to 64 bus devices can be installed on one line (including a main line and area line 0). There are no restrictions relating to the type mix.

#### Notes

The Synco 700 type RMZ78x expansion modules, the RMZ790 and RMZ791 operator units and the room units connected (via PPS2) to the RXB/RXL room controllers do not have a KNX interface and can be omitted from the design total. In installations incorporating Synco bus devices (plus the OCI700.1 service tool, if connected) and third-party devices, the number of Synco bus devices is reduced in accordance with the number of third-party devices.

### 960 bus devices in one area

Based on 64 bus devices per line and 15 lines per area, up to 960 bus devices can be installed in an area. The network addresses for Area 1 are:

- Area couplers 1.0.0
- Line couplers 1.1.0...1.15.0
- Bus devices 1.1.1...1.15.254

#### Note

With KNX TP1 only 64 bus devices are permitted in device address range 1...254.

### 16,320 bus devices in a network

Theoretically, a total of 16,320 bus devices could be installed in a full KNX TP1 (wired) network. In practice the number is approximately 12,000 bus devices.

Based on 960 bus devices per area, and a full-scale network comprising 15 areas, up to 14,400 bus devices can be installed in one network.

#### Main lines 1...15

64 bus devices can be connected to each of the 15 main lines, giving a further 960 bus devices in addition to the 14,400 calculated above, which makes a total of 15,360 bus devices.

#### Area line 0

Another 64 bus devices can be installed in each of the 15 lines branching off from area line 0, now giving a total of 15,260 bus devices. Normally, however, no line couplers are installed in area line 0.

#### Notional Line 2

Note: The preset addresses, area address 0 and line address 2 relate to a "fictitious line 2" branching from area line 0. The network addresses for this line are 0.2.1 to 0.2.254.

The term "fictitious line 2" indicates that there is no need to install a line coupler 0.2.0. See the illustration in Section 1.3, Full-scale KNX network



## 2.1.3 Bus load number E

---

### Device data traffic

Bus load E, or E-characteristic, applies to the average data traffic of a device on the bus.

The E-characteristic does not have to be calculated for a line containing the allowed 64 bus devices (because the total E-characteristic is less than 300). Bus load characteristic E of a device is indicated in the related data sheet.

## 2.2 Bus power supply

### 2.2.1 Distributed bus power

---

#### Introduction

A bus power supply is always required for bus communications. There are two options:

- Distributed bus power      DPSU      = Decentral Power Supply Unit
- Central bus power supply    PSU      = Power Supply Unit

#### Note

In any one line (including a main line) either the DPSU or PSU may be used.

#### Devices with a bus power supply

The following devices are delivered factory-set with the bus power supply enabled, and supply power to the bus.

- Synco 700 RM...controllers DC 29 V, 25 mA
- QAX9x3 central apartment unit      See the caution notice below .

#### Notes

Since the devices which are factory-set to "Decentral bus power supply = On" are distributed on the bus, they are referred to as "Distributed bus power supply units" (DPSU).

Devices with the setting "Decentral bus power supply = On" must not be installed on the same line as third-party devices. In such cases, the devices must be set to "Decentral bus supply = Off" and a power supply unit must be installed (see next section "Central bus power supply").

In devices with a bus power supply, the bus power section is electrically isolated from the KNX bus.

#### Caution!

In addition to its own intrinsic consumption, the QAX9x3 central apartment unit when set to "Bus power = On" delivers the bus power supply for one OZW771 central communication unit or OZW772 web server, or for the OCI700 service interface.

If other devices are installed on the same line, the central apartment unit must be set to "Bus power supply = Off". In this case, the bus power must be supplied by setting other devices such as the RM... controllers to "Decentral bus power supply = Off", or by installing a power supply unit.

<b>Devices without a bus power supply</b>	<p>Devices without a bus power supply</p> <ul style="list-style-type: none"> <li>• QAWZ40 room unit</li> <li>• RXB/RXL room controllers</li> <li>• Room thermostats RDG/RDF/RDU</li> <li>• RMZ792 bus operator unit</li> <li>• OZW771.xx central communication units</li> <li>• OZW772.xx web server</li> <li>• OCI700 service interface</li> <li>• Area/line couplers and IP router</li> </ul>
Note	<p>Devices without a bus power supply require devices on the same line with a DPSU or a power supply unit, PSU.</p>
<b>Rule of thumb</b>	<p>The rule is: <u>One</u> device with a DPSU can operate <u>two</u> devices without a bus power supply plus the OCI700 service interface plus the OZW771 central communication unit.</p> <p>Per line, the rule is:</p> <p>1 device with a DPSU + 2 devices with no bus power supply + OCI700 + OZW771  <b>up to a maximum of</b>  8 devices with a DPSU + 16 devices with no bus power + OCI700 + OZW771.</p>
Optimization	<p>An RM... controller with a DPSU delivers a net current of 25 mA. This covers the power consumption of 5 devices without a bus power supply (5mA each required).</p> <p>8 devices with a DPSU on one line deliver 200mA. This covers the power consumption for 40 devices or 38 devices plus OCI700 plus U/W771.</p>
Notes	<p>Even with devices having a low current requirement (&lt; 3 mA), the number of devices in a line must not exceed 64.</p> <p>See the data sheets for the power consumption of the new Synco devices.</p>

## 2.2.2 Power consumption of bus devices

---

To make the best use of the connectable devices set to "Decentral bus power supply = Off" and the devices without a bus power supply, it is necessary to calculate the current requirement from the KNX bus.

Power consumption for Synco devices with "Bus power supply unit = Off".

- RMU7x0, RMU7x0B universal controllers 5 mA
- RMH760, RMH760B heating controllers 5 mA
- RMK770 boiler sequence controller 5 mA
- RMB795, RMB795B central control units 5 mA
- RMS705, RMS705B switching & monitoring devices 5 mA
- OZW775 central communication unit 5 mA
- QAX9x3 central apartment unit 5 mA

Power consumption values for Synco devices without a bus power supply unit:

- QAWZ40 room unit 7.5 mA
- RXB/RXL room controllers 5 mA
- RMZ792 bus operator unit  
without external supply 45 mA  
with external AC 24 V supply 5 mA
- OZW771.xx central communication units 5 mA
- OZW772.xx web server 5 mA
- VAV controller GxB181.1E/KN 5 mA
- Room thermostats RDF, RDG, RDU 20 mA
- Room thermostat RDF600KN 5 mA
- Flush-mounted sensor AQR2570 5 mA
- Flush-mounted sensor AQR2576 15 mA
- Room units QMX3.P02, 30, 34 7.5 mA
- Room units QMX3.P37 10 mA
- Room units QMX3.70, 74 15 mA

Power consumption values for service interface, coupler and IP router:

- OCI700 service interface 5 mA
- Area/line coupler N140/x13  
Primary line (main line) 6 mA  
Secondary line (sub-line) 8 mA
- IP router N146 from bus <sup>1)</sup> 10 mA

<sup>1)</sup> The Siemens IP router N146 consumes 10 mA from the KNX bus despite the additional external auxiliary voltage AC/DC 24 V. Power consumption with auxiliary voltage: 25 mA at DC 24 V, max. 800 mW.

## 2.2.3 Central bus power supply

---

### Introduction

When one or more power supply units (PSU) are used for the bus power supply, this is referred to as a "central bus power supply". This type of bus power supply is required in the following circumstances:

- The max. allowed 8 Synco devices with DPSU (Decentral bus power supply = On") is insufficient to cover the power consumption of the devices without a bus power supply.
- Synco devices and third-party devices are installed on the same line.
- Only devices without a bus are installed on the same line.

### Note

On a line with a central bus power supply, the following devices must not be used to supply power to the bus:

- RM... controllers
- OZW775 central communication unit
- QAX9x3 central apartment unit

These Synco devices must be set to "Decentral bus power supply = Off" to prevent them from interfering with bus communications.

### Power supply unit PSU

At present, power supply units for **160**, **320** und **640 mA** are available. The power requirements of the devices must be calculated as a means of determining the required power supply unit, PSU See the relevant values on the previous page.

For a line with 64 bus devices, each with a power consumption of 5 mA (64 x 5 mA = 320 mA), a PSU of 320 mA is sufficient.

### Siemens power supply units

For KNX networks, the following PSUs by Siemens are recommended.

Order types:

- 5WG1 125-1AB02, short code N125/02                      160 mA (with integrated choke)
- 5WG1 125-1AB12, short code N125/12                      320 mA (with integrated choke)

Product data:

- Operating voltage AC 120...230 V, 50...60 Hz
- Bus voltage output                      DC 29 V (21...30 V, with choke)

For KNX networks with IP routers, the following Siemens power supply unit is recommended:

Order type:

- 5WG1 125-1AB22, short code N125/22                      640 mA

Product data:

- Operating voltage                      AC 120...230 V, 50...60 Hz
- Bus voltage output                      DC 29 V (21...30 V, with choke)
- Auxiliary voltage output for IP router      DC 24 V (12...30 V, without choke)

For further information see the product description and description of functions (enclosed with the device) or under: <http://www.siemens.com/knx-td>

### Note

A DC 29 V voltage with choke is required for the bus power supply. The DC 24 V auxiliary voltage for the IP router requires a voltage source without choke.

## 2.3 Bus topologies

Advantage:  
Tree topology

Allowed bus topologies: Tree, line and star topologies. These topologies can be mixed as needed. However, ring topologies are not allowed.

The tree topology is advantageous if a large network must be created.

**Tree topology** (with stub lines)

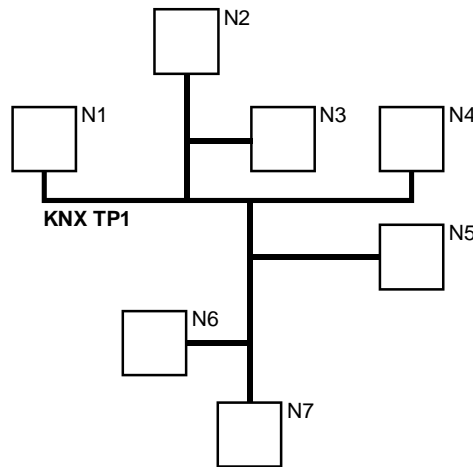

N1 .. N7 Bus devices

**Line topology** (with loops)

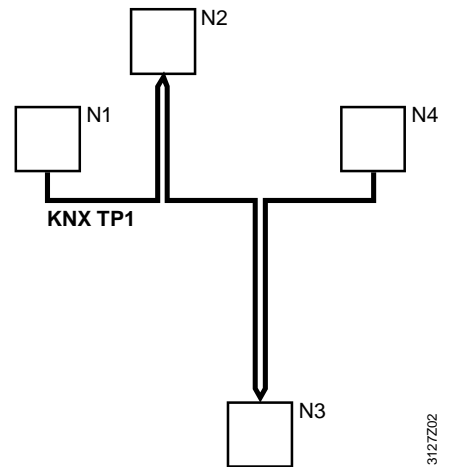

3127202

### Branching and connection variants

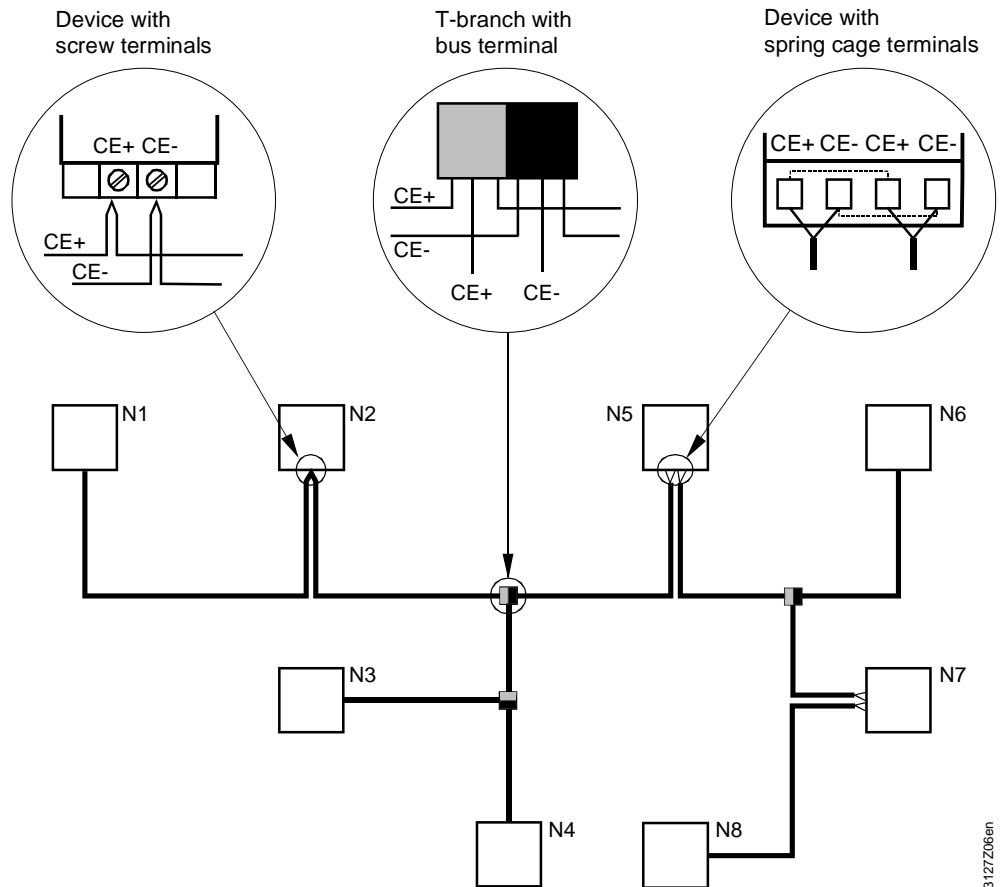

N1 .. N8 Bus devices

3127206en

## 2.3.1 Distances and cable lengths

Bus cable: KNX specified

The details of distances and cable lengths in a network are designed for bus cables specified by KNX.

### Network with DPSU

In a KNX network with a "decentral bus power supply unit, DPSU" (see Section 2.2.1), the distances between devices depend on the number of devices with a DPSU.

Number of devices with DPSU	Maximum distance		Total length of all cables on one line
	From device with DPSU to bus device	From bus device to bus device	
1	350 m	350 m	max. 350 m
2	350 m	700 m	max. 700 m
3 to 8	350 m	700 m	max. 1000 m

There is no minimum distance between devices with a DPSU.

<sup>1)</sup> Bus device without bus power supply unit

### Network with PSU

In a KNX network with "central bus power, PSU" (see Section 2.2.2), note the following information on distances:

- Distance between two power supply units, PSU Min. 200 m
- Distance between bus device and nearest PSU Max. 350 m
- Distance between bus devices Max. 700 m
- Total length of all cables of one line Max. 1000 m

### Notes

At least one power supply unit, PSU, is required for each line, and the maximum per line is two.

The power supply unit should be installed as close to the middle of a line as possible so that the maximum line length is possible.

The distance between a bus device and the nearest power supply unit must not exceed 350 meters. Thus:

- Even if the power consumption of the bus devices does not demand it, two power supply units may be required, depending on the length of a line, or a network with several lines and power supply units must be created.

### Example 1

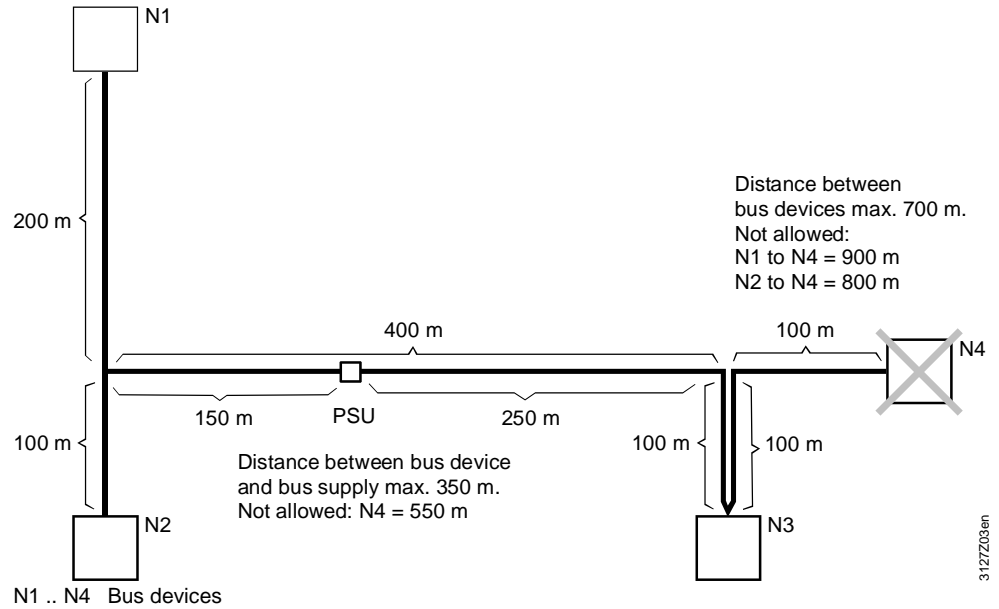

### Distances

Bus device N4, by adhering to the max. allowed distance of 700 m between bus devices, cannot be integrated in the bus if bus device N3 is integrated with a loop (instead of subline).

If a max. distance of 350 m is kept between the centralized bus supply PSU and the bus device (without bus supply), the bus supply must be placed at location 150 m / 250 m on the line distance 400 m.

### Example 2

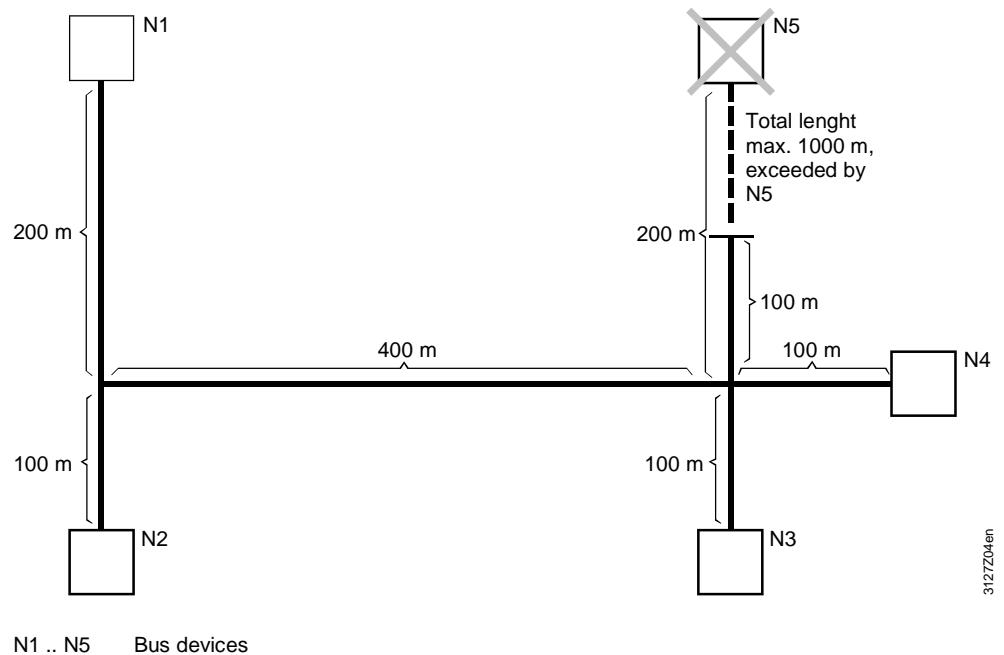

### Total length

The allowed total length of 1000 m in the line is exceeded, if device N5 is integrated in the bus at the given bus wiring.

Empty page



## 3 Commissioning notes

### 3.1 Points to check prior to commissioning

---

<b>General points to check</b>	<p>The following points must be checked before commissioning starts.</p> <ul style="list-style-type: none"><li>• Check that bus devices and field devices are installed.</li><li>• Check the wiring against the plant wiring diagram.</li><li>• Check that all devices have an operating voltage:<ul style="list-style-type: none"><li>AC 24 V Synco 700 RM... controllers, RXL room controllers, OZW775 central communication unit. The RMZ792 bus operator unit can be operated with AC 24 V or powered via the KNX bus.</li><li>AC 230 V RXB room controllers, OZW771 central communication unit, Synco living central apartment unit QAX9x3</li></ul></li><li>• Devices without a direct connection for the operating voltage:<ul style="list-style-type: none"><li>QAW740 room unit, and operator units RMZ790, RMZ791</li></ul></li><li>• Existing bus power supply. Delivered by:<ul style="list-style-type: none"><li>– DPSU: Synco 700 devices set to "Decentral bus power = On".</li><li>– PSU: Central bus power supply from power supply unit(s).</li></ul></li><li>• Check that the plant is ready for operation.</li></ul>
Note	Commissioning is described in detail in the installation instructions for each individual device.
<b>Checking communication</b>	<p>Communication is active if the following criteria are fulfilled:</p> <ul style="list-style-type: none"><li>• Power supplied to the bus.</li><li>• Time and date set.</li><li>• Device addresses set.</li><li>• Zone addresses set.</li><li>• Devices <u>not</u> in commissioning mode.</li></ul>
Communication of process values	The communication of process values requires that the zones are connected in the devices via the zone addresses (see Section 7.1).

## 3.2 Commissioning with RMZ operator units

---

### Introduction

The Synco 700 type RM controllers can be commissioned with operator units RMZ790 and RMZ791 (but not RMZ791). This is a highly efficient method for small plants, as no commissioning tools are required.

### Note

When commissioning larger systems with area/line couplers, IP routers and room controllers or room thermostats, the OCI700.1 service tool/ACS790 software is recommended.

### Access levels

The operator units provide the option of three access levels. The selected access level is identified by the design of the square, top left. The following applies:

- User level: ■ Black square: Lowest access level, no password.
- Service level: ■ Square with key: Medium access level, no password.
- Password level: ■ Square with key 2: Highest access level, password.

### Commissioning, password level

Commissioning requires access to the password level. From the start page, the user logs in with the password and navigates to the required operating page or operating line via the predefined path.

### Home page

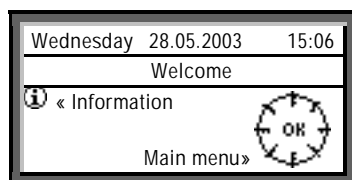

### Action

Press the OK "press-and-select" knob on the operator unit to access the "Main menu" page.

### 3.2.1 Start commissioning, plant mode "Off"

---

Before starting commissioning, it is recommended for safety and technical reasons to switch off the plant, e.g. the fan run-on for electric heating coils. However, this requires that the plant is enabled again when commissioning is complete (see Section 3.2.2).

### Path

■ Main menu > Plant operation > Preselection

### Main menu

On the "Main menu" page, select "Plant operation".

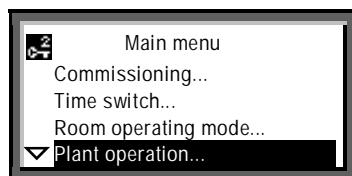

### Action

Press the OK knob to open the "Plant operation" page.

## Plant operation = Off

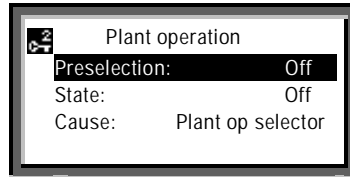

Action Select "Off" on the "Preselection" line and acknowledge by pressing the OK knob.

## Return to main menu

Press ESC to return to the "Main menu" page.

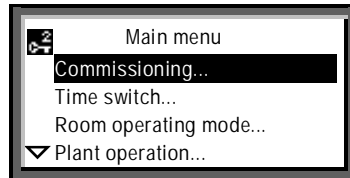

Action Select "Commissioning" and press the knob.

## Plant stops

Before the "Commissioning" page is displayed, the following warning appears:

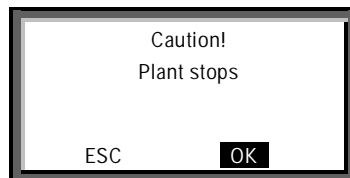

Action Acknowledge the display **OK** by pressing the knob (the plant stops). The "Commissioning" page now appears.

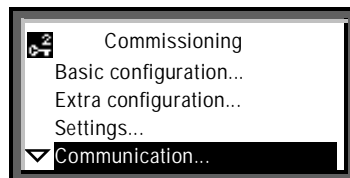

Action Select the "Communication" line for example by rotating the knob, and press the knob to open the "Communication" page.

## Communication

 Main menu > Commissioning > Communication

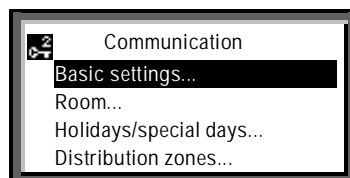

Action Press the knob to access the "Basic settings" page

## Basic settings

 Main menu > Commissioning > Communication > Basic settings

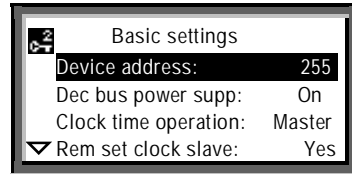

## Notes

Before adjustable values are changed for the first time, the operating lines show the factory-set values, e.g. device address 255.

The factory-settings are also referred to as default values.

## 3.2.2 Finish commissioning, plant mode "Auto"

---

If the plant mode was set to "Plant operation = Off" at the start of commissioning (see Section 3.2.1), it must be reset to "Plant operation = Auto" when commissioning is complete.

## Plant starting

When commissioning is complete (e.g. after "Basic settings", see the operating page above), the repeated pressing of the ESC button results in the following warning:



## Action

Acknowledge the display of **OK** by pressing the knob (the plant is started). The display then returns to the main menu.

## Plant operation = Auto

Before exiting the main menu, press the knob to open the "Plant operation" page.

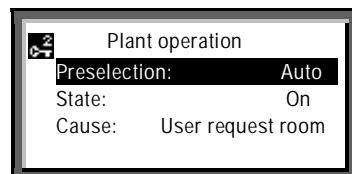
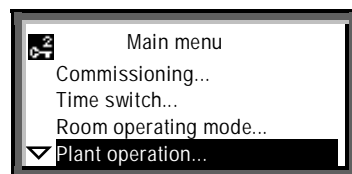

## Action

Select "Auto" (= enable) on the "Preselection" line and acknowledge by pressing the knob. Press ESC to return to the start page.

# 4 Device address and device name

## 4.1 RM... controllers

---

### Introduction

The RMZ790 and RMZ791 operator units are identical for the purpose of access to the RM... controllers and in terms of their application and functions.

The RMZ792 bus operator unit, with same design as the RMZ791, is used for remote access to the Synco 700 bus devices, but differs substantially in terms of application and functions from the RMZ791 and RMZ791 operator units.

### 4.1.1 Read area, line and device address

---

The area, line and device address are factory-set in the RM... controllers. The settings can be read with the RMZ790, RMZ791, and RMZ792 operator units at the Service level (indicated by the  symbol).

### Start page: Selecting the main menu

From the start page, press the OK knob for access to the "Main menu" (see below).

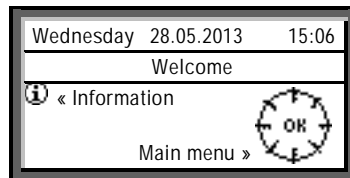

### Note

On delivery from the factory, the start page displays the word "Welcome" instead of the device name.

### Main menu

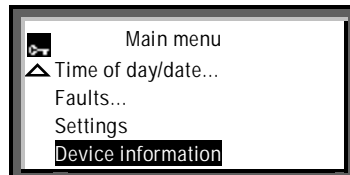

### Note

The bottom of an operating page is indicated by the "Arrow Up" symbol. To access the top of the page, turn the knob counter-clockwise.

### Path to the "Basic settings" page

The path to access the "Basic settings" page containing the factory-set addresses is as follows:

 Main menu > Device information > Communication > Basic settings

### Device information

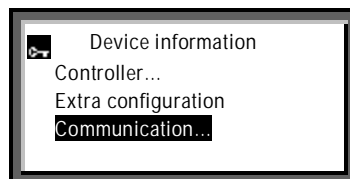

## Communication

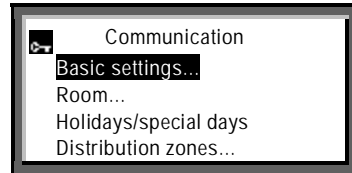

## Basic settings

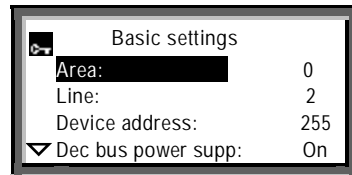

## Notes

With access at the Service level, the setting values on the "Basic settings" page are read-only values. This is indicated by the fact that the black bar does not cover the whole operating line, i.e. the settings themselves are not highlighted.

In small networks, the KNX bus can be commissioned with the factory-set area address 0 (zero) and line address 2. These addresses are permissible only if:

- The Synco bus devices are installed in Area 0 and Line 2 of a network, and not assigned to other areas and lines by means of super-ordinate area and line couplers.

## Read other basic settings

The other basic settings under "Communication" can be read by rotating the knob clockwise.

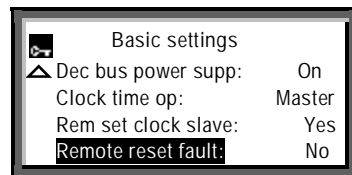

## 4.1.2 Assign device names

---

The RMZ790 and RMZ791 operator units can be used to assign an individual device name (e.g. plant name) to every RM... controller. This device name is displayed on the second line of the start page in the RMZ790 and RMZ791 operator units.

## Home page

On delivery from the factory, the word "Welcome" is displayed instead of the device name.

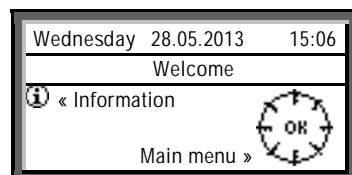

## Assign device names

We recommend that the device name be defined at the design engineering stage. To assign a name, select the Service level  and the following path:

 Main menu > Settings > Texts

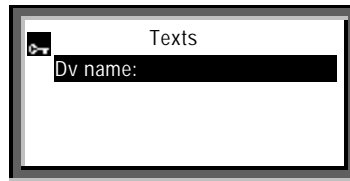

## Action

Write the text, via the "Texts" page and the line "Dv name" (= Device names):

- Turn the knob as required to access the "Device name" page.
- Turn the knob clockwise and select a character.
- Press the knob to import the selected character to the text line.

Save the text line in the device:

- Turn the knob counterclockwise until the **OK** field is displayed.
- Press the knob to save the text line in the device.
- Press ESC (repeatedly) to return to the start page, and check the device name.

## Notes

The device name may contain up to 21 alphanumeric characters (maximum 21 characters including spaces)

Device names cannot be assigned to the Synco 700 RMZ78x extension modules.

A device name can be assigned to each device at the same time as the device address via ACS790.

## 4.2 Set device address with RMZ790 and RMZ791 operator units

### Introduction

Synco bus devices with factory-set device address 255 do not transmit process values. However, these devices can be operated, and the device address can be set. Address range 1...253, excluding 150 reserved for OZW772 web server.

### Setting procedure

Access to the basic communication settings is via the Password Level (symbol ). The device address is set via the "Basic settings" page on the "Device address" line. Proceed as follows:

#### Step 1

 Main menu > Commissioning > Communication > Basic settings

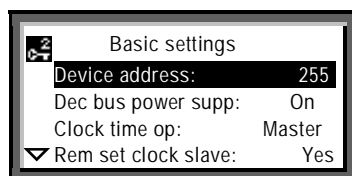

#### Step 2

Turn the knob as required to access setting mode.

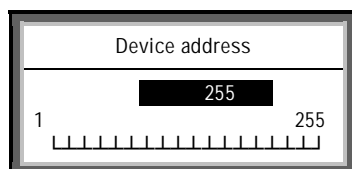

#### Step 3

In setting mode, set e.g. Device address=10 by rotating the knob as required.

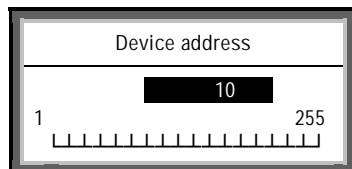

#### Step 4

Press the knob to confirm the setting. An internal test to check for address conflicts is indicated by the hourglass symbol.

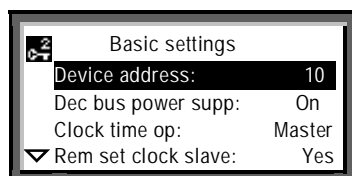

If no more basic settings are modified, the commissioning process must be finished (see Section 3.2.2).

### Note

Device addresses can also be assigned to a device via ACS (see Section 5).



# 5 Device addresses via ACS

## 5.1 Service tool OCI700.1 and ACS790 software

### 5.1.1 Overview

#### Service tool OCI700.1

The OCI700.1 service tool is used to commission and diagnose devices in the Synco, SIGMAGYR and ALBATROS ranges, and to operate plants via the KNX bus or local process bus (LPB) (see data sheet N5655).

When ordering, use type code **OCI700.1**. No license is required for operation. The tool is supplied as a complete kit in a service case:

1. CD-ROM with
  - Operating software
  - Service software
  - Documentation
2. OCI700 service interface
3. USB cable, Type B socket
4. KNX service cable, RJ45 For Synco devices
5. LPB service cable, RJ12 For SIGMAGYR and ALBATROS controllers  
(not illustrated below)

#### OCI700 service interface

The OCI700 service interface converts the signals between the USB port on the PC/laptop and the tool interface on the bus device (RJ45 connection).

There is no need to set parameters for the service interface. Only the central unit (OCI700-KNX) needs to be selected via the software, after which communication is established with the device (and other devices on the bus).

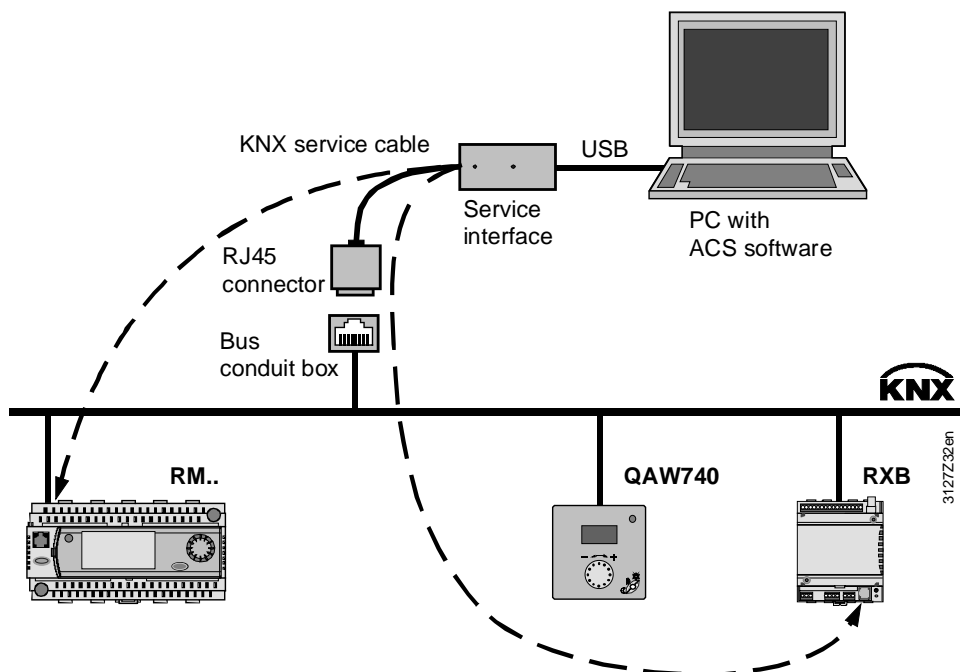

**Synco devices with a tool interface**

The following Synco devices have a tool interface. They can be connected directly to a PC/laptop via the OCI700 service interface.

- RM... controllers
- RX... room controllers
- QAX9x3 central apartment unit
- OZW772 web server

**Note**

All other bus devices have no tool interface. Communication with these devices is possible indirectly, via Synco devices with a tool interface and the KNX bus.

**Bus power supply**

**The OCI700 service interface does not supply power to the KNX bus.**

A central or distributed bus power supply unit is required to communicate via the KNX bus (see Section 2.2).

# 6 Basic communication settings

## 6.1 RM... controllers

### 6.1.1 Distributed bus power

---

The type of bus power supply is set on the "Basic settings" operating page on the "Dec bus power supp" line.

 Main menu > Commissioning > Communication > Basic settings

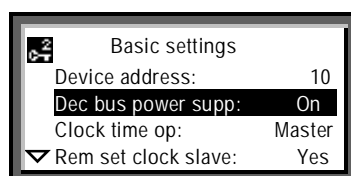

Distributed bus power supply, RM... controllers  
Default value. On.  
Setting values Off/On

Note

In small networks, the KNX bus can be operated with default value "Dec bus power supp: On". See Section 2.2 for information about the bus power supply.

### 6.1.2 Clock time operation

---

"Clock time operation" refers to the transmission of the date and time. For the RM... controllers, this is set on the "Clock time op:" line of the "Basic settings" operating page.

 Main menu > Commissioning > Communication > Basic settings

Clock time operation:  
**Master** (time master)

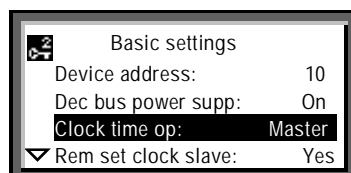

Clock time operation:  
**Slave** (time slave)

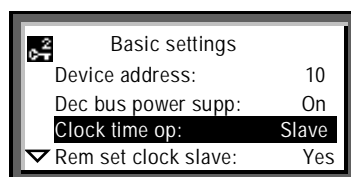

Clock time operation:  
**Autonomous**

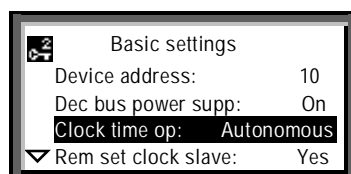

Clock time mode, RM... controllers  
Default value. Master  
Setting values Autonom. / Slave / Master.

Setting values

- Clock time op.: **Autonomous** The RM... controller does not receive or transmit the time or date (The device has its own time and date).
- Clock time op.: **Slave** The RM... controller receives the time and date from the time master.
- Clock time op.: **Master** The RM... controller transmits the time and date in a 10 minute cycle over the KNX bus, starting from the last time-synchronization.

Example

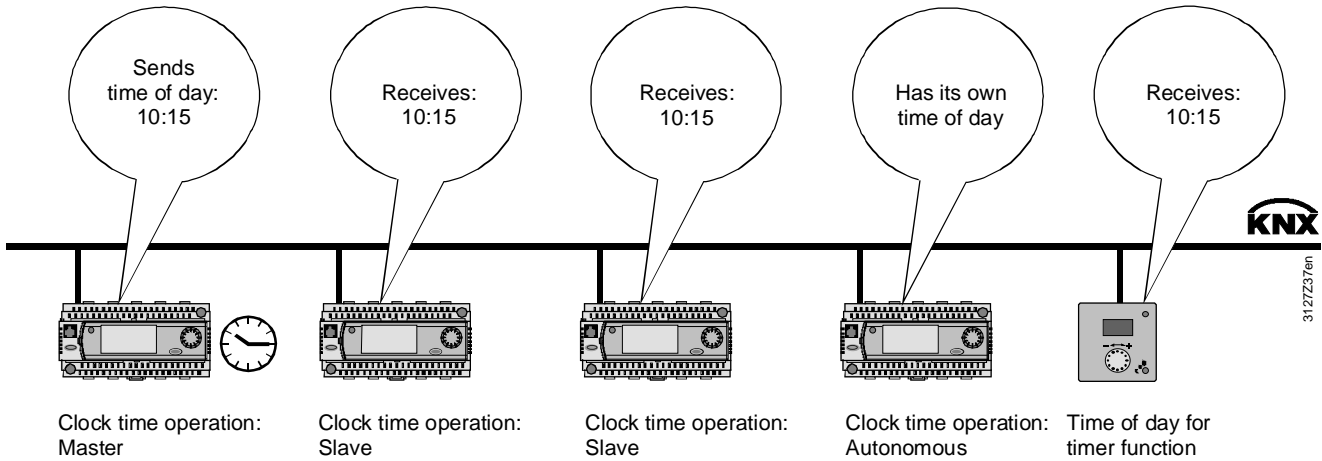

Change time and date

The time and date in the time master can be changed as follows:

- By the user, on the time master.
- By the user, by remote adjustment of the time slave.

A user-adjustment of the time or date can be synchronized by pressing the rotary knob.

Note

Only one bus device at a time can be the time master in a network. In relation to date and time, the other bus devices must be set as time "slaves" or set to "Autonomous."

### 6.1.3 Set time slave remotely

The operating line "Rem set clock slave" can be used to configure a time slave so that the time and date can be set by an operator. The new values are then transmitted via the KNX bus to the time master.

Main menu > Commissioning > Communication > Basic settings

Clock time operation:  
Slave with  
"Rem set clock slave:"  
**Yes**

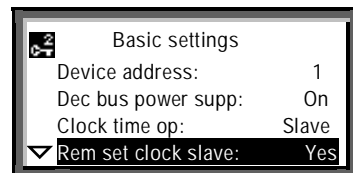

Remote time-slave setting for RM... controller  
Default value. Yes  
Setting values No/Yes

Setting values

Rem set clock slave: **Yes** The time slave transmits the remote time and/or date settings to the time master. The time master transmits the values received to all time slaves (including any remotely adjustable slave(s)).

Rem set clock slave: **No** Time slaves with this setting can only receive the time and date from the time master.

Note

All time slaves can operate with the default setting "Rem set clock slave: Yes". However, it is also possible for only one time slave (or none) to operate with this value.

Example

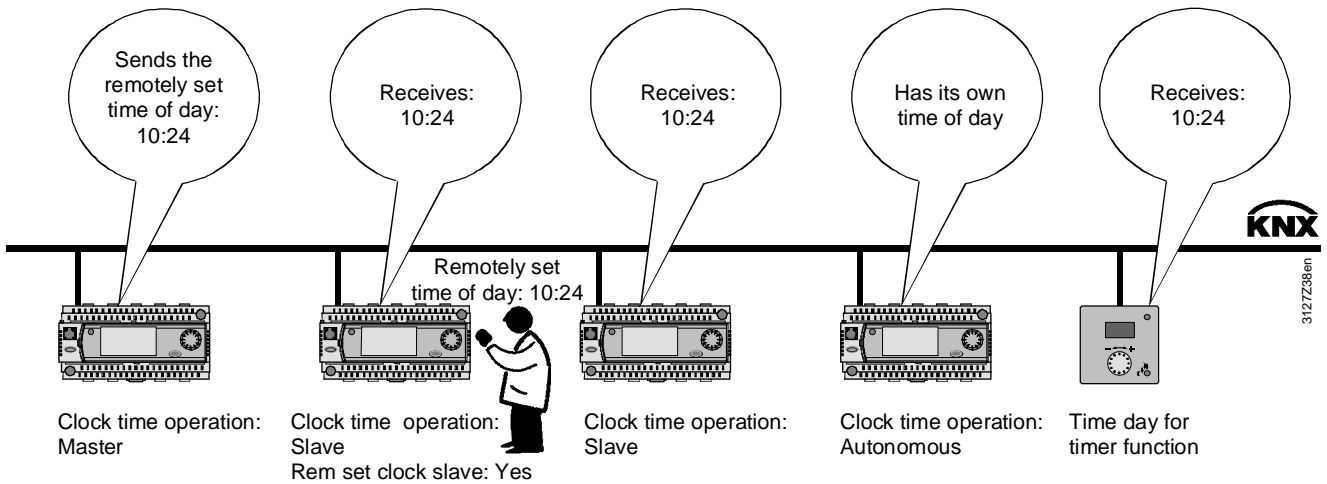

Time in the QAW740 room unit

For its timer functions, the QAW740 room unit requires the time from the time master. It can receive the time over the KNX bus subject to the following criteria:

- A bus device must be defined as the time master (setting "Clock time op: Master").
- The QAW740 room unit is connected to an RM... controller via a "Geogr. Zone (apartm.)". For communication and filtering purposes (see Section 8.2), the time master and the room unit should be in the same "Geogr. Zone (apartm.)". However, this is not mandatory.
- The room unit must have received the time from the time master. Note: The time master transmits the time only every 10 minutes.

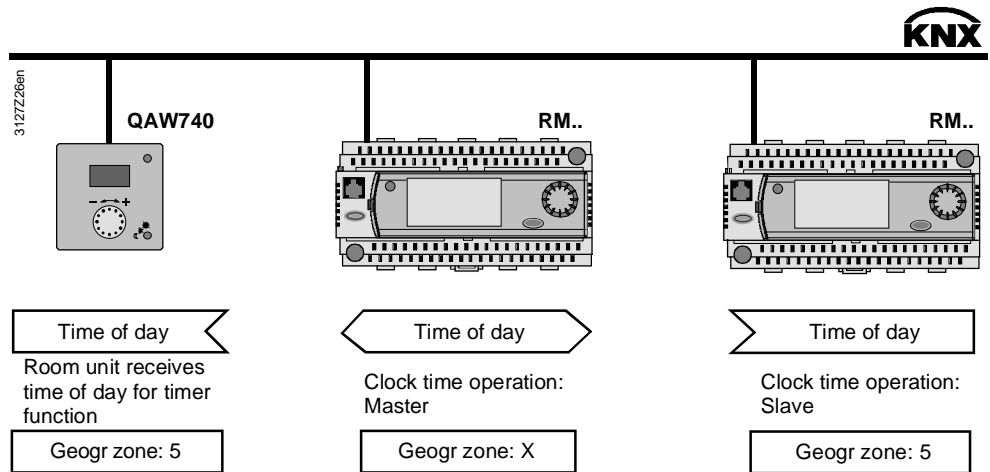

## 6.1.4 Remote reset of fault

---

The "Remote reset of fault" function is used to reset Synco 700 RM... controller faults transmitted over the KNX bus requiring acknowledgement and reset to be acknowledged (and reset if "Remote reset of fault: Yes") with the OCI700.1 service tool, the RMZ792 bus operator unit, the OZW772 web server, and the OZW775 central communication unit.

RM... controllers

 Main menu > Commissioning > Communication > Basic settings

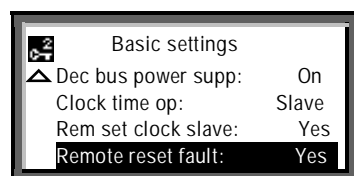

Remote reset of faults for the RM... controllers

Default value.	No
Setting values	No/Yes

Note

Apart from the RMH780 heating controller, all RM... controllers (including the RMH760B heating controller) incorporate the "Remote reset of faults" function.

# 7 Communication via zone addresses

## 7.1 General notes on zones

### 7.1.1 Synco zoning

#### Zones and devices

Zoning on Synco is based on KNX and comprises the following zones for Synco 700 devices, RXB/RXL room controllers, RDG/RDF/RDU room thermostats, GxB181 VAV controller, AQR flush-mounted sensors, and QMX3 room units:

Designation	RMU	RMH	RMK	RMB	RMS	QAW	QAX9..	RXB/RXL	RD..FCU	RD..VAV	GxB181..	AQR....	QMX3...	Zone address range
Geographical zone (apartm.)	x	x	x	x		x		x	x	x	x	x	x	1...126
Geographical zone (room)	x			x				x	x	x	x	x	x	1...63
Geographical zone (subzone)								x	x	x	x	x	x	1...15
Time switch zone (apartment)								x						1...126
Time switch zone (room)								x						1...63
Time switch zone (subzone)								x						1...15
Time switch slave (apartment)	x	x	x		x									1...126
Master/slave zone (apartment)								x						1...126
Master/slave zone (room).								x						1...63
Master/slave zone (subzone)								x						1...15
QAW op.zone (apartment)				X										1...126
Heat distribution zone	x	x			x		x		x	X				1...31
Heat distr zone source side	x	x		x	x									1...31
Heat distr zone consumer side	x	x		x										1...31
Heat distr zone heating surface								x						1...31
Heat distribution zone air heater.								x						1...31
Heat distrib. zone, primary distr.			x											1...31
Heat distrib. zone, primary ctrller			x											1...31
Refrigeration distribution zone	x				x		x		x	x				1...31
Refrig distr zone source side	x			x	x									1...31
Refrig. distr zone consumer side	x			x										1...31
Refrig distr zone cooling surface								x						1...31
Cold distribution zone air cooler.								x						1...31
Air distribution zone	x									x	x			1...31
Boiler sequencing zone			x											1...16
DHW zone		x												1...31
Holiday/special day zone	x	x	x	x	x									1...31
Time switch, DHW slave		x												1...31
Outside temperature zone	x	x	x	x	x		x	x	x	x				1...31
Solar zone		x												1...31
Wind zone		x												1...31
LTE reception zone	x			x	x									1...4095
LTE transmission zone	x			x	x							x	x	1...4095

Note:  $\underline{x}$  = fixed zone address (cannot be adjusted):

- Outside temperature zone = 31
- Subzone = 1

## 7.1.2 Communication of process values

### LTE-Mode

In LTE-Mode (LTE = Logical Tag Extended), the communication bindings between data points are created by means of logical tags. This is the equivalent of the zone addresses in Synco.

Zone addressing, i.e. the setting of a zone address is also referred to as "binding".

### Communication of process values

A common zone address is all that is necessary for the process values to be exchanged between the devices in a zone.

A further requirement is that the device address should be set in the devices.

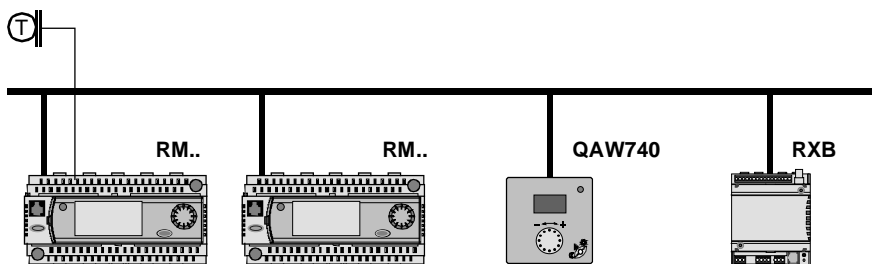

312729en

Device address	1	2	9	44
Process value	Outside temperature	Outside temperature		
Zone: Address	Outside temp zone: 2	Outside temp zone: 2		
Process value		Room temperature	Room temperature	
Zone: Address		Geogr zone: 1	Geogr zone: 1	
Process value	Heat requis	Heat demand		Heat demand
Zone: Address	Heat zone: 1	Heat zone: 1		Heat zone: 1
Process value	Time switch value	Time switch value		Time switch value
Time switch operation	Master	Slave		Slave
Zone: Address	Geogr zone: 2	TS slave: 2		TS slave: 2



### 7.1.3 Geographical zone (apartment)

#### Definition Geographical zone

The term "Geographical zone (apartment)" is specified by KNX and implies a building divided into geographical (physical) zones. However, in practice it is related to the operating strategy, which is defined as follows:

- One "Geographical zone (apartment)" consists of a number of buildings or parts of buildings which are grouped together from an operational point of view and which obey the following criteria:
  - Same room operating mode.
  - Same room temperature (setpoint, actual value).

Based on this definition, the "geographical zone (apartment)" might better be referred to as an "operating zone".

The "Geographical zone (apartment)" is used together with RM... controllers, RXB/RXL room controllers, RDG/RDF/RDU room thermostats, and QAW740 room unit.

 Main menu > Commissioning > Communication > Room

RM...controllers

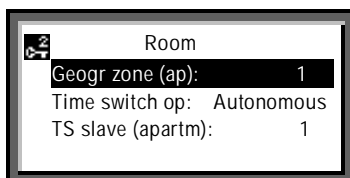

RM...B controllers

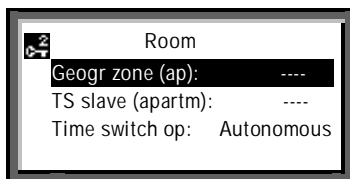

Geographical zone (apartment)	
RM... default	1
RM... B default	----
Setting values	1...126

Note

The "Room" operating page and some other operating pages for the RM... controllers (RMU7x0 and RMH769) differ from those for the RM...B controllers (series B devices).

#### Communication of the room temperature

Communication of the room temperature from the QAW740 to an RM... controller via "Geogr. zone 5":



## 7.1.4 Default value "----" in series B devices

---

### Introduction

The "Geographical zone (apartment)" represents the room to be controlled. Within this zone, all process values relevant to the room are transmitted (e.g. room operating mode, room setpoint and measured room value, plus user intervention and other influences).

### Setting values

The factory setting or default value for the RM... series B controllers is "---". This default value indicates that the zone is "out of service", i.e. no relevant process values are transmitted within this zone.

 Main menu > Commissioning > Communication > Room

Operating line	Range	Factory setting or default value
Geographical zone (apartment)	----, 1...126	----
Time switch slave (apartment)	----, 1...126	----

### Note

Factory setting or default value "----" applies to all RM... series B controllers.

### Autonomous controller

In the "Autonomous controller" application, a ventilation system is controlled independently of other plant, according to its own room operating conditions. For this application there is no need to set a zone address for the "Geographical zone (apartment)", i.e. the default "----" can be left as is.

**Two controllers with identical room occupancy times**

Function "Time switch operation"

If the room occupancy times for various "geographical zones" are identical, one controller can be defined as the time switch master.

The other controller or controllers act as slaves, and adopt the occupancy times in the master.

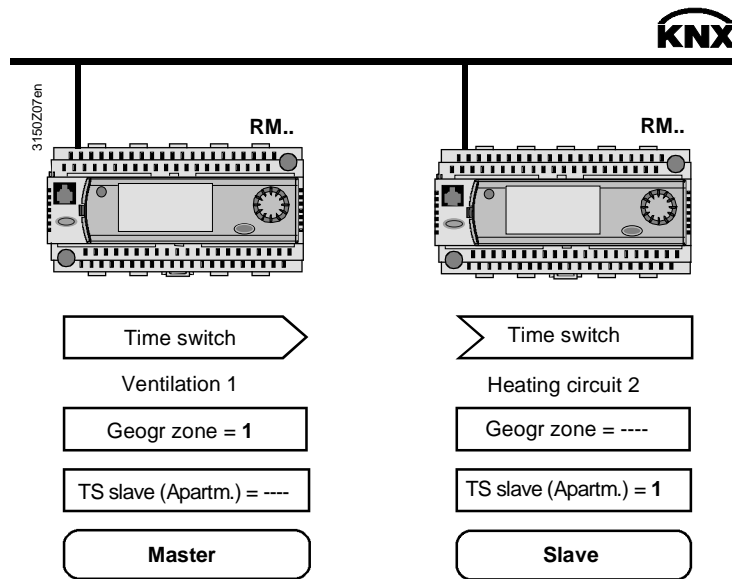

**Notes**

With regard to room occupancy times, the "Heating circuit 2" controller is the slave of the controller of "Ventilation 1", because the setting "Time sw. slave (apartm.) = 1" means that time switch operation is adopted by "Geogr. Zone = 1" i.e. by the controller of "Ventilation 1".

In terms of the room operating mode, the "Heating circuit 2" controller operates autonomously, see "Geogr. zone = ----" in the illustration.

Only one controller may be the time switch master in any one zone. The setting for the master is "TS slave (apartm.) = ----".

A time switch master can control one or more time switch slaves in different zones. The setting for the slaves is "TS slave (apartm.) = x" where x = 1...126, the zone address of the time master.

For a detailed description of time switch operation with the RMU7x0B controller, see the technical principles document P3150.

**Device-specific communication**

Communication via zone addresses for specific devices is described in the basic documentation for the Synco 700 RM... controllers. These descriptions are all in the "Communication" section.

The titles and document numbers are as follows:

- Universal controller RMU710B, RMU720B, RMU730B P3150
- Modular heating controllers RMH760B P3133
- Boiler sequence controller RMK770 P3132
- Central control unit RMB795B P3121
- Switching and monitoring device RMS705B P3123

For information on the room controllers, see document:

- FNC – Description of functions RXB/RXL CM110385

## 7.1.5 LTE reception and transmission zones

---



<b>Definition</b>	Some Synco devices allow for universal exchange of data on input and output terminals via KNX bus.
Principle of operation	<ul style="list-style-type: none"><li>• Universal inputs, digital and analog outputs can be used as transmission objects (for transmission zones).</li><li>• Universal inputs can be used as reception objects (in reception zones).</li><li>• Data is exchanged as if the device terminals were connected by wire.</li></ul>
Number of reception/transmission zones	Max. 32 reception and transmission zones each are allowed per line.
Note	Due to KNX bus-specific issues (e.g. transmission frequency), allowed or not allowed applications must be noted:
Examples for allowed applications	Use of universal transmission and reception zones is allowed and meaningful: <ul style="list-style-type: none"><li>• To control decentralized aggregates such as motors, pumps, etc.</li><li>• For simple control functions that are not time-critical.</li><li>• Common processing or use of bus information.</li></ul>
Examples for not allowed applications	The following applications or input/output variables must <b>not</b> be implemented by means of universal transmission and reception zones: <ul style="list-style-type: none"><li>• Safety-related plants and equipment (e.g. fire shutdown, smoke extraction, frost protection).</li><li>• If "simultaneous startup response of plants is active.</li><li>• Applications where communications failure of transmission or reception zones can cause damage.</li><li>• Control paths that are time-critical or more sophisticated (e.g. speed control via pressure, humidity).</li><li>• Compulsory main control variables that must be available.</li><li>• Acquisition and evaluation of pulses.</li></ul>
Note	After power-up, a short time may pass until the bus signals are available. Fault plant behavior may result in the case of not allowed applications of the transmission and reception zone.
<b>Activate</b>	To activate the function, the desired transmission or reception zone must be set at a terminal in the device. The partner device must be set accordingly.
Note	Transmission/reception operations are a 1:n-ratio, i.e. a transmission/reception zone may contain one "transmitter", but several "receivers". A value can be sent and received via the input terminal. Via the output terminal, a value (digital or 0...10V) can only be sent.



Example 1

RMS705B (device 1) contains the air quality value of an air quality sensor. This value is transmitted as transmission object via an analog output and further processed by a RMS705B (device 2).

Data exchange concept

The following transmission and reception zone is engineered for our example:

<i>RMS705B, device 1</i>		<i>RMS705B, device 2</i>		<i>Value</i>
Terminal	Transmission zone	Terminal	Reception zone	
N.Y1 	1	N.X1 	1	Air quality mean value

 = Transmit  
 = Receive

Configuration

Device 1

The following is configured in RMS705B, device 1:

 Main menu > Commissioning > Communication > LTE transmission zones >

<i>Operating line</i>	<i>Range</i>	<i>Factory setting</i>
N.Y1	1	

Device 2

The following is configured in RMS705B, device 2:

 Main menu > Commissioning > Extra configuration > Input identifier >

<i>Operating line</i>	<i>Range</i>	<i>Factory setting</i>
N.X1	ppm	

 Main menu > Commissioning > Communication > LTE reception zones >

<i>Operating line</i>	<i>Range</i>	<i>Factory setting</i>
N.X1	1	

## 7.2 Address zones with RMZ operator units

### 7.2.1 RM... controllers

#### Introduction

For the Synco 700 RM... controllers, the zone addresses can be set with the RMZ790 and RMZ791 operator units. The zone addresses can be set without commissioning tool, also referred to as "Easy configuration".

#### Setting procedure

Access at the Password level  opens the operating pages and operating lines. To set the zone address, use the following path to the "Room" operating page: This is where the geographical zone is set.



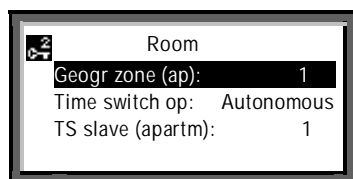

 Main menu > Commissioning > Communication > Room



### 7.2.2 QAW740 room unit

#### Setting procedure

The QAW740 room unit only contains the "Geographical zone (apartment)". The zone address can be set via the operator controls on the front of the unit.

Step	Action	Operating element
1	To access the setting mode, press the presence button for ca. 6 seconds. Letter <b>A</b> is displayed and the zone address can be set.	
2	Set the zone address with the rotary knob. In this example, the value is 5, thus <b>A 5</b> Note: <b>A</b> stands for "Geographical zone ( <b>A</b> partment)"	
3	Briefly press the presence button again to go to other settings (to set values with rotary knob, see Step 2).	
4	After setting the zone address, press the presence button to exit setting mode.	

#### Note

Zone addresses in the range 1...126 can be set for the "Geographical zone (apartment)" in the QAW740 room unit.

# 8 Large plants

## 8.1 Engineering and commissioning

---

<b>Large plants</b>	In large projects, observe the following points during the engineering and commissioning.
Distances and line lengths	For all lines, observe the distances and line lengths (see Section 2.3.1). If the topology exceeds the prescribed limits, use area/line couplers.
Number of bus devices	Max. 64 bus devices may be installed on one line. In plants with more than 64 bus devices, the bus devices must be distributed to different lines and/or areas (see Section 2.1.2).
Area/line couplers	When structuring large plants, LTE-compatible area/line couplers are required (see Section 1.4).
IP routers	For the "KNX to IP network" connection, LTE-compatible IP routers are required (see Section 1.4).
Predefined filter table	The area/line couplers and IP routers must contain the predefined LTE filter table (see Section 8.2).
Alarm sinks	Alarm sinks should be on the same line or the next higher line in the hierarchy (see Section 8.1.1, example 2). Alarm sinks: <ul style="list-style-type: none"><li>• OZW771 central communication unit</li><li>• OZW775 central communication unit</li><li>• OZW772 web server</li><li>• RM... controllers with enabled fault relay.</li></ul>
Devices with room functions	Devices with room functions should be located on the same line as the devices with which they exchange data via KNX in LTE-Mode, i.e.: <ul style="list-style-type: none"><li>• Synco QAW740 room unit ↔ Synco RM... controllers</li><li>• RXB/RXL room controllers ↔ Synco RMB795B central control unit</li><li>• Room thermostats RDG/RDF/RDU ↔ Synco central control unit RMB795B</li><li>• Synco RM... controllers for room control combinations (see Section 9.3)</li></ul>
Clock time master	Only one bus device in the network may be configured as the time master (see "Time synchronization" in Section 6.1.2).
ACS790 software	A search via ACS for devices in all areas and lines only works with correctly addressed area/line couplers.
Design rules for zone addressing	Observe the following rules when addressing zones: <ul style="list-style-type: none"><li>• The zone addresses, which can be filtered, are permanently predefined in the LTE filter table (see Section 8.2). For this reason, both the assignment of devices to areas and lines, and the addressing of the zones must be planned with extreme care.</li><li>• Keep data traffic to the minimum by creating "communication islands" (see Section 1.4).</li><li>• There is a limit to the number of LTE telegrams that can be transmitted via area/line coupler and IP router (see Section 8.2.4).</li></ul>

## 8.1.1 Network topologies

Three network topologies are illustrated on the next three pages. Note among others the details of the LTE filter table (see Section 8.2).

### Example 1

### KNX network with area and line couplers

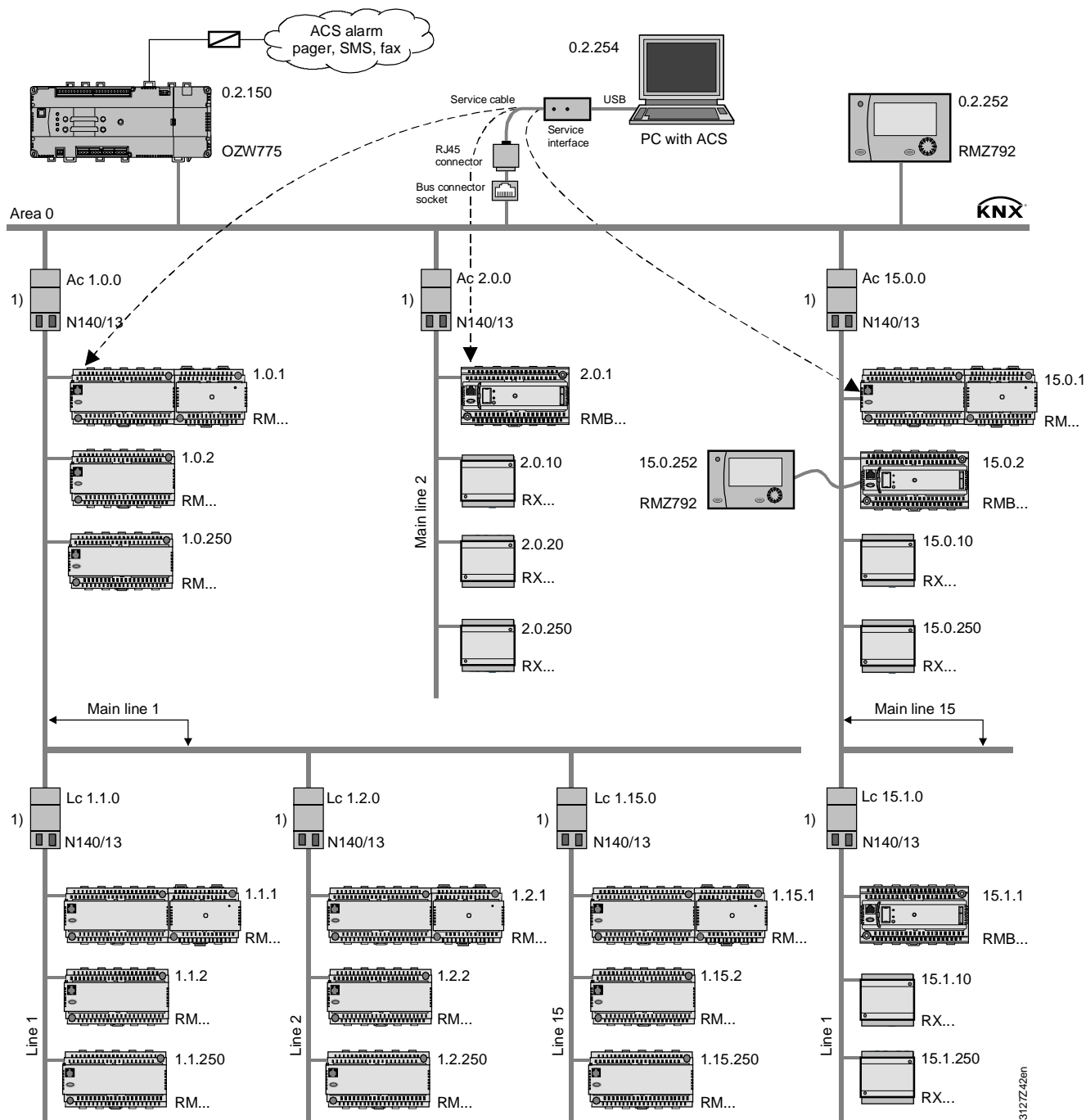

LTE filter table: 1) Normal (route)

### Note

As previously stated, one line (KNX TP1) can accommodate max. 64 bus devices. The addresses (x.y.250) should refer to the highest recommended bus device address (250), not the max. possible number of bus devices.



## Example 2

## KNX network linked via IP router to IP network (area line 0)

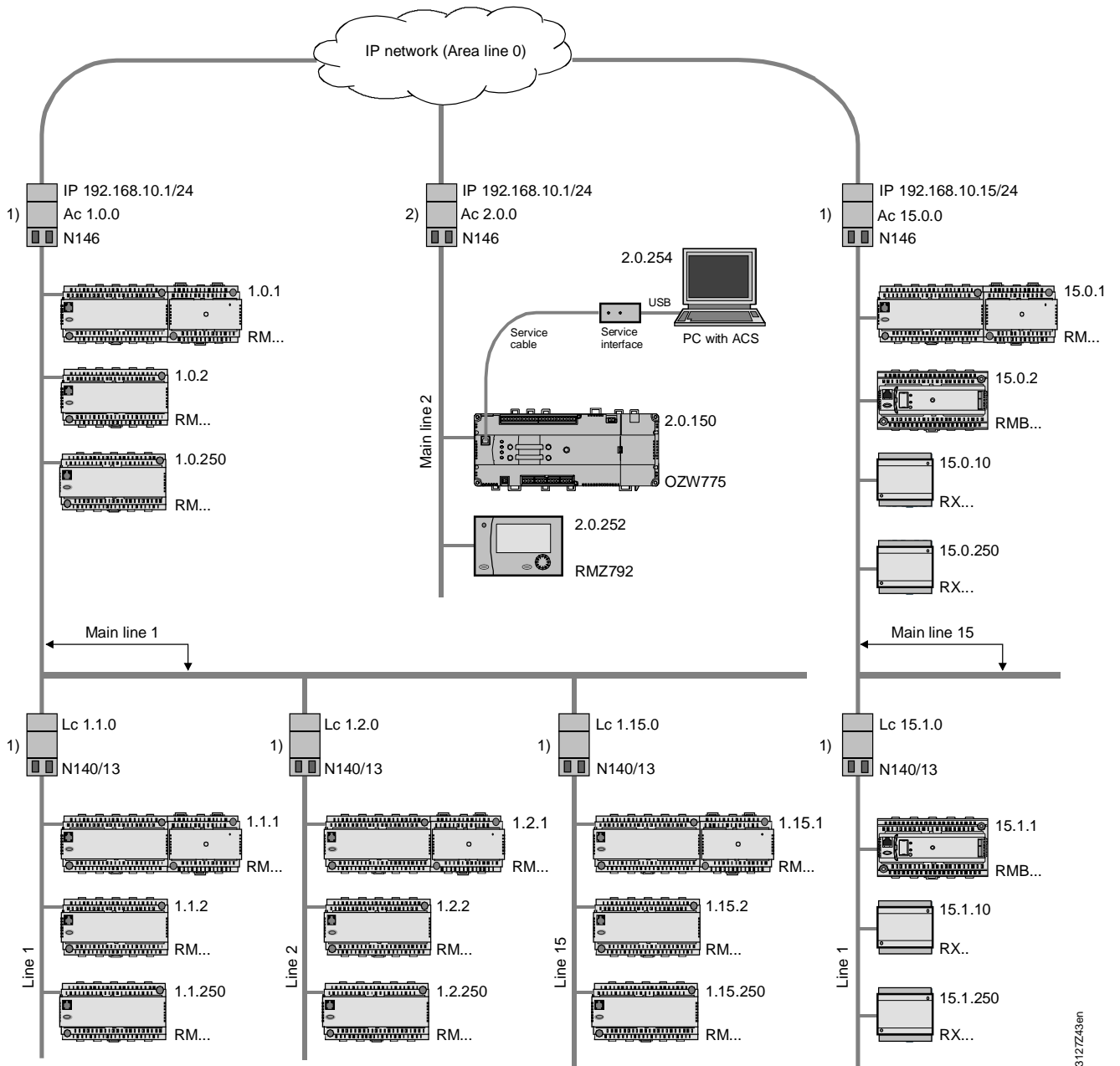

312Z43en

LTE filter table: 1) Normal (route), 2) Route all

### Alarm sinks

If Synco devices are used as alarm sinks (see the OZW775 central communication unit and RMZ792 bus operator unit in the figure), these alarm sinks must be installed directly after an IP router.

### Alarm signals

To enable alarm sinks to receive all alarm signals (and other data) from the IP network, the IP router filter must be set to "Route all" (see Sections 8.2.1 and 8.2.5).

**Example 3**

**KNX network with third-party devices in area 15**

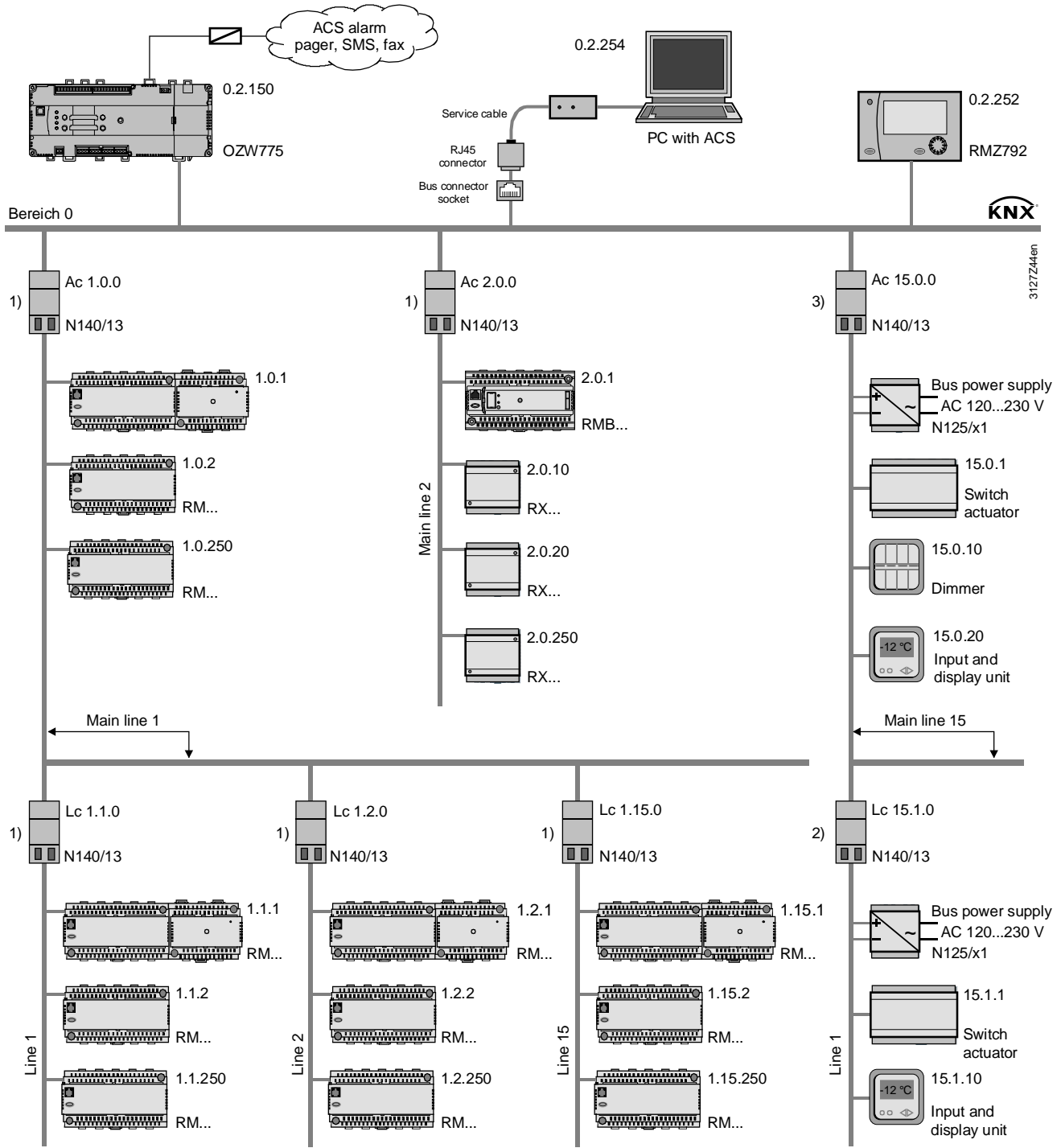

LTE filter table: 1) Normal (route), 2) Route all, 3) Block all

**LTE filter table**

If the filter is set to "Block all" for area coupler Lc 15.0.0, no LTE telegrams are transmitted between area 15 and the rest of the network. The "Route all" setting for line coupler Lc 15.1.0 means that there is no filtering between line 15.1 and main line 15.

**Bus power supply**

If the devices in area 15 (e.g. third-party products) do not supply power to the bus, an N125/x2 power supply unit must be installed in each line (main line 15, line 15.1 plus 2 further lines 15.x, if applicable) for the bus power supply.

## 8.1.2 IP router as coupler to IP network

### 10BaseT interface

The router can be connected to the IP network via Ethernet cable and the RJ45 socket of the IP router.

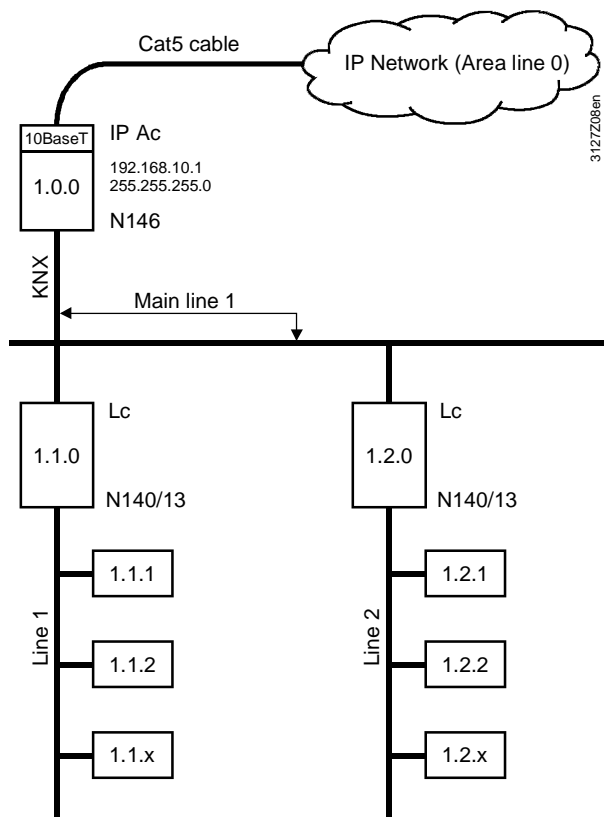

The IP router has a 10BaseT interface (Ethernet at 10 Mbps via Cat5 cable).

### Rules

Observe the following rules when using IP routers:

- With an IP router used as an area coupler (IP-Ac), no other IP routers may be installed below the IP-Ac in the topology.
- With an IP router used as a line coupler (IP-Lc), no other IP routers may be installed above the IP-Lc in the topology.

### Assign IP addresses

When IP routers are used for coupling to an IP network, the following issues must be discussed with the IP network administrator:

- Automatic address assignment via DHCP (see Section 8.3),
- **Manual IP address assignment** (see Section 8.3)  
and also:  
IP routing multicast. addr.  
IP subnet mask  
IP standard gateway

### Note

This document does not deal with the technical aspects of Ethernet communications.

## Point-to-point connection

With a "point-to-point connection", the Ethernet cable forms area line 0, regardless of whether the coupling applies to two areas or lines (see figure) or one area with one line.

A crossed Ethernet cable is required to couple two IP routers.

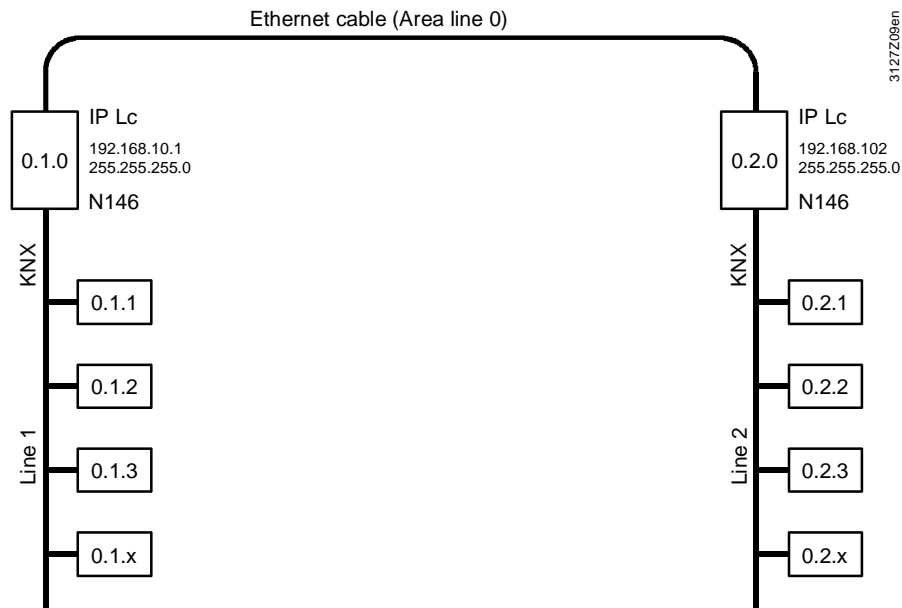

## Multiple connections

A switch box is required for multiple IP router connections. As part of the IP network, the switch box represents area line 0.

Use straight Ethernet cables to connect IP routers to the switch box.

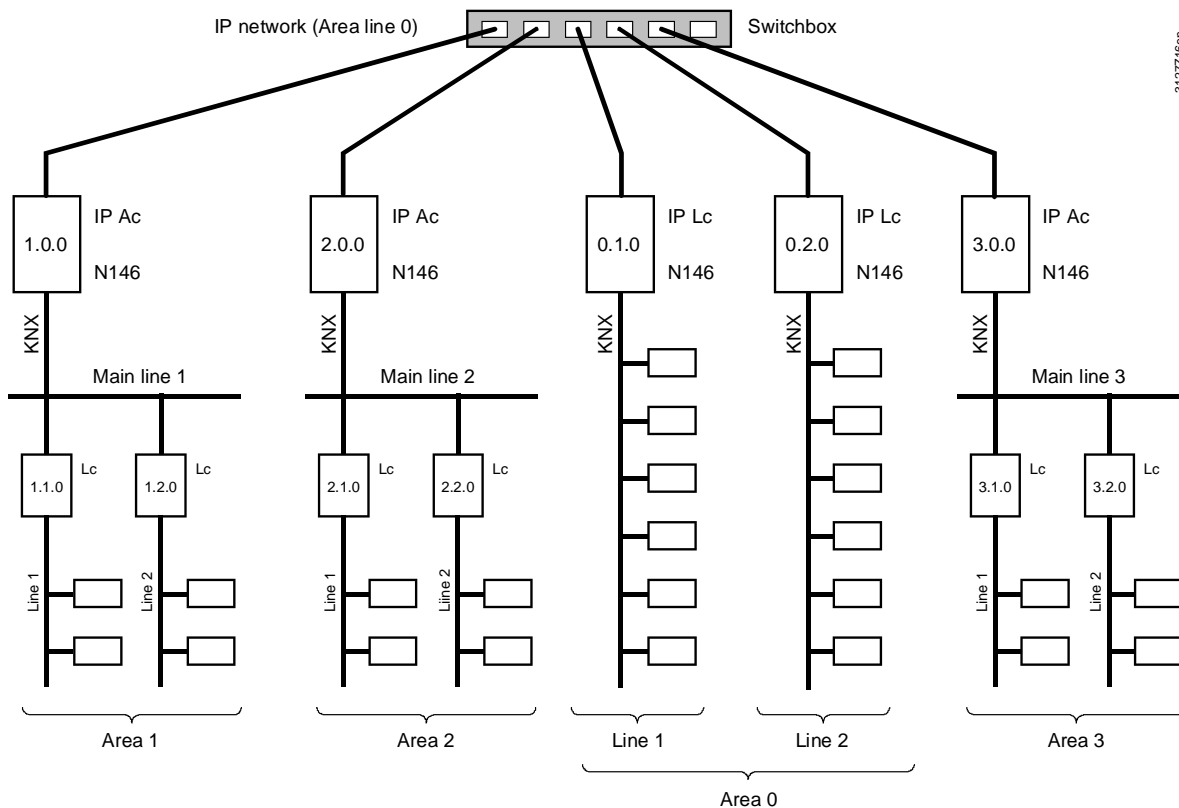

## IP router as area coupler

When the selected method of coupling is "IP router as area coupler", two or more KNX areas are linked via an IP network. The IP routers are used to link main lines, i.e. they must be addressed on the KNX side as area couplers.

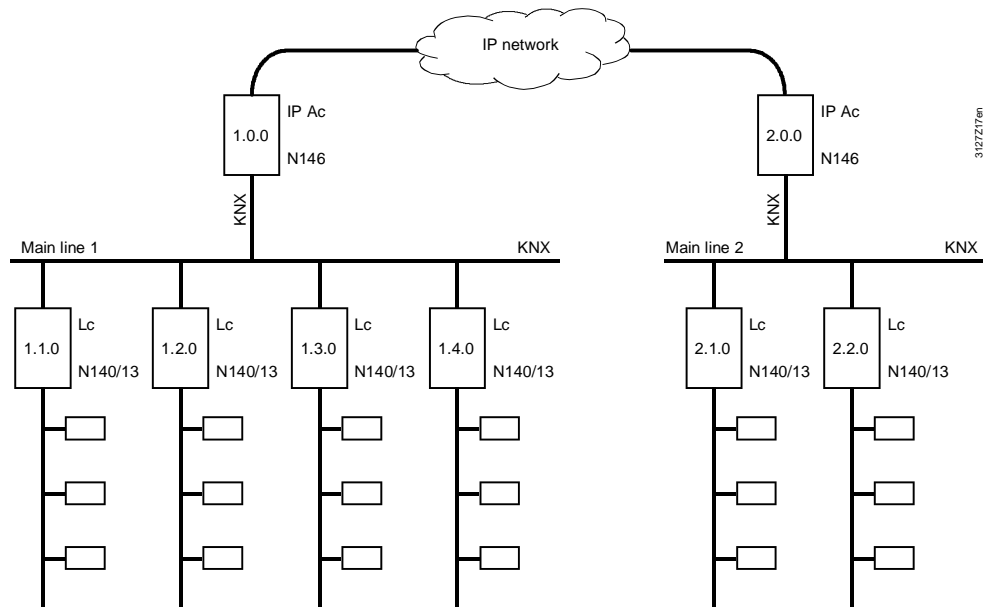

KNX area 1 (main line 1) – IP network – KNX area 2 (main line 2)

3127217en

**IP routers as couplers between "worlds"**

IP routers are also used to link "worlds". This method helps couple two or more KNX networks via an IP network

In this case, the IP routers connect the IP network to the KNX area line 0 of each involved KNX network. The IP routers in all KNX networks must be set to KNX address 0.0.0.

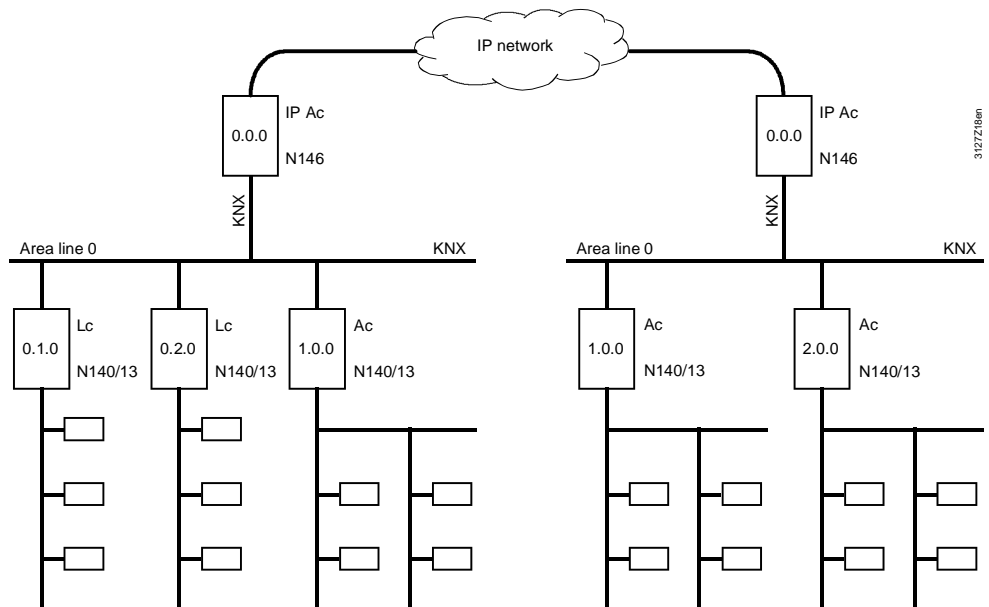

KNX network 1 (area line 0) – IP network – KNX network 2 (area line 0)

3127218en

## 8.2 LTE filter table for couplers and IP routers

---

### Introduction

Area/line couplers and IP routers with an integrated LTE filter table allow for filtering LTE telegrams to reduce the amount of data traffic.

The LTE filter tables are only valid for Siemens area/line couplers N140/x3 and Siemens IP router N146.

Note: S-Mode telegrams are not subject to LTE filtering.

### 8.2.1 Filter settings

---

Filter settings in area/line couplers and IP routers:

- Normal (route) LTE telegrams of predefined zones and zone addresses are filtered (see table in Section 8.2.2).
- Route all All LTE telegrams are routed.
- Block all All LTE telegrams are blocked.

The required filtering mode is selected in ACS790 via `Applications > Popcard...` for the data point "LTE telegrams".

## 8.2.2 Predefined LTE filter table

### Filter setting "Normal (route)"

The predefined LTE filter table is available in the Siemens area/line coupler N140/x3 from Version R2, and in the Siemens IP router N146 from Version R4. The filter setting "Normal (route)" either blocks or routes the LTE telegrams from the zones and zone addresses.

Zones	LTE telegrams of the following zone addresses are...	
	Disabled	Routed
Geographical zones <sup>1)</sup>	1...110	111...126
Heat distribution zones <sup>2)</sup>	1...15	16...31
Refrig. distribution zones <sup>3)</sup>	1...15	16...31
Air distribution zone	1...15	16...31
Boiler sequencing zone	1...8	9...16
DHW zone	1...15	16...31
Holiday/special day zone <sup>4)</sup>	1...15	16...31
Outside temperature zone <sup>4)</sup>	1...15	16...31
Solar zone <sup>4)</sup>	1...15	16...31
Wind zone <sup>4)</sup>	1...15	16...31
LTE transmission zones	1...3839	3840...4095
LTE reception zones	1...3839	3840...4095

### Note

The zone address in the filter table with the attributes "Blocked" or "Routed" are predefined and these attributes cannot be modified.

- 1) The geographical zones comprise:
  - Geographical zone (apartm.), ... (Room), ... (Subzone)
  - Time switch zone (apartment)... (Room), ... (Subzone)
  - Time switch slave (apartment)
  - Master/slave zone (apartm.), ... (Room), ... (Subzone)
  - QAW op.zone (apartment)
- 2) The heat distribution zones comprise:
  - Heat distr zone source side
  - Heat distr zone consumer side
  - Heat distr zone heating surface
  - Heat distribution zone air heater
  - Heat distrib. zone, primary distr.
  - Heat distrib. zone, primary ctrller
- 3) The refrigeration distribution zones comprise:
  - Refrig distr zone source side
  - Refrig. distr zone consumer side
  - Cold distribution zone air cooler.
  - Refrig distr zone cooling surface
- 4) In these zones only one devices transmits LTE telegrams to several devices. Example: The device to which the outside temperature sensor is connected, measures the outside temperature. Only this device transmits the outside temperature value to the other devices which also need this value (multiple use of sensor values).

## 8.2.3 Filtering, zone addresses, communication areas

The diagrams below show the relationship between filter settings, zone addresses and communication areas, based on the zone addresses for distribution zones.

Prerequisite: All area/line couplers and IP routers in the network must have the same filter setting.

LTE telegrams with zone addresses 1...15 are communicated only within the line, i.e. telegrams with these zone addresses are blocked.

LTE telegrams with zone addresses 16...31 are communicated outside that line, i.e. telegrams with these zone addresses are routed.

### Normal (route)

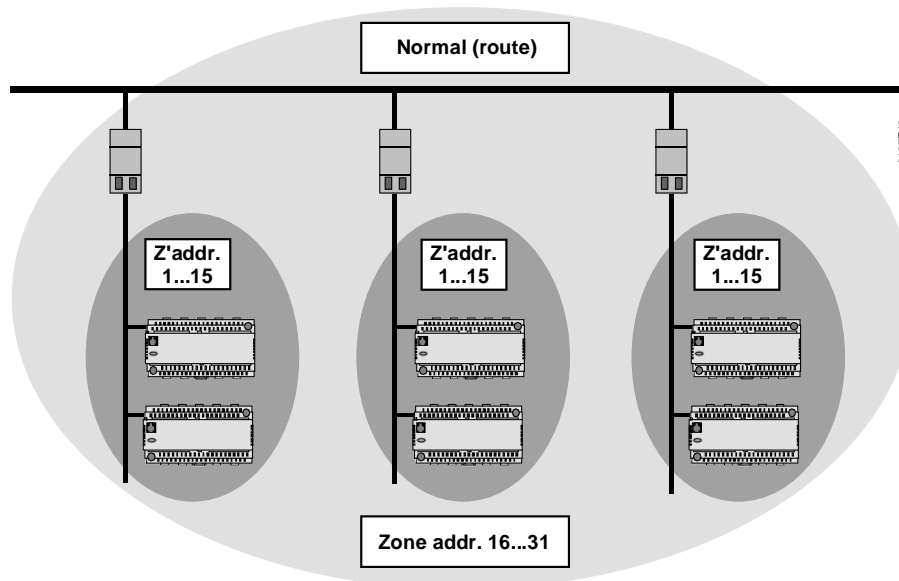

### Note

Zone addresses blocked by filter setting "Normal (route)" can be reused in other KNX areas and lines, but only if attribute "Normal (route)" is valid.

### Route all

All LTE telegrams with zone addresses 1...31 are communicated throughout the network (no filtering).

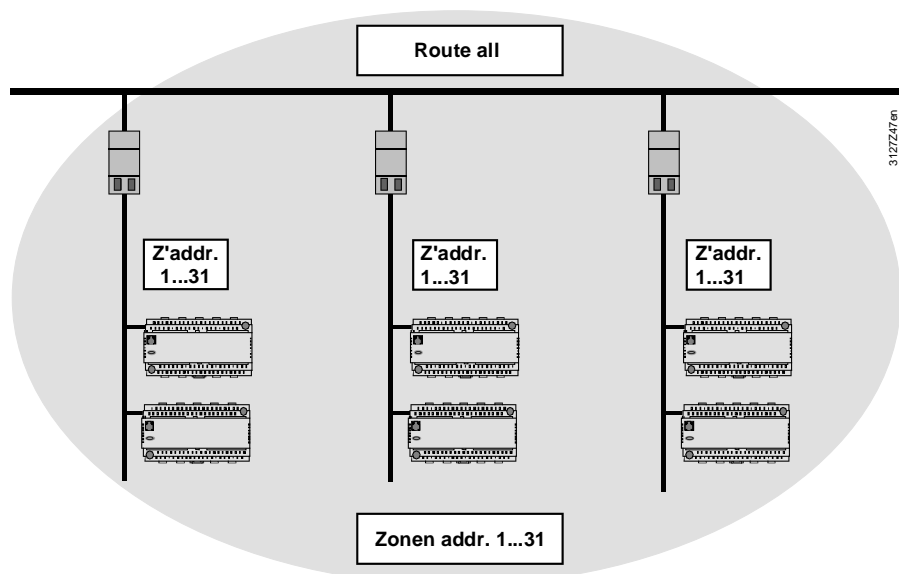



## Block all

All LTE telegrams with zone addresses 1...31 are communicated only within the line concerned.

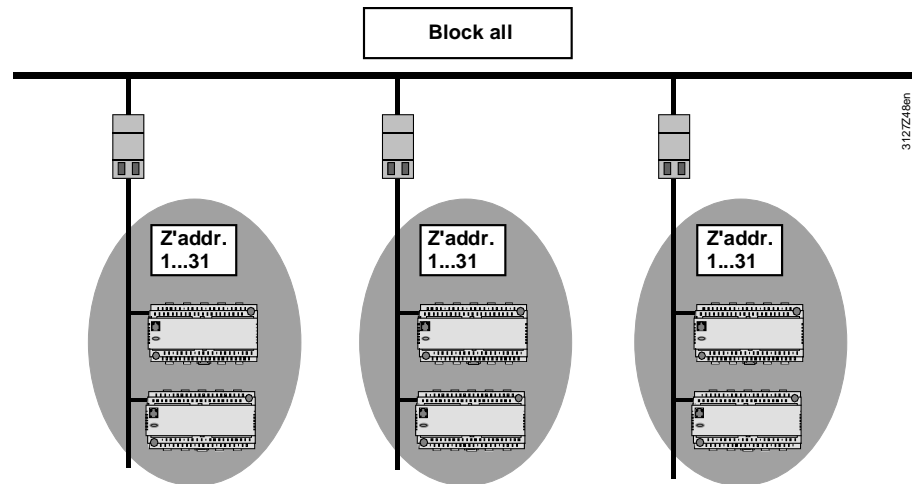

## 8.2.4 LTE telegrams via couplers and IP routers

### Recommendation

**When using Siemens area/line couplers and IP routers together with Synco devices, we recommend to configure no more than 15 devices with the same zone (e.g. heat distribution zone) and the same zone address (see the addresses highlighted in green in Section 8.2.2).**

### Notes

The reason for this recommendation is that the area/line couplers and IP routers have limited buffers.

The aim is to prevent transmission of too many LTE telegrams (e.g. heat demand signals from more than 15 devices) in the same cycle.

If it is possible in a given plant to ensure that only a small number of LTE telegrams is transmitted in the same cycle or that the telegrams are short, it is acceptable to configure more than 15 devices with the same zone and zone address. However, observing the recommendation ensures reliable data communication at all times.

The "Block all" filter setting prevents all data communication via the area/line couplers and IP routers. In this case, the recommendation can be ignored.

### Zones

The above recommendation does not apply to all zones, only to those listed below (see table in Section 8.2.2).

- Geographical zones
- Heat distribution zones
- Refrigeration distribution zones
- DHW zone
- Air distribution zone
- Boiler sequencing zone

**Network with RX... room controllers**

The recommendation on the previous page is particularly important with regard to a network with a large number of RX... room controllers.

In a line containing up to 62 RX... room controllers, an RMB795B central control unit is used as "collector". The area/line couplers are set to "Normal (route)".

The heating and refrigeration distribution zone in each RX... room controller is configured with a zone address in range 1...15 (data communication within the line).

The heating and refrigeration distribution zone in each RX... room controller is configured on the consumer side with a zone address in range 16...13 (data communication via area/line coupler).

The heating/refrigeration demand from the RX... room controllers is transmitted by the "collector" to the RMH primary heating and RMU primary refrigeration controllers.

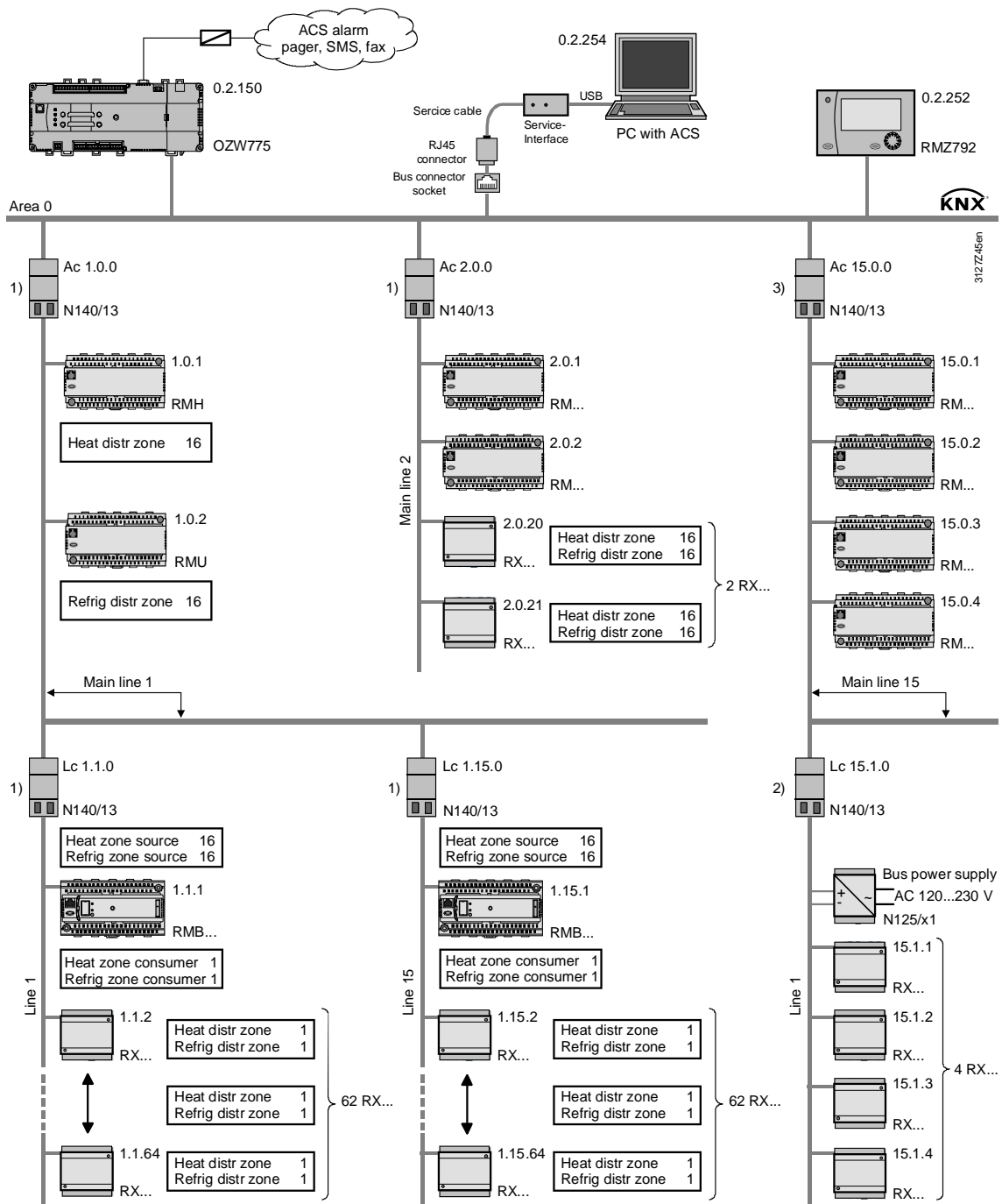

LTE filter table: 1) Normal (route), 2) Route all, 3) Block all

## 8.2.5 System time, alarms, and remote time adjustment

System time

The system time (time and date) is communicated in S-Mode and not affected by LTE filtering.

Alarms and remote time adjustment

Alarms and remote time adjustments are transmitted in LTE-Mode (LTE broadcast address). This address is listed in the predefined LTE filter table and therefore subject to LTE filtering.

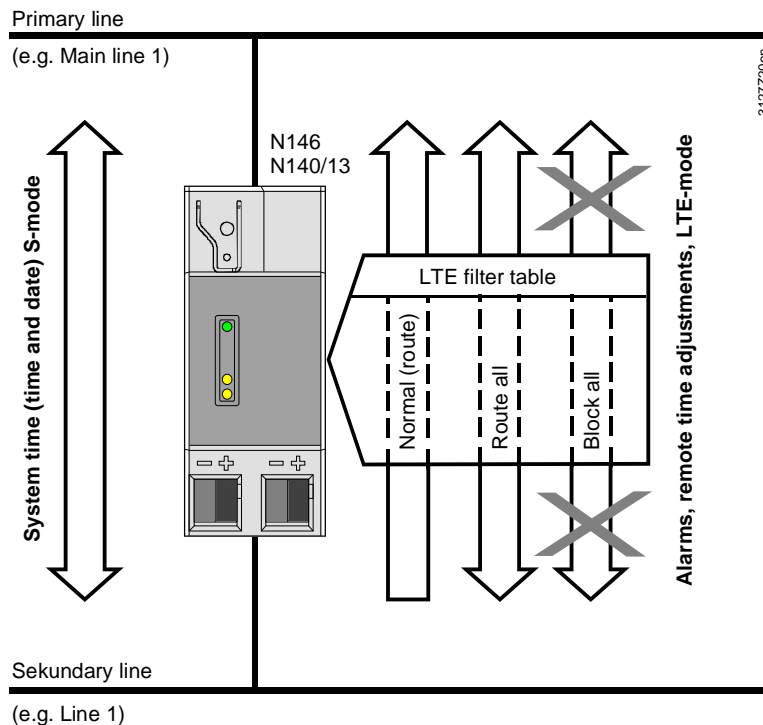

### Two-way and one-way communication

The diagram shows the following:

The system time (time and date) is always transmitted by devices on the primary line to devices on the secondary line and vice versa → two-way communication.

Normal (route)

If the filter is set to "Normal (route)" in the area/line couplers and IP routers, alarms and remote time adjustments are transmitted only from the secondary line to the primary line → one-way communication.

Route all

If "Route all" is set, alarms and remote time adjustments are transmitted from the secondary line to the primary line and vice versa → two-way communication.

Block all

"Block all" means that the transmission of alarms and remote time adjustments is blocked → no LTE telegram communications.

### Time synchronization

In a network with couplers and IP routers, only one RM... controller can function as time master (see Section 6.1.2).

The time can only be adjusted remotely via a time slave if the time master is located on the same line or on the next higher line.

## 8.3 Engineering large plants

---

<b>Engineering with ACS</b>	The ACS790 software is recommended to engineer large plants, as it can be used to set all necessary addresses and configuration values.
Addressing	<ol style="list-style-type: none"><li>1. Addressing of area/line couplers and IP router.</li><li>2. Set device addresses at bus devices.</li><li>3. Additional settings for the IP network in the IP router via ACS790 (see below).</li></ol>
Note	If the area/line couplers and IP routers are addressed before the bus devices, the bus devices are ready to receive the "area" and "line" components of the address.
Note	To keep communication to a minimum, filter setting "Normal (route)" should be retained.
<b>IP address assignment</b>	<p>IP routers are factory-set to obtain their IP address from a DHCP<sup>1)</sup> server. ACS allows for manual assignment of the IP address.</p> <p><sup>1)</sup> Dynamic Host Configuration Protocol. DHCP is a client-server protocol that reduces the time and effort required to assign IP addresses.</p>
<b>IP settings</b>	<p>Other IP settings in ACS:</p> <ul style="list-style-type: none"><li>• IP routing, multicast addresses</li><li>• IP subnet mask</li><li>• IP standard gateway</li></ul>

## Engineering with ETS

When using the ETS engineering tool, e.g. in plants with third-party devices, the ETS product database of Synco bus devices must be imported into ETS.

### Note especially the following when engineering with ETS:

- ETS does not allow access to the LTE filter table (to filter zone addresses).
- ETS allows access to the S-Mode filter table (to filter group addresses).
- Fixed group addresses are defined in the KNX standard for some system functions, including, e.g., group address 30/3/254 for the system time and 30/3/250 for fault information.
- Group addresses 30/3/254 and 30/3/250 are factory-set in the Synco bus devices.

## Notes

When downloading new group addresses into Synco bus devices, the group addresses 30/3/254 and 30/3/250 referred to above must be set up in the ETS tool and connected. Only then can the download be initiated.

Without group address 30/3/254 and a connection for the system time, the time between the Synco bus devices after the first download can no longer be synchronized.

If a different group address is used for the system time, this group address must be entered and downloaded to all devices with system time communication (master and all slaves).

It is not possible to set up group address 30/3/xxx (main group 30) in ETS with default values. However, it is possible to enable the setting of main groups > 15 via the Windows registry. Please address questions about the required entries for this purpose to your ETS supplier.

The special group addresses can also be downloaded via the HIT Info Center -> Product Overview -> Synco ([www.siemens.com/hit](http://www.siemens.com/hit)) and imported in ETS.

Empty page

# 9 Appendix

## 9.1 Faults and errors

Various events cause faults and errors which then trigger error messages. This document deals only with communication errors (see also the tables on the next page).

### Communication error.

Type of error	Examples
<ul style="list-style-type: none"><li>Failure</li></ul>	<ul style="list-style-type: none"><li>No bus power supply.</li><li>System time failure.</li></ul>
<ul style="list-style-type: none"><li>Setting errors</li></ul>	<ul style="list-style-type: none"><li>More than 1 system time master defined.</li><li>More than 1 room master defined in the same "geographical zone".</li><li>Address error (e.g. two bus devices with the same device address).</li></ul>

Device errors such as sensor errors, faults in the extension module, or plant faults such as fan overload, burner fault, dirty filters, frost conditions etc. are described in the basic documentation.

### 9.1.1 Fault status message bus

All fault status messages are distributed over the KNX bus. In this process, the fault with the highest priority or, in the case of equal priority, the oldest fault, can be displayed on the "Fault status signal bus" operating page (access via Service level).

■ Main menu > Faults > Fault status message bus

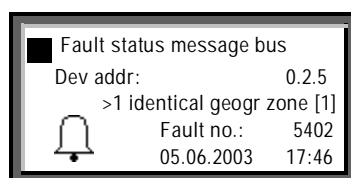

### Notes

The "Fault status message bus" operating page can be selected at all access levels.

The operating lines on the "Faults" operating page, namely "Faults current" and "Fault history" relate to the faults associated with that controller (i.e. not to faults from other devices transmitted over the KNX bus).

The faults are arranged in order of priority. However, "Fault 1" (the "Fault 1" line displayed on the RMZ790 and RMZ791 operator units or the "Fault 1" menu line in the ACS menu tree) and the highest-priority fault are not necessarily identical.

## 9.1.2 Communication error

---

The following is a list of errors associated with communication over the KNX bus (see also the listed sections in this document).

### Failure

Fault no.	Fault message on RMZ79x operator unit	Failure
5000	No bus power supply	No bus power supply.
5001	System time failure	System time failure (slave).
5101	Time swi fail pl 1	Time switch program failure (plant 1).
5111	Time swi fail pl 2	Time switch program failure (heating circuit 2).
5201	Hol/spec day failure	Failure holiday/special day program.
5301	DHW time swi fail	DHW time switch program failure.
5401	Room mast fail pl 1	Room master failure (plant 1).
5411	Room mast fail pl 2	Room master failure (heating circuit 2).

### Setting errors

Fault no.	Fault message on RMZ79x operator unit	Setting errors
6001	>1 id device address	More than one device with same device address.
5002	>1 clock time mast	More than one clock time master.
5102	>1 time switch pl 1	More than one time switch program active in same zone (plant 1).
5112	>1 time switch pl 2	More than one time switch program active in same zone (heating circuit 2).
5202	>1 hol/sp day prgm	More than one holiday/special day program active in the same day/special day zone.
5302	>1 DHW time switch	More than one time DHW switch program active in same zone.
5402	>1 geogr zone [1]	More than one controller operating as room master in the same geographical zone [1].
5412	>1 geogr zone [2]	More than one controller operating as room master in the same geographical zone (e.g. in RMH: Heating circuit 2).



## 9.2 Heating/cooling changeover

### Use

The **universal RMU7x0B controllers** are programmed with the new "H/C changeover" function block, which is used for changeover of the specified "Heating" or "Cooling" mode in **2-pipe systems**.

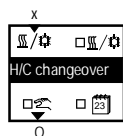

The specified "Heating" or "Cooling" mode can be generated in the controller itself, or received as a "Heating/cooling changeover signal" over the KNX bus.

The following methods of changeover can be programmed for the specified "Heating/Cooling" mode:

- Changeover via digital input, e.g. with manual switch or with a changeover thermostat in the flow (already an option with RMU7x0).
- Changeover via analog input, e.g. based on outside air temperature or flow temperature.
- Changeover based on the calendar (date): Configured in the "H/C Changeover" function block (calendar symbol selected).
- Changeover with operating mode selector. Configured in the "H/C Changeover" function block ("Hand" symbol selected).

### Effect of specified mode

The "Heating/Cooling" mode is not affected by the type of changeover. If several types of changeover are selected, the required operating mode is determined in the following order of priority:

1. Operating mode selector
2. H/C changeover input
3. Heating/cooling by calendar

The required "Heating/Cooling" mode is transmitted by the "changeover controller" to all other controllers in the heating distribution and refrigeration distribution zones.

In a hydraulic circuit, the "Heating/Cooling" mode can be defined in one location only. If several H/C changeover signals in the same distribution zone are distributed over the KNX bus, a fault message is generated.

### Note

If possible, the required "Heating/Cooling" changeover command should be activated in the primary controller or generator.

### Activate function

The "H/C changeover" function is activated by setting the operating line "2-pipe system heating/cooling" to "Yes".

### Configuration

 Main menu > Commissioning > Extra configuration > Heating/cooling ch'over

Operating line	Range	Factory setting
2-pipe heating/cooling system	No, yes.	No



## 9.2.2 Changeover via analog input

### Changeover source analog input AI

The outside temperature sensor is wired to universal input "x" (configured as analog input) of the "H/C changeover" function block in controller 1 (RMU7x0B). The release relay in controller 1 acts on heating/refrigeration generation. The heating/cooling changeover signal acts on all controllers (here, controllers 1 and 2) in the same heating/refrigeration distribution zone.

### Note

If an analog signal is the source of the H/C changeover, two limit values must be selected for changeover. For further information see basic documentation, manual P3150.

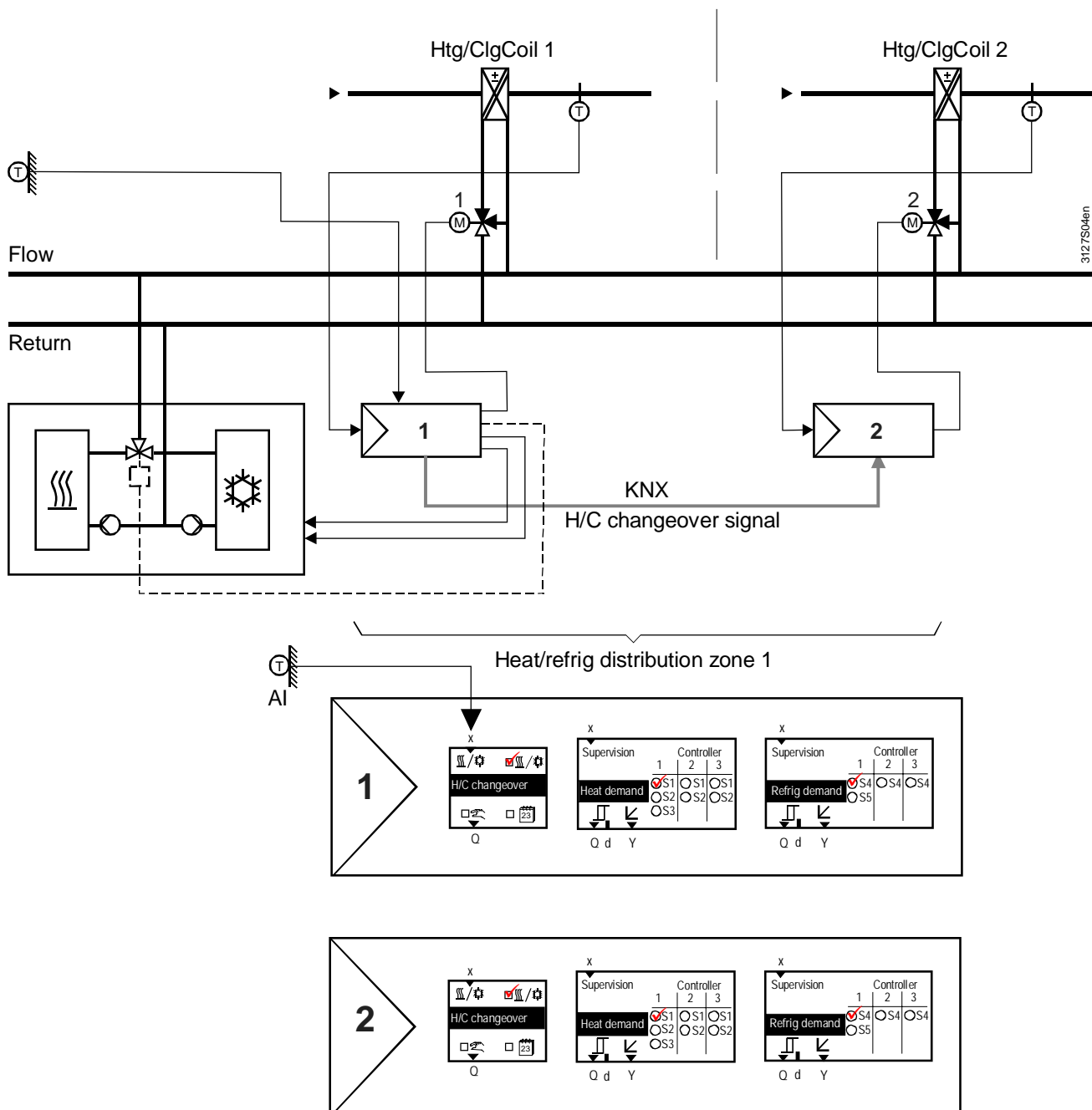

### 9.2.3 Changeover based on calendar

#### Changeover source calendar

Calendar-based changeover is configured in the "H/C changeover" function block (see the checkmark by the calendar symbol in the primary controller, RMU7x0B). The HC changeover relay in the primary controller acts on heating/refrigeration generation which is also controlled by the primary controller.

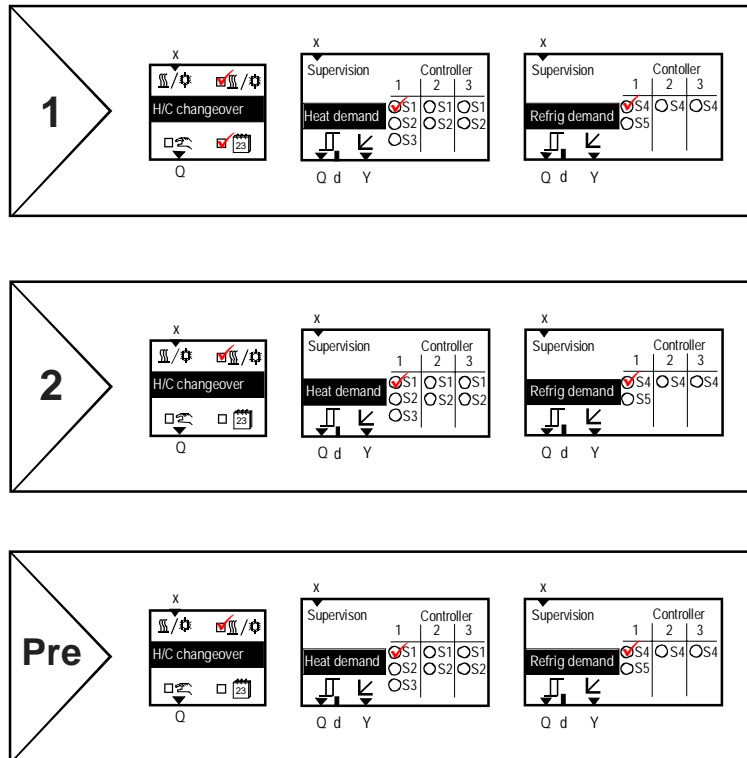
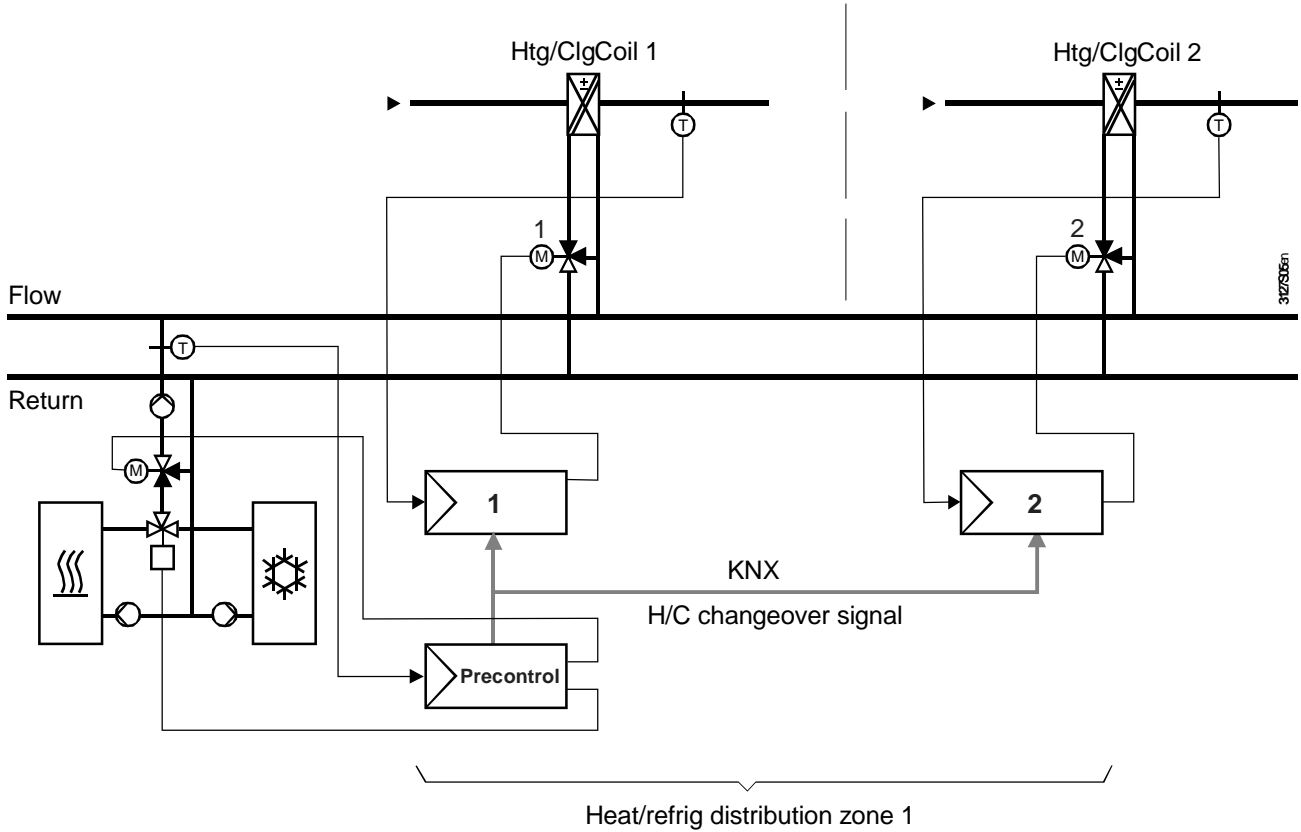

## Configuration

 Main menu > Commissioning > Extra configuration > Heating/cooling ch'over

Operating line	Range	Factory setting
Heating/cooling acc to calendar	No, yes.	No

## Setting values

 Main menu > Commissioning > Settings > Heating/cooling ch'over

Operating line	Range	Factory setting
Start date heating	01.01. - 31.12.	01.10.
Start date cooling	01.01. - 31.12.	01.05.

Changeover occurs on "Start date, heating" or "Start date, cooling".

## 9.2.4 H/C changeover relay and fault status messages

### Heating/cooling ch'over relay

If, instead of being transmitted over the bus, the H/C changeover signal is provided at a relay output, e.g. for switch control of a valve, or forwarding to a non-communicating device, the H/C changeover relay can be configured accordingly. See the notes on connecting the primary controller to the changeover valve.

## Configuration

 Main menu > Commissioning > Extra configuration > Heating/cooling ch'over

Operating line	Range	Factory setting
Heating/cooling ch'over relay	----, N.Q1, N.Q2,.../	----

## Current contact position

The current contact position (status) of the changeover relay can be displayed via the Service level.

 Main menu > Heating/cooling ch'over

Operating line	Current contact position (status)
Heating/cooling ch'over relay	Open (Off) Cooling / Closed (On): Heating

### Fault status messages

#### H/C changeover signal failure

In a 2-pipe system without H/C changeover signal on the KNX bus, the controller continues to use the last received value. If the signal never existed, "Heating" is used as default value.

#### Fault status message 5801

No.	Text	Effect
5801	H/C changeover signal failure	Non-urgent message; no acknowledgement required.

#### > 1 H/C changeover signal

If the "H/C changeover" in a 2-pipe system is configured so that it is initiated by calendar or operating mode selector, and if a changeover signal is received in one of the zones from another device, message ">1 heat/cool changeover signal" is transmitted.

#### Fault status message 5802

No.	Text	Effect
5802	>1 heat/cool changeover signal	Non-urgent message; must be acknowledged.

## 9.3 Room control combination function

### 9.3.1 Application examples

#### Introduction

The "Room control combination" function can be used to link two RM... controllers so that they operate with the same operating mode and the same room setpoint. The two controllers must belong to the same "Geographical zone (apartm.)".

If one of the two controllers is an RMU controller, this controller always becomes the "Room controller master". If two RMU or RMH controllers are used in the same application, one must be defined as the master and the other as a slave.

#### Application example 1

##### Radiator and floor heating

The "Room control combination" function, for example, allows for e.g. heating a room with radiator heating and floor heating. Exchanging room temperature and operating mode over the KNX bus allows for a joint control strategy with the following aim:

- Optimum control (e.g. boost enabled at the correct time).
- Same room operating mode for both controllers (time switch and holiday/special day program, manual override).
- Adjustable room influence.

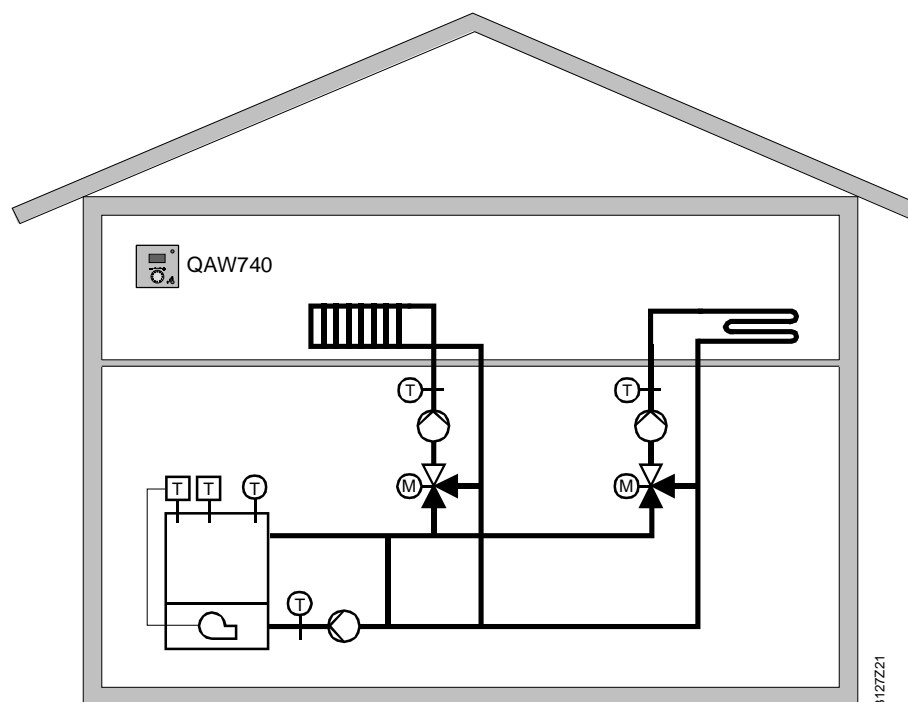

Controller 1 and 2,  
both type RMH

Two RMH controller are required for application "Radiator and floor heating in the same room". Controller 1 is defined as master room controller, and Controller 2 as slave room controller.

The first step is to set the zone addresses of the "Geographical zone (apartm.)" in the controllers.

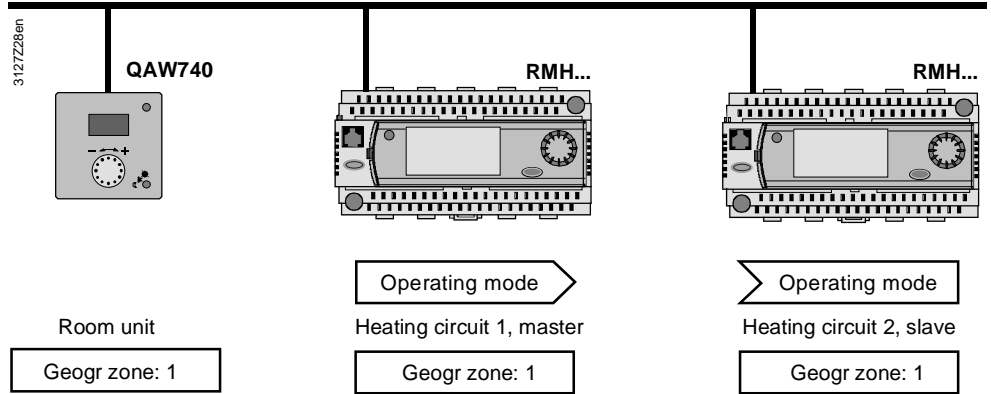

Set room control combination

- Room control combination **Master**  
Transmits room setpoint and operating mode.
- Room control combination **Slave, external setpoint**  
Receives room setpoint and operating mode.
- Room control combination **Slave, internal setpoint**  
Retains its own room setpoint as valid, but adopts the operating mode from the master.

**Application example 2**

**Room control combinations featuring multiple ventilation controllers**

When a space is controlled by several ventilation controllers, e.g. two RMU7x0B controllers (they must be RMU7x0B controllers) controlling the temperature in a warehouse, the controllers can exchange information such as room temperature, operating mode, and setpoint over the KNX bus.

Note

With this room control combination, one ventilation controller must be set as the master and all the others as slaves.

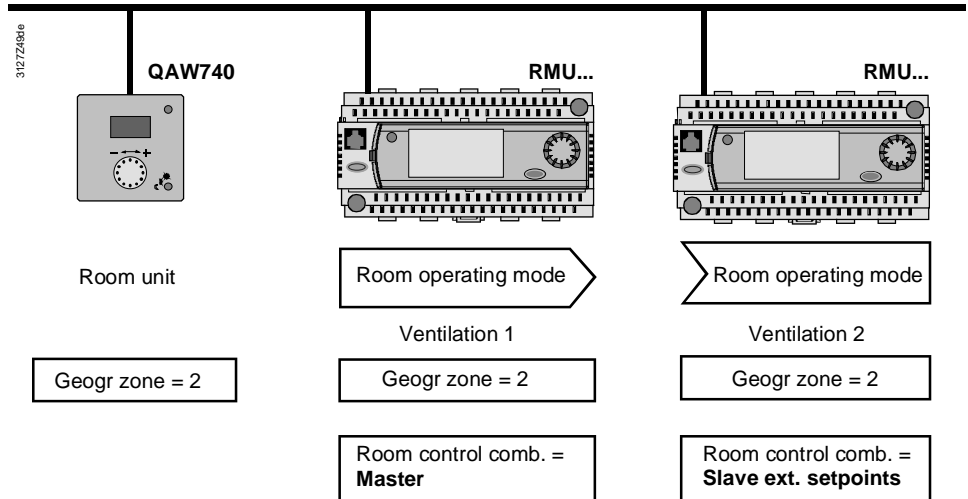

Slave ventilation controller settings

Within the room control combination, the slave ventilation controller operates with the same operating mode as the master.  
The slave controllers can use either the same setpoints as the master, or individual setpoints.

Control strategy	Room control combination	Effect
<ul style="list-style-type: none"> <li>• Same room operating mode</li> <li>• Shared setpoints</li> </ul>	Slave external setpoint	<p>The slave ventilation controller shares the same setpoint as the master:</p> <ul style="list-style-type: none"> <li>☀ Comfort heating setpoint</li> <li>🌡 Pre-Comfort heating setpoint</li> <li>🏠 Economy heating setpoint</li> </ul> <p>The setpoints cannot be set in the slave ventilation controllers. Any setpoint adjustments required must be made in the master ventilation controller.</p>
<ul style="list-style-type: none"> <li>• Same room operating mode</li> <li>• Individual setpoints</li> </ul>	Slave internal setpoint	The slave ventilation controller operates with its own setpoints.

### Application example 3 Room with floor heating and ventilation

Another application of the "Room control combination" is a room with floor heating and a ventilation system. Exchanging the relevant process values over the KNX bus allows for a common control strategy with the following aim:

- Optimum control, heating or cooling.
- The same room operating mode for both controllers (time switch and holiday/special day program, manual override).
- Automatische Umschaltung der Lüftungsregelung  
(Winter: Constant supply air temperature control, own setpoints).  
(Summer: Room/supply air cascade control).

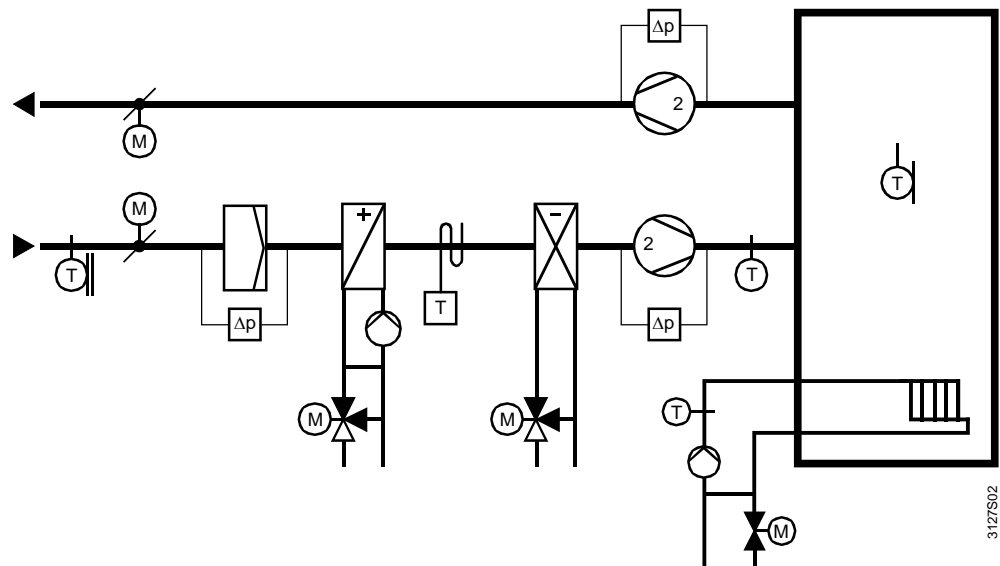



Ventilation,  
master controller RMU

The ventilation settings for an RMU master controller programmed with plant type A03 (ADC001 MU1 HQ) are carried out under:

...> Commissioning > Communication > Room  
 → Geogr zone (ap): **3**

...> Commissioning > Settings > Controller 1 > Cascade controller  
 → Control strategy: **Alternating**

Heating,  
slave controller, RMH

The heating settings for an RMH slave controller programmed with basic type 0-2 are carried out under:

...> Commissioning > Communication > Room 1  
 → Geogr zone (ap): **3**

...> Commissioning > Extra configuration > Heating circuit 1 > Functions  
 → Room control comb: **Ext setp** (Slave internal setpoint)

...> Commissioning > Settings > Heating circuit 1 > Optimizations/influences  
 → Room influence: **0**

Note

If the same room is controlled by an RMU ventilation controller and an RMH heating controller, the RMU ventilation controller in this room control combination must be set to "Master".

Zone addressing

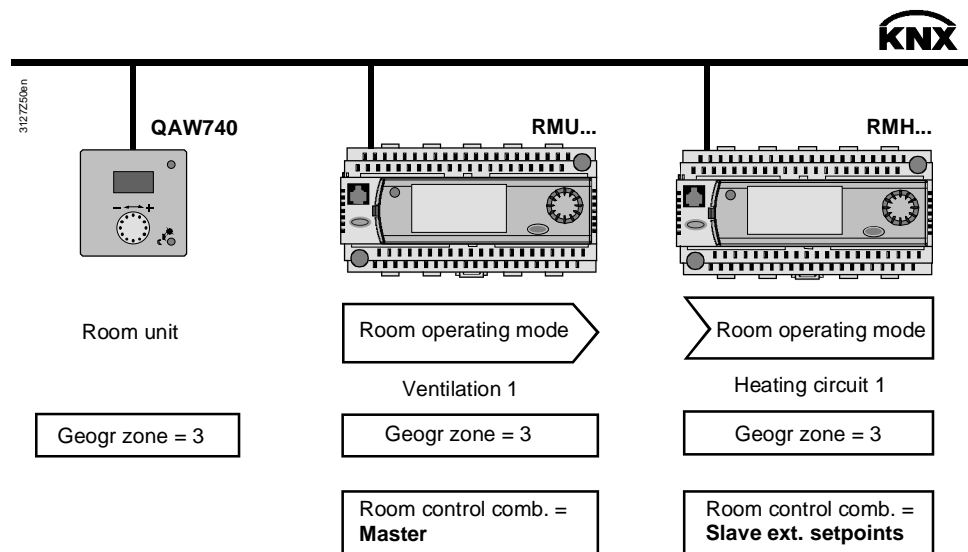

Heating setpoints

The heating setpoints:

- ☼ Comfort heating setpoint
- 🌡️ Pre-Comfort heating setpoint
- 🏠 Economy heating setpoint

are transmitted by the ventilation controller to the heating controller over the KNX bus. The existing setpoints in the heating controller are overwritten.

Both controllers operate with the same heating setpoint. If a heating controller setpoint needs to be adjusted, it must be changed in the ventilation controller (master).

## 9.4 Application with zones

The following assumes a commercial building with a ground floor and four upper floors. On the ground floor is a retail outlet with a showroom. Each of the upper floors has four offices, three laboratories, and one IT room (server, printer, fax etc.) Access to the upper floors is via a staircase and service elevator. There are various alternatives for dividing this commercial building into operating zones.

Variant 1:

The commercial building is occupied by only one tenant. In this case, the building can easily be divided into 5 room groups or "geographical zone (apartm.)".

Ground floor	→ Geographical zone (apartm.)=1 (Room group 1)
Stairwell	→ Geographical zone (apartm.)=2 (Room group 2)
All IT rooms Floors 1 - 4	→ Geographical zone (apartm.)=3 (Room group 3)
All offices Floors 1 - 4	→ Geographical zone (apartm.)=4 (Room group 4)
All labs Floors 1 - 4	→ Geographical zone (apartm.)=5 (Room group 5)

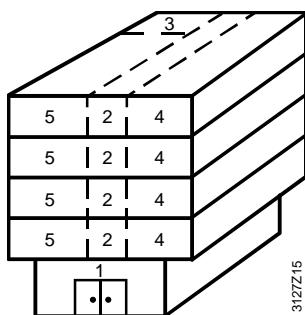

Variant 2:

There are five tenants in the commercial building. Tenant 1 occupies the ground floor, and tenants 2 to 5 each occupy one of the four upper floors. All tenants have their own requirements for their offices and labs. From a technical perspective, this requires the building to be divided into eleven "geographical zone (apartm.)" or room groups.

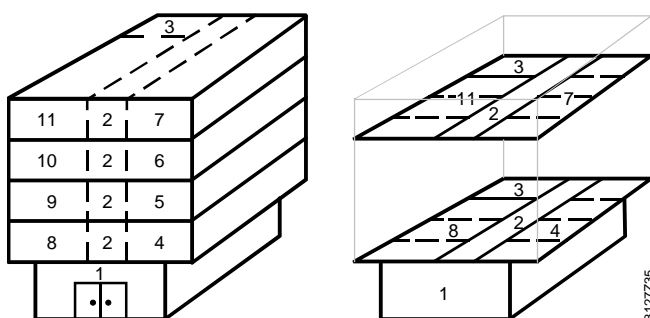

## 9.4.1 Additional zones in the RXB/RXL room controller

The RXB/RXL room controllers have not only the "Geographical zone (apartment)" zone category, but also the "Geographical zone (room)" and "Geographical zone (subzone)".

For applications with RXB and RXL room controllers, use only the "Geographical zone (apartment)" and "Geographical zone (room)" categories. For Variant 2 above, these two zone categories can be used for zone addressing as follows:

Variant 2 RXB/RXL zoning

Ground floor		→ Geographical zone (apartment)=1
Stairwell		→ Geographical zone (apartment)=2
All IT rooms		→ Geographical zone (apartment)=3
Office 1	1. floor	→ Geographical zone (apartment).(room)=4.1
Office 2	1. floor	→ Geographical zone (apartment).(room)=4.2
Office 3	1. floor	→ Geographical zone (apartment).(room)=4.3
Office 4	1. floor	→ Geographical zone (apartment).(room)=4.4
Office 1	2. floor	→ Geographical zone (apartment).(room)=5.1
...		
Office 4	4. floor	→ Geographical zone (apartment).(room)=7.4
Laboratory 1	1. floor	→ Geographical zone (apartment).(room)=8.1
Laboratory 2	1. floor	→ Geographical zone (apartment).(room)=8.2
Laboratory 3	1. floor	→ Geographical zone (apartment).(room)=8.3
Laboratory 1	2. floor	→ Geographical zone (apartment).(room)=9.1
...		
Laboratory 3	4. floor	→ Geographical zone (apartment).(room)=11.3

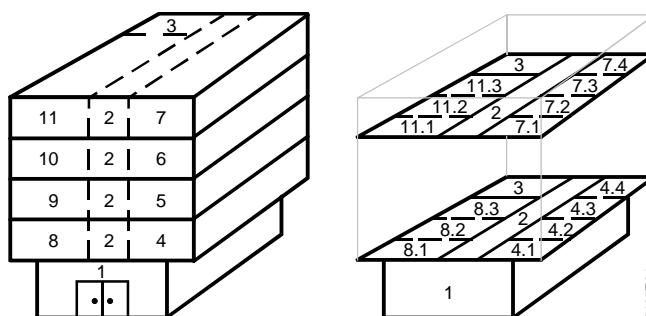

Notes

Extending addressing by the "geographical zone (room)" results in individual room control with RXB/RXL room controllers. This allows for individual manual intervention, e.g. adjustment of the room setpoint in every room (in our example in every office and lab).

For additional division of the geographical zone (room), the RXB/RXL room controller offers the geographical zone (subzone). This subzone can be valuable in lighting installations, to subdivide a "Geographical zone (room)" for example into the two subzones "lighting along window" and "lighting along hallway" (e.g. EIB applications). For HVAC applications, the setting subzone =1 can be left unchanged.

The supplementary labels "(Apartment)", "(Room)" and "(Subzone)" are predefined by KNX, where "Apartment" does not denote an actual apartment.

## 9.5 Supply chains

The applications in the Synco 700 type RMU/RMH controllers consist of HVAC functional units. These functional units are based on the supply chains in buildings.

### Supply chain configuration

A supply chain consists of at least one producer and one consumer, but often producer, distributor, and consumer.

1. A producer with one distributor and one consumer.
2. One producer with two distributors in series and one consumer.
3. Several producers, distributors, and consumers in parallel.

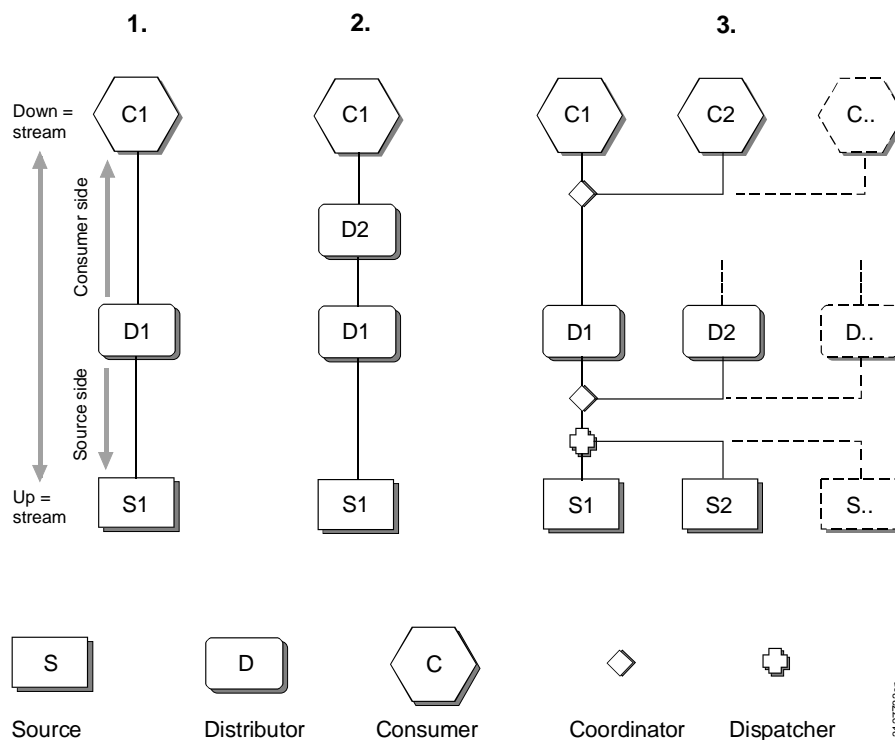

The "coordinator" and "dispatcher" are defined as logical elements in the supply chain. Their role is as follows:

- The coordinator collates the demand signals from all downstream links in the chain, and delivers the resulting demand signal to the link upstream. The coordinator also reports the operational status of the upstream links to the downstream link.
- From the resulting demand signals of the consumers, the dispatcher determines which generators, and how many, must be enabled.

Supply chain outputs and inputs

The above illustrations of supply chains show the following:

- Consumer has one output to the distributor.
- Producer has one input from the distributor.

Supply/demand

- **Consumer** transmits heating/refrig. **demand** to the upstream distributor
- **Producer** receives heating/refrig. **demand** from the upstream distributor.

**HVAC application architecture**

For a better understanding of the distribution zones for heating and refrigeration, the following extract is reproduced from document CM110057 "HVAC application architecture".

**Supply chains for a room**

Different consumption needs such as *heating*, *refrigeration*, and *fresh air* can be defined for a room.

*Heating*

The *hot water* supply chain is available for *heating*. The medium *hot water* is generated in the hot water supply system and distributed via a heating circuit; demand-based *heat* is then supplied to the room via a heating surface. If the heat transfer medium is air, this involves primary and secondary air handling.

**Refrigeration**

The *refrigeration* requirement is met by the *chilled water* supply chain. The medium *chilled water* is generated in the chilled water supply system and distributed via a cooling circuit; *refrigeration* is then supplied to the room according to demand by means of a *cooling surface*. When the cooling-energy transfer medium is air, this involves both primary and secondary air handling.

*Outside air*

The *outside air* is provided by the *air* supply chain. The medium is treated in the air handling plant, distributed via the ducting, adapted if necessary by an air retreatment system to the requirements in the room, and discharged into the room via air diffusers.

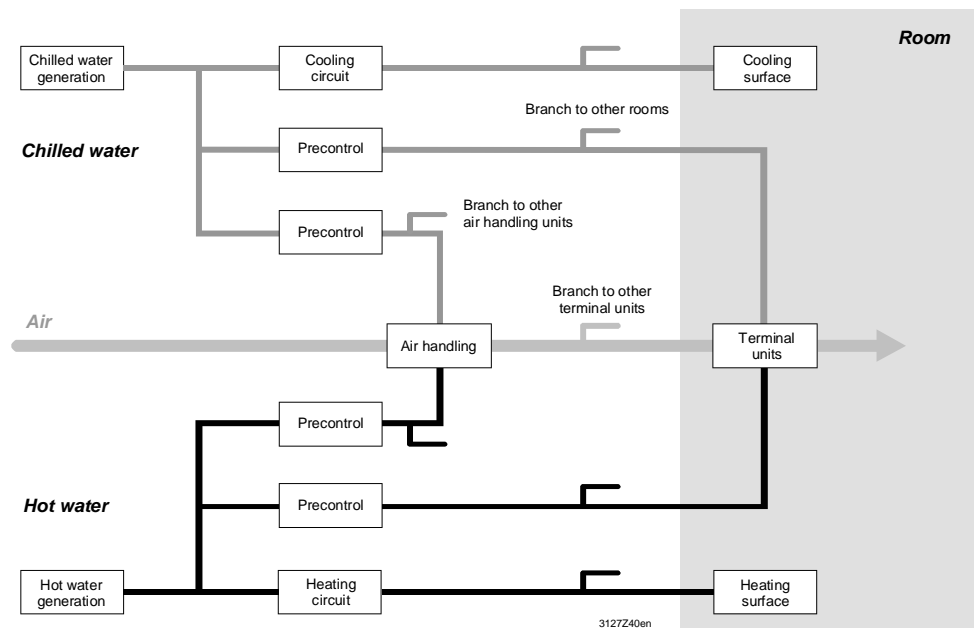

**Plant**

Essentially, a plant comprises partial plant, aggregates and components, but in principle, these can equally be expressed in terms of a supply chain with the following links: energy generator, distribution (primary controller, heating circuit) and energy consumer (radiator).

**Operator intervention**

For each link in the supply chain, the HMI can be used for commands which affect the plant (the process) via the relevant functional unit and the automation system.

**Functional units**

The functional units correspond to the software mappings of the links in the chain and the plant elements. They contain all control, monitoring, and limiting functions required for operation.

## Example

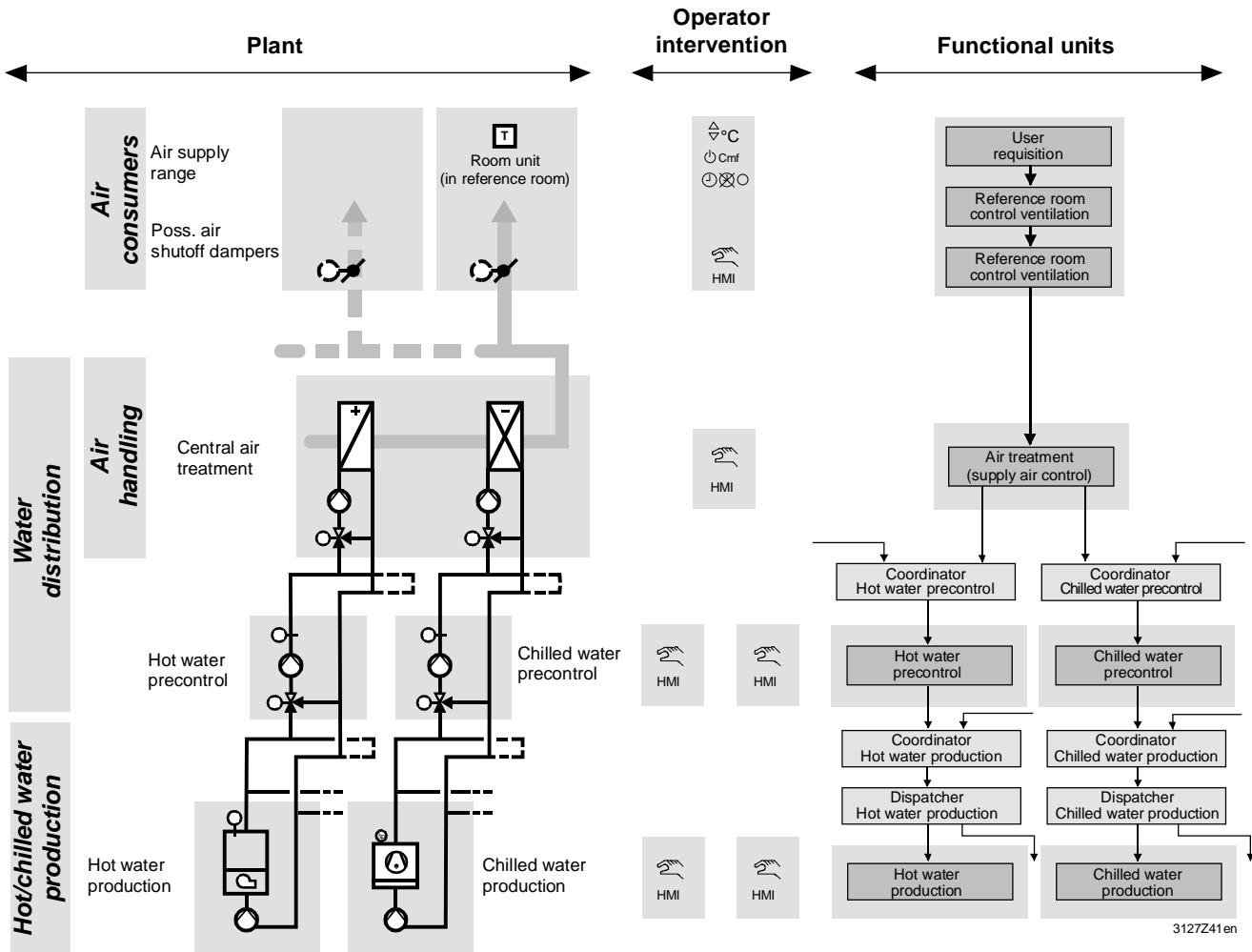

### 9.5.1 Data exchange in LTE-Mode

#### Data exchange

The control chains and circuits in an HVAC plant consist of data points. The data points or their process values are programmed in function blocks to create the technical functions in the HVAC process.

To exchange process values between the Synco devices within a zone, it is sufficient simply to allocate a common zone address to those devices.

#### LTE-Mode

In LTE-Mode (LTE = Logical Tag Extended), the communication bindings between data points are created by means of logical tags. This is the equivalent of the zone addresses in Synco.

LTE-Mode does not require time-consuming engineering to create the communication bindings to exchange process values.

## 9.6 Update process values

---

### Example outside air temperature

Process values such as the outside air temperature can be transmitted to other bus devices via distribution zones. As the process values rarely are constant, transmitting every minimal change in value would result in heavy traffic on the bus.

### COV = Change of value

The Synco controller updates the process values (in our example the outside air temperature) when it changes by a fixed, predefined differential ("delta value"). Thus, the fluctuations in the outside air temperature are added up until the delta value is reached, and only then is the new value transmitted or updated. The term COV ("change of value") is applied to process values updated in this way.

### Minimum repetition time

If a process value fluctuates widely and the delta value is reached before the "minimum repetition time" of 10 seconds has expired, there is a delay of 10 seconds before the process value is updated.

### Heartbeat

With a constant outside air temperature, it may take a long time until the delta value is reached. For this reason, the outside air temperature is updated every 15 minutes. This is referred to as a "heartbeat".

### Fault status message

If the outside air temperature is still not transmitted after the first 15-minute delay, the controller waits another 15 minutes plus 1 minute (i.e. a total of 31 minutes since the last update) to transmit a fault status message.

Depending on the application, the controller now continues to operate with the preset values, e.g. if the outside air temperature sensor is faulty, the flow temperature is controlled as if the outside air temperature were 0 °C. Certain functions are also disabled, e.g. there is no summer/winter compensation.

### Important notes

- Process values are not updated if the bus device is set to device address 255.
- Process values are not updated when the controller is in commissioning mode, i.e. if the "Commissioning" operating page is selected directly or as part of a sequence.

## 9.7 Lightning and overvoltage protection, EMC

### 9.7.1 Lightning protection

#### Bibliography

The notes on lightning and overvoltage protection are based on the "KNX Handbook": Volume 4, Part 4 "Installation Safety Requirements".

#### Lightning protection measures

- The KNX bus must be included in the safety measures for the mains network.
- Lightning protection systems must be engineered and installed by specialists who understand and comply with the relevant regulations and standards.

#### External lightning protection

External lightning protection consists of permanently active lightning conductors (an air-termination system, a down conduction system and an earth termination system).

External lightning protection is required for buildings where lightning strikes are common due to the location, type of building or its use, or where the consequences may be severe. Lightning protection is mandatory for public buildings and buildings with assembly rooms. The necessity of erecting a lightning protection system is determined by the building codes of the related country.

#### Internal lightning protection

Internal lightning protection is based on consistent equipotential bonding for lightning protection, i.e. all metal components such as water, heating and gas pipes, metal walls etc. must be connected to the equipotential bonding rail. Internal lightning protection is required in buildings with electronic devices susceptible to transient surges. This protection consists of measures to counter the effect of the lightning current and its electric and magnetic fields on metal and electrical conductors and equipment.

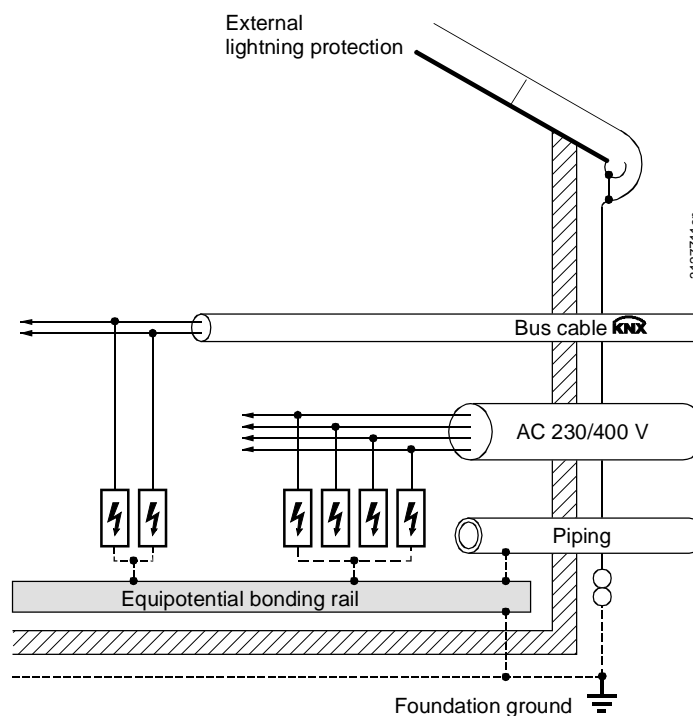

Figure: Lightning equipotential bonding (primary protection)



**Engineering of lightning protection equipment**

VDI 6004, Sheet 2, Edition July 2007, "Protection of building services - Lightning protection systems and surge protection" applies.

If lightning protection is required in a building, the active cores (see figure on previous page) must be connected with lightning arresters. This is also recommended in the following cases, for example, if:

- The building is connected to a low voltage overhead cable.
- The construction of the building includes metal parts which can be struck by lightning, e.g. metal chimneys or aerials
- There is another building with a lightning protection system in the vicinity.

**Note**

During engineering, selection of the lightning arrester must be coordinated with overvoltage protection equipment (note the information supplied by the manufacturers on the use of their products).

**Lightning arresters for primary protection**

Lightning arresters can discharge high-energy lightning current repeatedly without damage. They are installed in the AC 230/400 V mains network and KNX network.

**230/400 V mains network**

Lightning arrester (Class B) for the AC 230/400 V mains network:

- Nominal leakage current of at least 10 kA (10/350  $\mu$ s)
- Protection level < 4 kV

**KNX network**

Lightning arrester for the KNX network

- Nominal leakage current of at least 1 kA (10/350  $\mu$ s)
- Protection level < 4 kV

**Routing cables between buildings**

**Variant 1 with lightning arresters**

When routing cables between buildings, lightning arresters must be installed where the bus cable enters the building. They must be connected to the nearest equipotential bonding point.

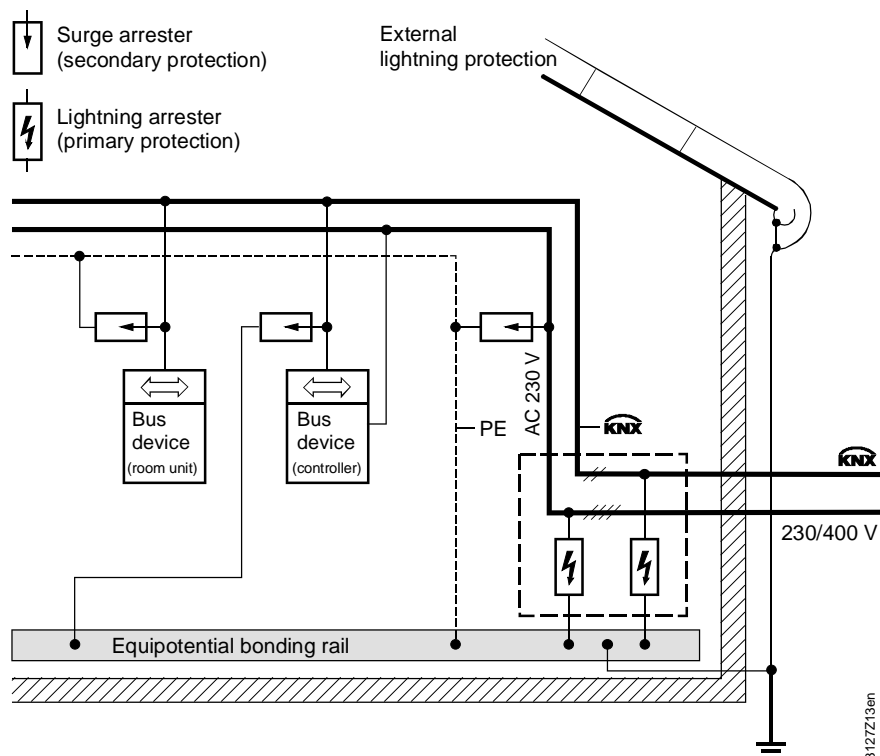

## Routing cables between buildings

### Variant 2 with surge arresters

With Alternative 2, the bus cable is protected with surge arresters and routed in a metal conduit or duct which is part of the equipotential bonding system.

The minimum cross-section of the conduit or duct must be sufficient to allow a substantial part of the lightning current to pass across it (min. cross-section: Cu 16 mm<sup>2</sup>, Al 25 mm<sup>2</sup>, Fe 50 mm<sup>2</sup>).

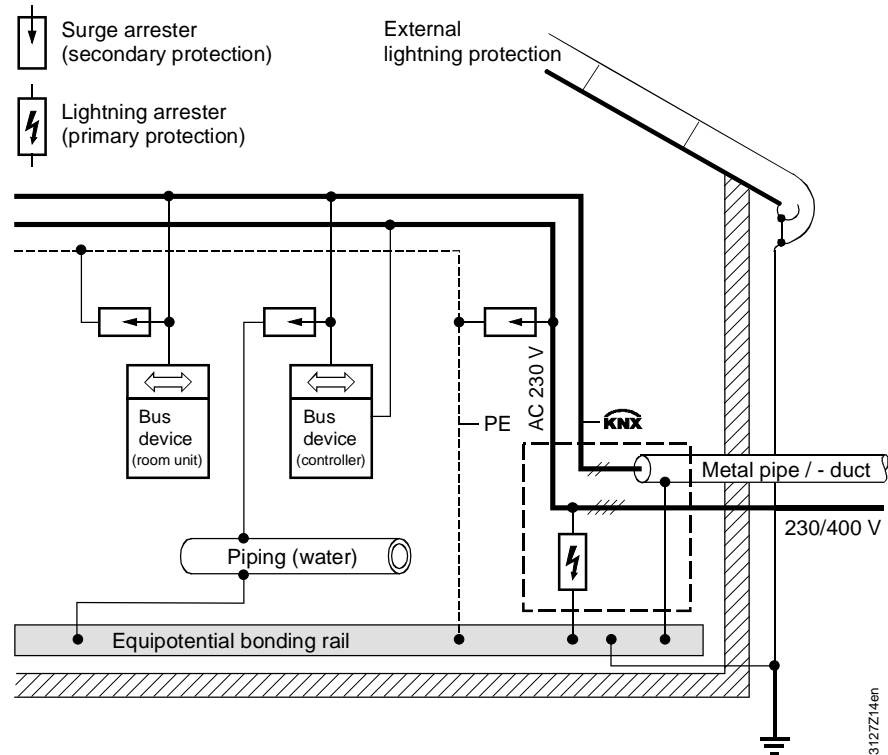

### Note

With Variants 1 and 2, a surge arrester must be installed as secondary on the bus device closest to the entry to the building. In relation to the bus cable length, the bus device should be installed some meters away from the lightning arrester, so that the surge arrester is not also partly responsible for primary protection.

## 9.7.2 Overvoltage protection

---

### Overvoltage protection, secondary protection

Overvoltage protection acts as secondary protection. Surge protectors are installed in the AC 230/400 V mains network and in the KNX network.

AC 230/400 V mains network

Surge arrester (Class B) for the AC 230/400 V mains network:

- Nominal discharge capacity of at least 5 kA (8/20  $\mu$ s)
- Protection level < 2 kV
- If varistors are used, they must be thermally monitored, and provided with insulating equipment.

KNX network

Surge arresters for the KNX network

- Nominal discharge capacity of at least 5 kA (8/20  $\mu$ s)
- Protection level < 2 kV
- The surge arrester must be matched to the KNX (TP1) levels.

### Effect of surge protectors

The surge protector protects the bus devices from overvoltages (transient surge voltages) which can be picked up by the bus cables. If the protective effect is damaged (e.g. by exceeding the permitted number of surge arresters), this results in a bus fault (bus low resistance). Note that no message is generated by this bus fault. Faulty surge arresters must be replaced immediately.

Note

Using surge arresters can improve the interference immunity of a KNX (TP1) network regardless of any overvoltage protection measures in conjunction with lightning protection.

### Surge arresters in bus terminal technology

Surge arresters normally have the same dimensions as bus connection terminals. However, the surge arresters can be distinguished by their color (blue) and the additional earth conductor. Where surge arresters are used instead of bus terminals, they must be connected to the nearest grounding point (e.g. protective conductor).

Surge arresters (manufacturer: Dehn) are available from Siemens as off-the-shelf components in bus terminal format.

- Overvoltage protection      Order no. 5WG1 190-8AD01

During engineering, make sure surge arresters can be installed, and that there is a connection point for them.

### 9.7.3 Overvoltages in loops

Loops are frequently the cause of electromagnetic interference (EMI) and surges resulting from lightning strikes. Loops occur when two independent networks (e.g. the KNX network and the AC 230 V mains network) are connected to one bus device.

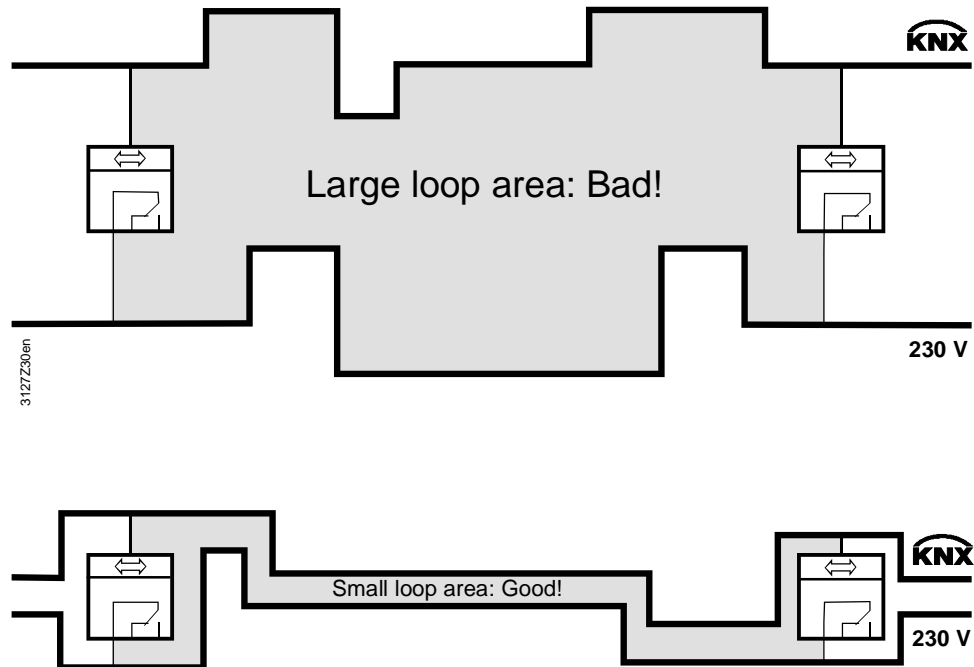

#### Avoid loops

Lightning can generate powerful surge voltages in loops, which cause short circuits in devices and damage electronic components irreparably.

It is important at the outset of engineering to avoid loops where possible, or to keep the extent of any loops (the "loop area") as small as possible. The formation of loops must be considered in relation to the entire installation and all conductive components must be taken into account, because the significant aspect of a loop is its overall area.

Note also:

- Bus and mains voltage conductors (power cables) must be routed as close together as possible. This also applies to earthed components, if they are in contact with the bus devices during normal operation.
- The distance between conductor ends, earthed components and other conductor ends should be as great as possible.
- Maintain an adequate distance from the lightning protection system (e.g. from arresters).

## 9.7.4 EMC protection management

---

Buildings with computer centers require EMC protection management in addition to lightning and overvoltage protection.

If a KNX network is installed in a building of this type, it must be part of the EMC protection management. The EMC protection arrangements must be agreed in detail with the person responsible for EMC protection management.

# Index

---

...	44	Definition of terms .....	6
<b>1</b>		Design engineering procedure.....	15
10BaseT .....	51	Device address .....	13
<b>A</b>		Device address and device name .....	29
Abbreviations.....	7	Device range Synco 700, Synco living, RXB/RXL, RDG, RDF, RDU.....	8
Access levels.....	26	Device types.....	9
ACS790 software .....	33	Devices with a bus power supply .....	17
Address devices with RMZ operator units.....	32	Devices without bus power supply .....	18
Address zones with RMZ operator units .....	46	DHCP server .....	60
Alarms and remote time adjustment.....	59	Distributed bus power .....	17
Application with zones .....	74	Distributor.....	76
Area 0.....	11	<b>E</b>	
Area line 0 .....	11	E-characteristic .....	17
Area/line address.....	11	EMC protection management .....	85
Area/line couplers.....	14	Engineering.....	15
Areas 1...15 .....	11	Engineering large plants.....	60
Assign device names .....	30	Engineering with ACS.....	60
<b>B</b>		Engineering with ETS.....	61
Basic communication settings.....	35	Ethernet 10 Mbps .....	51
Block all.....	54	Ethernet cable, crossed.....	52
Bus access method .....	6	Ethernet cable, straight.....	52
Bus cable.....	6	<b>F</b>	
Bus load number E .....	17	Factory settings.....	28
Bus topologies and distances.....	21	Fault status message bus.....	63
<b>C</b>		Faults and errors, communication.....	63
Cable length .....	22	Filter settings.....	54
Cat5 cable .....	51	Filtering, communication areas .....	56
Central bus power supply.....	20	Filtering, zone addresses.....	56
Central communication units OZW77x .....	9	<b>G</b>	
Change time and date.....	36	Geographical zone (apartment) .....	41
Changeover based on calendar .....	68	Geographical zone (room).....	75
Changeover via analog input.....	67	Geographical zone (subzone).....	75
Changeover via digital input.....	66	<b>H</b>	
Clock time operation .....	35	H/C changeover relay and fault status messages.....	69
Commissioning with RMZ operator units .....	26	Heating/cooling changeover .....	65
Commissioning, points to check.....	25	<b>I</b>	
Communication error .....	64	Individual address .....	12
Communication of process values.....	40	IP address DHCP .....	60
Consumer.....	76	IP address, manual.....	60
CSMA/CA.....	6	IP network administrator .....	51
<b>D</b>		IP router as area coupler .....	53
Data points .....	7	IP router as coupler to IP network.....	51
Default "----" in series B devices.....	42	IP routers .....	14
Default values.....	28	IP routers to link worlds .....	53
		IP settings with ACS .....	60

<b>K</b>			
KNX bus .....	6	Power supply unit PSU .....	20
KNX configuration mode .....	10	Predefined LTE filter table.....	55
KNX Logo .....	10	Producer .....	76
KNX network.....	11	Product markings .....	10
KNX transmission medium .....	10		
<b>L</b>		<b>R</b>	
Large plants, engineering.....	60	Read area, line and device address.....	29
Large plants, engineering and commissioning .....	47	Remote reset of fault .....	38
Large plants, network topologies .....	48	RMB795 central control unit as collector .....	58
Lightning protection.....	80	Room control combination .....	70
Lines 1...15 .....	11	Room thermostats RDx.....	9
LTE filter table.....	54	Route all.....	54
LTE filtering settings.....	54	RXB/RXL room controllers.....	9
LTE telegrams.....	54		
LTE telegrams via couplers and IP routers .....	57	<b>S</b>	
LTE-Mode.....	6	Service tool OCI700.1 .....	33
		Set time slave remotely .....	36
<b>M</b>		S-Mode .....	7
Main lines 1...15 .....	11	Specified distances.....	22
Multiple connections .....	52	Subnetwork .....	12
		Supply chains in buildings.....	76
<b>N</b>		Switch box.....	52
Network address.....	12	Switching Heating/cooling.....	65
Network with RX... room controllers.....	58	Synco 700 RM...controllers .....	9
Normal (route) .....	54	Synco bus devices.....	9
Number of bus devices .....	16	Synco zoning.....	39
		System time .....	59
<b>O</b>			
OCI700 service interface.....	33	<b>T</b>	
One-way communication.....	59	Time synchronization.....	59
Overvoltage protection.....	83	Timer function QAW740.....	37
		Two-way communication .....	59
<b>P</b>			
Physical address.....	12	<b>U</b>	
Point-to-point connection .....	52	Update process values .....	79
Power consumption of bus devices .....	19		
		<b>Z</b>	
		Zone adresse with QAW740 .....	46

Siemens Switzerland Ltd.  
Sektor Infrastructure & Cities  
Building Technologies Division  
Gubelstrasse 22  
6301 Zug  
Switzerland  
Tel. +41 41-724 24 24  
[www.siemens.com/sbt](http://www.siemens.com/sbt)

© 2003-2013 Siemens Switzerland Ltd.  
Subject to change