

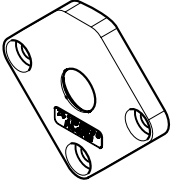

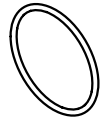

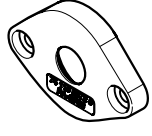



Lieferumfang/Included in delivery/Volume de livraison:

	1x	Dichtungshalter/Cover/ Couvercle (Frontgehäuse/Front housing/Front de boîtier)		1x	O-Ring/Joint torique (36 x 2 NBR, Shore A 70)
	1x	Dichtungshalter/Cover/ Couvercle (Gehäuseunterteil/Bottom part/Partie inférieure du boîtier)		1x	O-Ring/Joint torique (27 x 2 NBR, Shore A 70)
	3x	Schraube/Screw/Vis M5x10		1x	O-Ring/Joint torique (14 x 2 NBR, Shore A 70)
	2x	Schraube/Screw/Vis M4x10 (selbstfurchend/thread forming/auto-taraudeuse)		1x	O-Ring/Joint torique (12.1 x 1.6 NBR, Shore A 70)
	1x	Fettpäckchen/Grease pack/Petit sac de graisse		1x	Passscheibe/Washer/Rondelle d'ajustage (DIN 988 12 x 22 x 0.5)

1

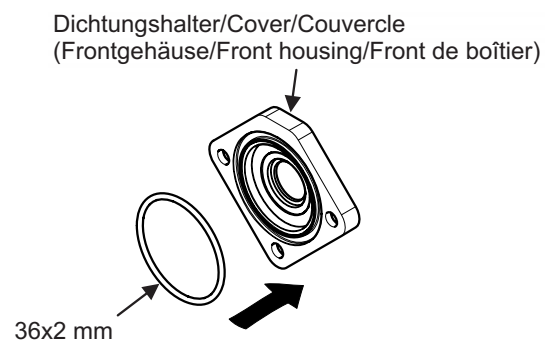
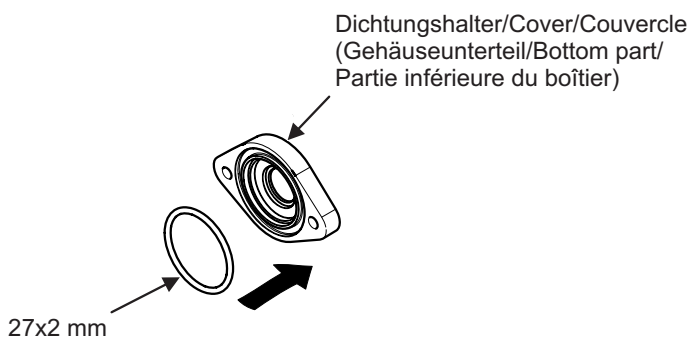

2

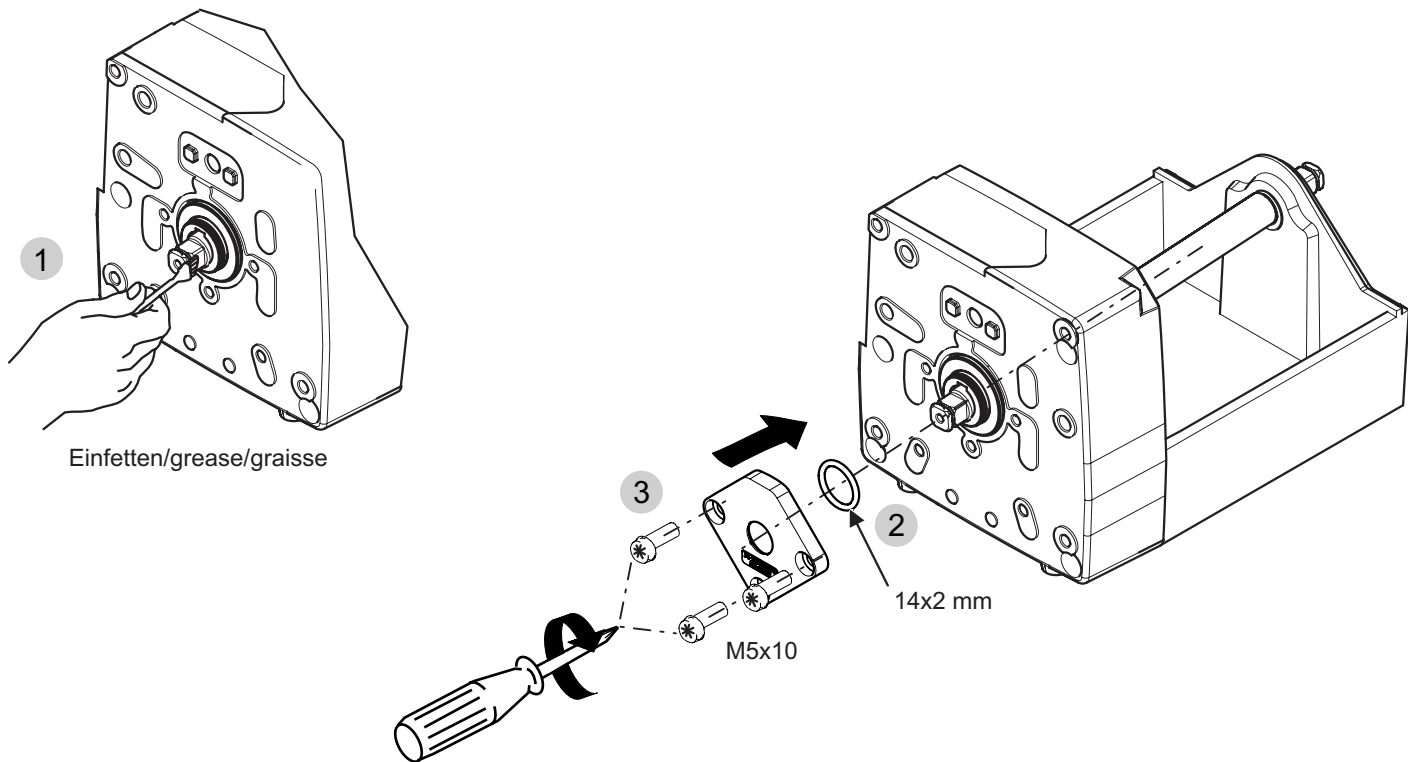

3

