



Self-learning room temperature controller

REA23M

Boiler control with OpenTherm Plus interface

- **Straightforward, self-explanatory menu selection via setting knob**
- **Permanent self-learning, adaptive control providing PID mode**
- **Choice of operating modes:**
 - Automatic with maximum 3 heating periods, continuous comfort mode, continuous economy mode, frost protection with one 24-hour operating mode with one heating period
- **In automatic mode, one temperature setpoint can be adjusted for each heating period**

Use

In combination with Boiler Management Units (BMU) or heating controllers with OpenTherm Plus interface. For the control of the room temperature in:

- Apartments, single-family or 2-family houses
- Smaller multifamily houses
- Holiday houses and villas

Application

For use in all standard heating systems, such as radiator or convector heating systems. Especially suited for heating plants with pump heating circuits. If the boiler control systems feature integrated mixing valve control, it is also possible to control mixing heating circuits.

Functions

- Delivery of the flow temperature setpoint
- Pure room temperature control
- Permanent self-learning PID control for normal and fast control loops
- 2-position control for difficult controlled systems
- Automatic mode with 7-day switching program for 24-hour, working day, weekend or 7-day operation with up to 3 heating periods per day (4th priority for actual valid temperature setpoint)
- Integrated 7-day time switch
- One temperature setpoint for each heating period
- One 24-hour operating mode with one heating period
- Remote operation (1st priority for actual valid temperature setpoint)
- Override button (3rd priority for actual valid temperature setpoint)
- Sensor calibration and reset function
- Frost protection function
- Limitation of the minimum setpoint
- Holiday mode (2nd priority for actual valid temperature setpoint)
- Optimum start control for the first heating period
- If provided by the boiler, alternating display of: relative modulation level, flow temperature, outside temperature and DHW setpoint
- If provided by the boiler, display of error code in case of error
- Transmitting of actual operating mode to a Siemens boiler management unit (refer to user guide of boiler management unit)

Ordering

Room temperature controller with 7-day time switch

REA23M

When ordering, please give the type reference.
The controller is supplied complete with batteries.

Technical design

Communication

The OpenTherm bus is used for communication between room temperature controller and boiler control. The REA23M can only be used in combination with an OpenTherm Plus boiler.

OpenTherm Plus affords reading and writing of several compatible standard objects between room temperature controller and boiler control via the bus.

Immediately after installation, the room temperature controller examines if the connected BMU supports the OpenTherm Plus protocol. If OpenTherm Plus is not supported, error message  will be displayed.

Display and operating elements

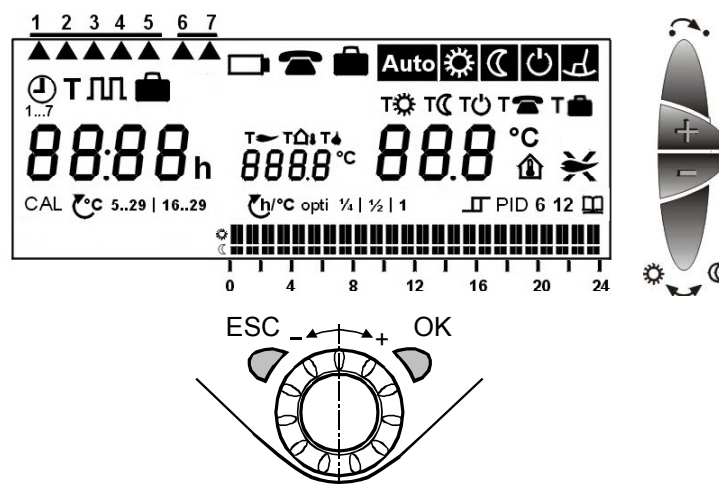

Operating elements

		<p>Selection of operating mode (4th priority for actual valid temperature setpoint)</p> <p>Warmer button</p> <p>Colder button</p> <p>Override button (3rd priority for actual valid temperature setpoint)</p> <p>Leaving the current menu level and returning to the previously active menu level (the settings currently displayed will be accepted)</p> <p>The rotary knob is only operable within the menus. Move from menu to menu, modify adjustable variables (temperature in increments of 0.2°C and time in hours and minutes) and select functions.</p> <p>Access the menus, enable a menu, save inputs, switch to the next menu option and acknowledge with the OK button.</p>
--	---	--

Normal display

	<p>Time of day</p> <p>Room temperature</p> <p>Relative modulation level in %</p> <p>Flow temperature</p> <p>Outside temperature</p> <p>DHW temperature setpoint</p> <p>Change batteries (display appears about 3 months before batteries are exhausted)</p> <p>Remote control active (1st priority for actual valid temperature setpoint)</p> <p>Holiday mode active (2nd priority for actual valid temperature setpoint)</p>	<p>Alternating display / alternates each few seconds</p> <p>(If provided by the boiler, automatic display of these data. Display can not be suppressed manually.)</p>
--	--	--

Error display

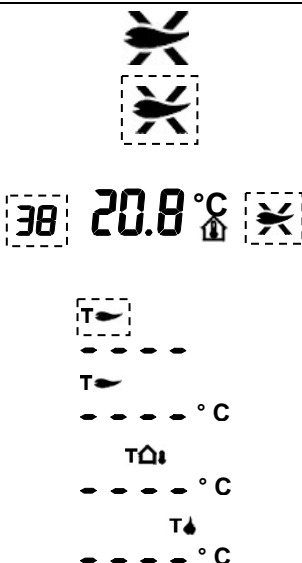
		<p>Permanent display: Communication with BMU incorrect or REA23M is not placed on its base.</p> <p>Flashing display: BMU reports an error</p> <p>Flashing display: BMU reports an error and writes its error code on display. (automatic display, can not be suppressed manually)</p> <p>Error in transmission of relative modulation level</p> <p>Error in transmission of flow temperature or sensing element for flow temperature defect</p> <p>Error in transmission of outside temperature or sensing element for flow temperature defect</p> <p>Error in transmission of D.H.W. setpoint</p>
--	---	---

Error is being displayed latest 2 minutes after error occurs.

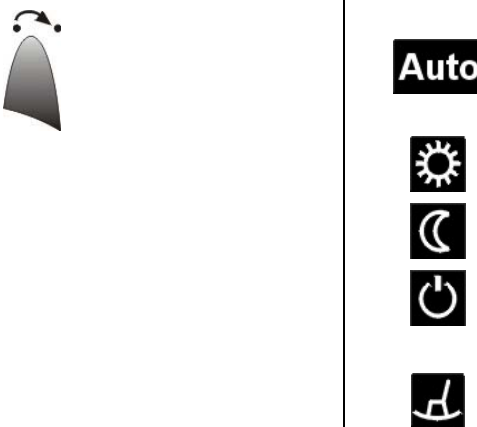

Selection of operating mode (only one operating mode is active)

(4th priority for actual valid temperature setpoint)



	<p>Auto</p> <p>Comfort mode</p> <p>Economy mode</p> <p>Frost protection</p> <p>24-hour mode with one heating period</p>	<p>Automatic mode</p> <p>Comfort mode</p> <p>Economy mode</p> <p>Frost protection</p> <p>24-hour mode with one heating period (heating period is automatically generated from the current 24-hour program)</p>
---	--	---

Temporary change of the current setpoint temperature







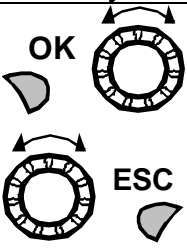

(change only active until the next switching point is reached)

		<p>When pressing the + or – button once, the adjusted setpoint temperature will be displayed. It can be readjusted in increments of 0.2 °C (max. +/- 4 °C).</p>
---	---	---

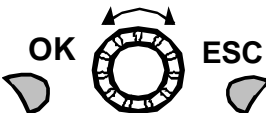
Override button

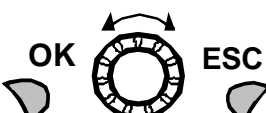
	<p>In operating modes Auto and , this button can be used to switch from comfort to economy temperature, or vice versa. The selection is maintained until the next switching point is reached or until the operating mode is changed. (3rd priority for actual valid temperature setpoint)</p>
---	--

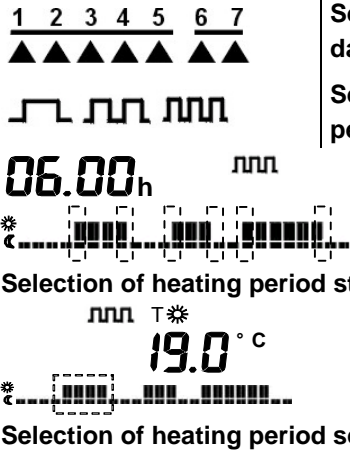
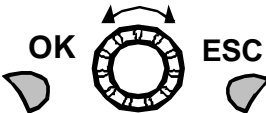
Menu-driven user settings: 4 main menus available

Time of day and day	Main menu	Submenu	Settings
			<p>Current time of day</p> <p>Current day of week</p>
			<p>Factory settings</p> <p>Setpoint comfort mode 19 °C</p> <p>Setpoint economy mode 16 °C</p> <p>Setpoint frost protection 5 °C</p> <p>Setpoint economy mode remote operation 10 °C</p>
		 <p>Selection of day of week, working day, weekend or week</p> <p>Selection of the number of heating periods, max. 3</p> <p>Selection of heating period start and end time</p> <p>Selection of heating period setpoint temperature</p>	
			<p>Entry of holidays or periods of absence. (Number of days with economy mode setting / max. 99 days)</p> <p>Temperature setpoint during absence</p> <p>Factory setting 12 °C</p>

Menu-driven heating engineer settings

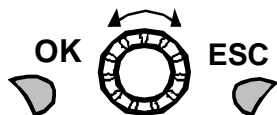

Main menu

CAL

°C 5..29 | 16..29

h/°C opti ¼ | ½ | 1



PID

PID 6 | 12

Settings

Sensor calibration

Setpoint limitation

Optimum start control for the first heating period (in unit of time per 1 °C)

2-position control

PID mode, permanent-self-learning

PID6 mode for fast and PID12 mode for normal controlled systems

Temperature setpoints

In automatic operating modes, temperature setpoints can be individually adjusted for every comfort period and for the continuous operating modes. The temperature setpoint of economy mode is the same in automatic and continuous operation.

Protective function



In the frost protection mode, the room temperature is constantly monitored. If it falls below the adjusted setpoint, heating is switched on to maintain the adjusted frost protection setpoint temperature .

24-hour operating mode



The controller generates the 24-hour operating mode from the current 24-hour program. It automatically selects the switch-on time of the first heating period and the switch-off time of the last heating period to generate and display a complete heating period. The comfort temperature used by the controller is the currently stored standard setpoint of the continuous operating mode . The self-generated 24-hour operating mode is maintained until another operating mode is selected.

Example

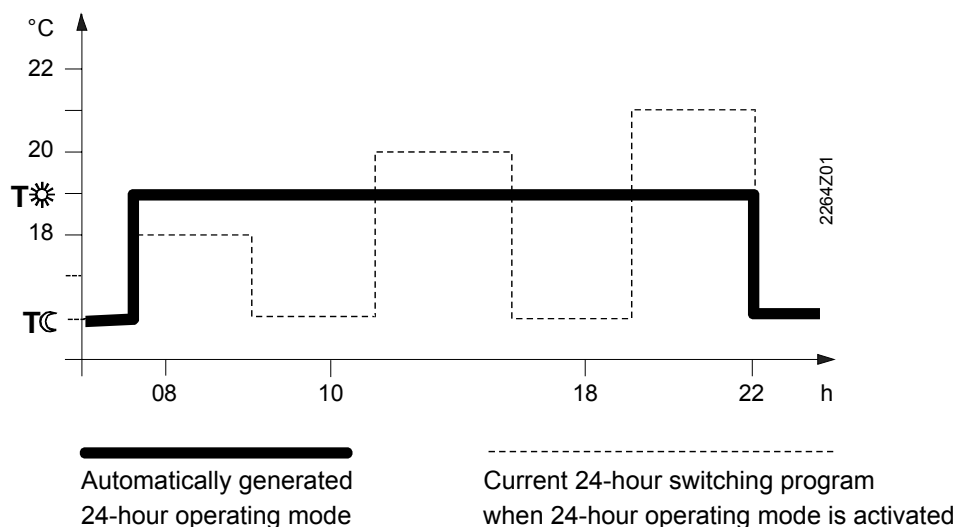

Switching program



The switching program can be used as a 7-day or 24-hour switching program, depending on programming. It is also possible to select one of the continuous operating modes with which the switching program is not used.

With the 7-day switching program, it is possible to program all days individually, the working days (1-5), the weekend (6-7), or the entire week (1-7).

When a heating period is programmed, 3 different switching patterns are available. It is possible to select 1, 2 or 3 heating periods. For each heating period, the start time, end time and comfort setpoint are to be entered. In between heating periods, it is always the same economy temperature setpoint that is used. This economy temperature setpoint can be adjusted on the temperature menu.

Example with 2 heating periods per day

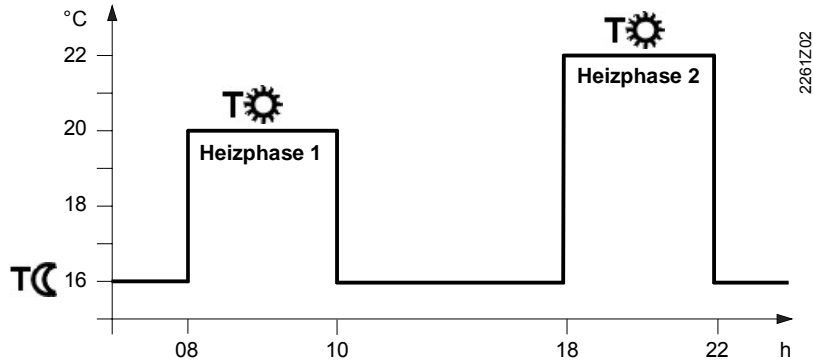

Holiday function



The holiday function is to be selected on the user menu. Set the start of the holiday period (day of departure/ $\frac{1}{2} \frac{2}{3} \frac{3}{4} \frac{4}{5} \frac{5}{6} \frac{6}{7}$ / day of week), the duration and the temperature setpoint (**T**) during your absence. This will enable the controller to maintain the required temperature for a period of up to 99 days. Every midnight, the counter subtracts one day.

When the holiday period is over and the counter reads 00, the controller will resume the operating mode selected last.

(2nd priority for actual valid temperature setpoint)

Remote operation



Using a suitable remote operator unit, the controller can be switched to an independently adjustable economy temperature **T** . Changeover is accomplished by the making of a potential free contact connected to terminals T1 and T2. In that case, symbol will appear on the display. When the contact opens, the operating mode selected last will be resumed.

(1st priority for actual valid temperature setpoint)

Operation according to the setting made on the controller	Continuous remote operation economy temperature

Remote operating devices

Suitable remote operator units:

Telephone modem, manual switch, window switch, occupancy detector, central unit, etc.





Transmission of actual operating mode to Siemens boiler management unit

When REA23M recognizes a connected boiler management unit **LMU33, LMU36, LMU54, LMU55, LMU64, LMU65** from Siemens (refer to user guide), the actual operating mode of the REA23M is being transmitted to the boiler management unit. Connecting other Siemens boiler management units or boiler management units from other manufacturers, the actual operating mode of the REA23M is not being transmitted. This procedure runs automatically. It can neither being influenced manually nor being switched off.

Following data of actual operating mode is being transmitted to the boiler management unit by ID129:

REA23M	Frost protection	(active in operating mode „Frost protection“)
	Reduced	(active in operating modes "continuous economy mode“, "holiday mode“, with active remote control and during economy periods in operating modes "Auto" and "24-hour operating mode with one heating period“)
	Nominal	(active in operating mode "continuous comfort mode“ and during comfort phases in operating modes "Auto" and „24-hour operating mode with one heating period“)
	Quick setback	(active when adjusting a lower temperature setpoint, e.g. changing operating mode from "continuous comfort mode“ to "continuous economy mode“)

Factory settings

Operating mode	Block / week-days	Switching times						Temperatures in °C						
		1 st period		2 nd period		3 rd period		T ₁ [☀] 1 st period	T ₂ [☀] 2 nd period	T ₃ [☀] 3 rd period	T _☾	T _☺	T _☎	T _☑
Auto	1-5 Mo-Fr 6-7 Sa-Su	06.00	08.00	11.00	13.00	17.00	22.00	19	20	21	16			
	1-7 Mo-Su	00.00	24.00					19						
	1-7 Mo-Su	00.00	24.00								16			
	1-7 Mo-Su	00.00	24.00									5		
													10	
	Absence													12

Factory settings
heating engineer level

Setpoint limitation

 5..29

Optimum start control

 h/°C opti (OFF)

Temperature control:

PID  (permanent self-learning)

Heating engineer level

Access

The heating engineer level will be enabled by pressing simultaneously the warmer and colder buttons and by turning the setting knob counter-clockwise and then clockwise.

Sensor calibration

CAL

If the displayed temperature does not agree with the effective room temperature, the temperature sensor can be recalibrated (recalibration to be made on the heating engineer menu).

The displayed temperature can be matched to the effective room temperature in increments of 0.2 °C (max. ±2 °C).

Limitation of setpoint

°C 5..29 | 16..29

Minimum setpoint limitation of 16 °C prevents undesired heat transfer to neighboring apartments in buildings with several heating zones. The setting is to be made on the heating engineer menu.

Optimum start control

h/°C opti ¼....

Optimization brings forward the switch-on point of the first heating period such that the adjusted setpoint will be reached at the desired time.

The setting depends on the type of controlled system, that is, on heat transmission (type of piping system, radiators), building dynamics (building mass, insulation), and heat output (boiler capacity, flow temperature).

Example with an actual room temperature of 18 °C and a setpoint of 20 °C:

Optimum start control is switched off at **h/°C opti**

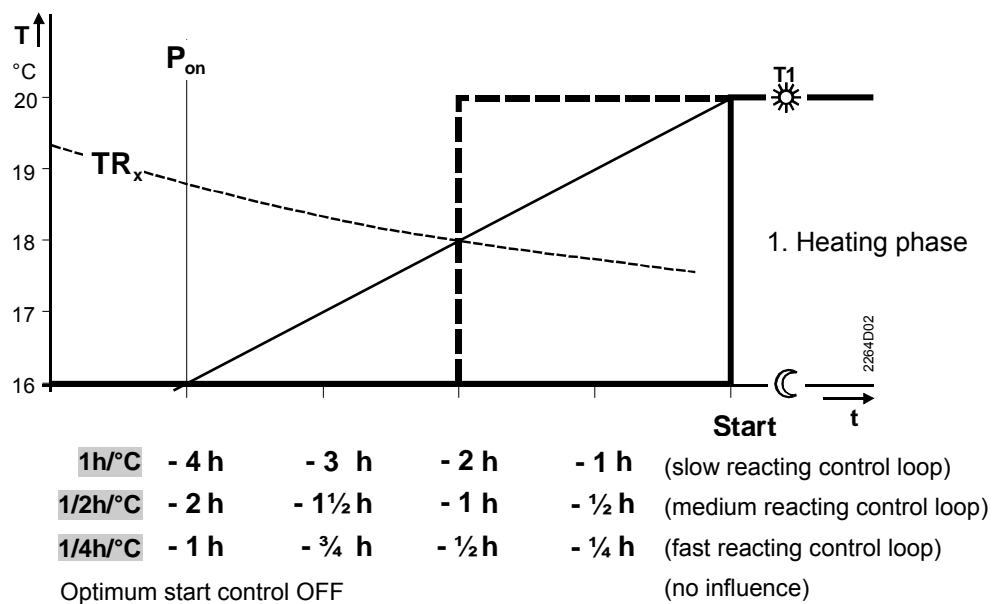

T Temperature (°C)

t Forward shift of switch-on point (h)

TR_x Actual value of room temperature

P_{on} Starting point of optimum start control

Control

The REA23M is a communicating controller providing PID mode.

The control (boiler and REA23M) delivers the necessary flow temperature depending on the deviation of the adjustable setpoint from the actual value acquired by the built-in temperature sensor.

The rate of response to the deviation depends on the selected control algorithm:

Permanent-self-learning operating mode

PID

By default (factory setting) the controller operates in self-learning operating mode, whereby it automatically adapts to the controlled system (type of building construction, heating capacity, type of heaters, room size etc.). After a learning period, the controller self-optimizes the parameters and then operates in accordance with the newly learned parameters.

Exceptions	In exceptional cases, in which the permanent-self-learning mode may not be ideal, PID 12, PID 6 or 2-Pt mode can be selected:
PID 12	PID 12 mode For normal or slow controlled systems (massive building structures, large spaces, cast-iron radiators, oil burners).
PID 6	PID 6 mode For fast controlled systems (light building structures, small spaces, plate radiators or convectors, gas burners).
	2-Pt mode Simple 2-position control with a switching differential of 0.5 °C (±0.25 °C) for very difficult controlled systems with considerable outside temperature variations.
Reset functions	<p>User-defined data: Press the button behind the pin opening for at least 1 second: This resets the user specific settings and the “Permanent-self-learning operating mode” as well as display of flow temperature, outside temperature and DHW setpoint to their default values (the heating engineer settings will not be changed). The clock starts at 12:00. During the reset time, all sections of the display light up, enabling them to be checked.</p> <p>All user-defined data plus heating engineer settings: Press the button behind the pin opening together with the warmer and colder buttons for at least 1 second. After this reset, all factory settings will be reloaded (also refer to section “Factory settings”).</p>
Caution	Without inserted batteries, reset functions correctly for a maximum of 15 seconds only after removing REA23M from its base.

Mechanical design

Controller	The REA23M has a plastic housing with a large display and easily accessible operating elements. The controller is removed from its base by sliding it upward. It is thus possible to replace the two 1.5 V alkaline batteries type AA in the compartment at the rear of the unit.
Battery change	About 3 months before the batteries are exhausted, battery symbol  appears on the display, but all functions will be fully maintained. When changing the batteries, the current data will be retained for a maximum of 1 minute.
Base	The base can be fitted to most types of commercially available recessed conduit boxes or directly on the wall for wiring. The base only houses the terminals for the electrical connection between the controller and the connected devices. The entire electronics (including the relay with a potential free changeover contact) are accommodated in the controller.

Notes

Engineering	<ul style="list-style-type: none"> • The room temperature controller should be located in the main living room • The place of installation should be chosen such that the sensor can capture the room temperature as accurately as possible, without being affected by direct solar radiation or other heating or cooling sources • Mounting height is approximately 1.5 m above the floor • The controller can be fitted to most commercially available recessed conduit boxes or directly on the wall • Above the unit, there must be sufficient clearance for removing the controller from its base and for replacing it
--------------------	--

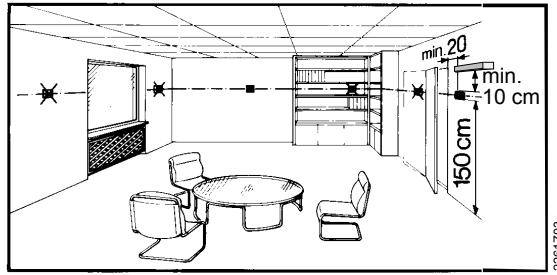

Mounting and installation

- When installing the controller, the base must first be fitted and wired. Then, the unit can be slid onto the base from above
- For more detailed information, please refer to the Installation Instructions supplied with the controller
- For the electrical installation, the local safety regulations must be complied with
- The remote operation contact T1 / T2 must be wired separately using a separate shielded cable

Commissioning

- The battery transit tab, which prevents inadvertent operation of the controller during transport and storage, must be removed
- The control mode can be changed on the heating engineer level
- If the reference room is equipped with thermostatic radiator valves, they must be set to their fully open position
- If the displayed room temperature does not agree with the effective room temperature, the temperature sensor should be recalibrated (refer to “Sensor calibration”)

Technical data

Power supply	OpenTherm bus	
	Connection	2 wires, interchangeable
	Length of cable	Max. 50 m
	Resistance of cable	Max. 2 x 5 Ω
Battery data	Power consumption	35 mW (typical)
	Batteries (Alkaline AA)	2 x 1.5 V
	Battery life	Approx. 2 years
	Backup for battery change	Max. 1 minute
Data backup (unit removed from base / no batteries inserted)	Data backup (unit removed from base / no batteries inserted)	
	User settings	Approx. 10 years
	Actual time (without batteries)	Max. 1 minute
Safety data	Safety class	III to EN 60730 when installed according to regulations
	Degree of protection of housing	IP 20 to EN 60529
	Pollution	Environment to EN 60730
Sensing element various features	Sensing element	NTC 10 k Ω \pm 1 % at 25 °C
	Measuring range	0...50 °C
	Time constant	Max. 10 min
	Setpoint setting ranges	
	Normal temperature	5...29 °C
	Economy temperature	5...29 °C
	Frost protection temperature	5...29 °C (factory setting 5 °C)
	Resolution of settings and display	
	Setpoints	0.2 °C
	Switching times	10 min
Measurement of actual value	0.1 °C	
Display of actual value	0.2 °C	
Display of time	1 min	
Norms and standards	CE conformity	
	Electromagnetic compatibility	89/336/EWG
	Low voltage directive	2006/95/EWG
	Product safety	
	Automatic electrical controls for household and similar use	EN 60730-1, EN 60730-2-9
		
	OpenTherm Plus (OT/+)	OpenTherm Product Specification 2.2a OpenTherm Test Specification 1.2
	Electromagnetic compatibility	
	Immunity	EN 61000-6-1, EN 61000-6-2, EN50 090-2
	Emissions	EN 61000-6-3, EN 61000-6-4, EN50 090-2-2

Environmental conditions

Operation	
Climatic conditions	3K3 to IEC 60 721-3
Perm. Ambient temperature	5...40 °C
Humidity	< 85 % r.h.
Storage and transport	
Climatic conditions	2K3 to IEC 60 721-3
Temperature	-25...70 °C
Humidity	< 93 % r.h.
Mechanism	
	2M2 to IEC 60 721-3
Weight	Incl. package 0.31 kg
Color	Housing Signal white RAL9003
	Base Gray RAL7038
Size	Housing 140 x 104.5 x 30 mm

Connection diagram

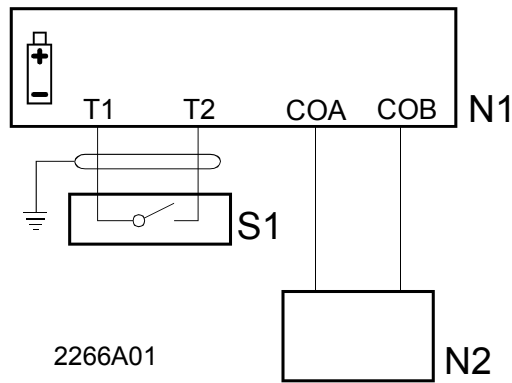

- N1 Room temperature controller REA23M
- S1 Remote operator unit (potential free)
- T1 Signal „Remote operation“
- T2 Signal „Remote operation“
- COA OpenTherm contact A (interchangeable)
- COB OpenTherm contact B (interchangeable)
- N2 BMU OpenTherm Plus

Application example

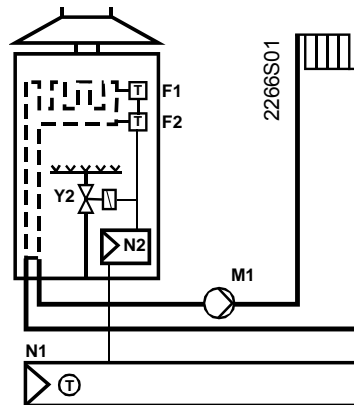

Instantaneous water heater

- F1 Thermal reset limit thermostat
- F2 Safety limit thermostat
- M1 Circulating pump
- N1 Room temperature controller REA23M
- N2 BMU
- Y2 Motorized 2-port valve

Dimensions

