

	FDMH292-R
en	Housing for manual call point 'Heavy Duty'
de	Gehäuse für Handfeuermelder 'Heavy Duty'
fr	Boîtier pour déclencheur manuel 'Heavy Duty'
es	Carcasa para pulsador manual 'Heavy Duty'
it	Contenitore per pulsanti manuali 'Heavy Duty'

en	Installation
de	Montage
fr	Montage
es	Montaje
it	Montaggio

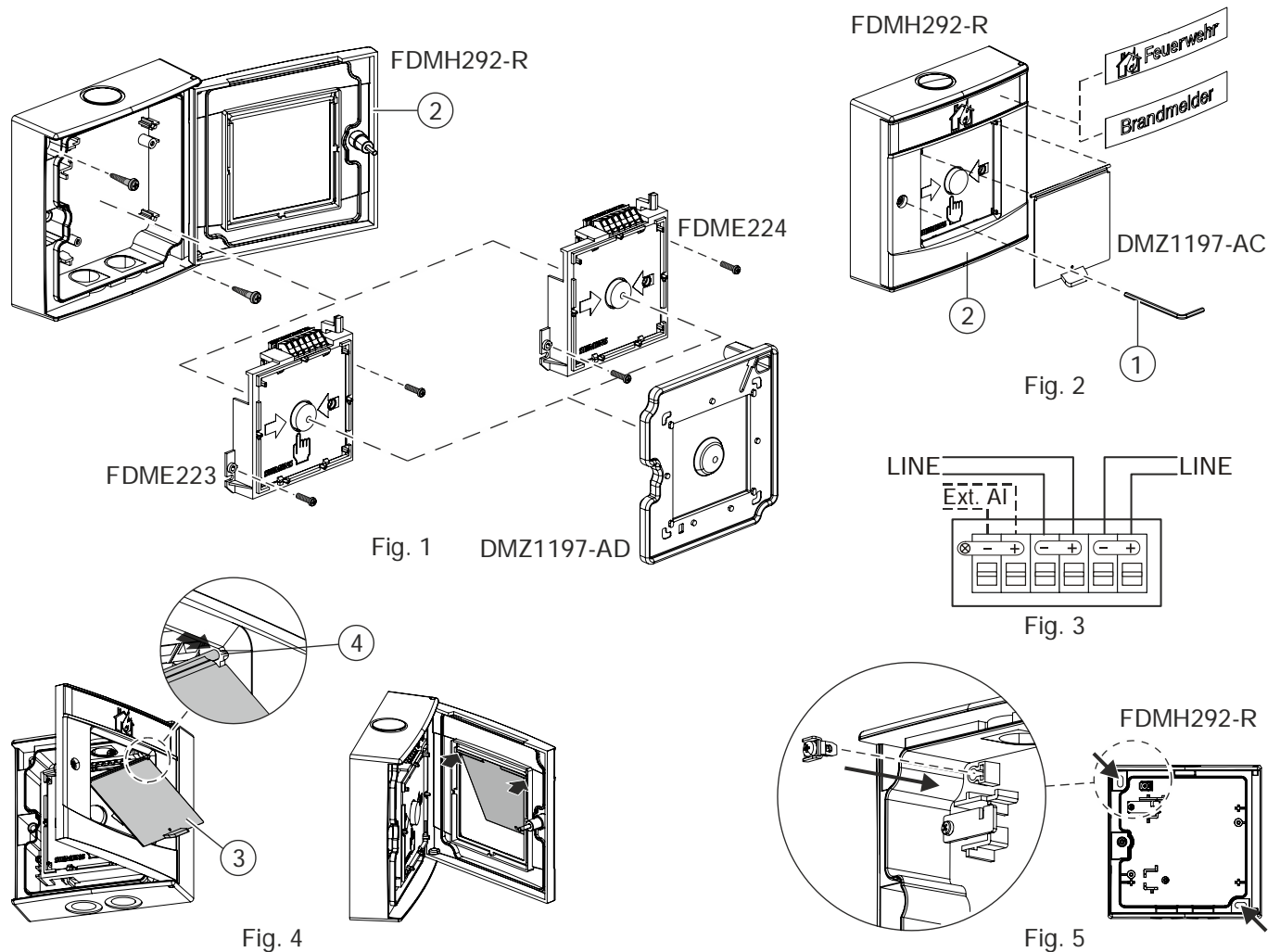

	en	de	fr	es	it
1	Socket head wrench	Innensechskant-Schlüssel	Clé à six pans creux	Llave Allen	Brugola
2	Door	Tür	Porte	Puerta	Sportello
3	Protective cover	Schutzdeckel	Couvercle	Cubierta protectora	Coperchio protettivo
4	Pivot pin	Drehzapfen	Tourillon	Pivote	Perno

Intended use

The manual call points FDM223H/FDM224H and DM1103/04H activate alarms manually in the event of a fire. They consist of a 'Heavy Duty' housing FDMH292-R and a switching unit.

A protective cover, a seal for protection category IP64, and a metal cable gland can be supplied as accessories (see Fig. 1 and Fig. 2).

Preparation

1. Use the Allen key (1) supplied to open the door (2) of the housing (see Fig. 2). Keep the Allen key (1) in a safe place.
2. Determine the feed opening in the housing and break it out from above or below.

Installation

1. Secure the housing at a height of 0.9...1.6 m on an even surface.



Observe the country-specific regulations for the exact installation height!

- Only use the screw holes marked by arrows (see Fig. 5).
2. Pull the cable through the supplied cable grippers.
 3. Pull the cable into the housing through the feed opening.
 4. Use the Allen key (1) to close the door (2).
 5. If necessary: Stick a self-adhesive 'Fire detector' or 'Fire brigade' sticker on the door (2) (see Fig. 2).

Use in wet areas (protection category IP64)

- Use the metal cable gland (accessories).
- Use a seal DMZ1197-AD (accessories).
- Close unused housing openings.

Installing the protective cover DMZ1197-AC

1. Use the Allen key (1) supplied to open the door (2) of the housing (see Fig. 2). Keep the Allen key (1) in a safe place.
2. Remove the glass insert.
3. Guide the protective cover (3) through the opening in the door (2) from the front (Fig. 4).
4. Insert the pivot pins (4) for the protective cover (3) in the two recesses on the rear side of the door (2).
5. Install the glass insert.
6. Close the door.

Installing the seal DMZ1197-AD

1. With the door (2) open, lay the seal on the installed switching unit.
2. Use the Allen key (1) to close the door (2).

Connecting the switching unit to the electricity

1. Use the Allen key (1) to open the door (1).
2. If the detector line cables (LINE) are shielded, connect the shieldings to an auxiliary terminal in the back box (see Fig. 5). When the external alarm indicator (Ext. AI) is connected via a shielded cable, the shielding must be connected to the positive pole of the alarm indicator by means of an auxiliary terminal.

The shielding must not touch any other potentials or metal parts in the manual call point.

3. Connect the feed line to the terminals in the switching unit (see Fig. 3) in accordance with the connection diagram.

Note the positive and negative poles.



Only connect one wire per terminal. This is the only way to ensure the connection is failure-free for the entire service life of the device.

4. When inserting the switching unit into the housing, note the feed line. Avoid crushing the feed line.
5. Insert the switching unit in the housing with the terminals facing upwards and secure it using two screws.

**WARNING!****Deactivating the manual call points prevents alarms from being forwarded**

Alarming does not take place
Mark deactivated or non-functional manual call points with "NOT IN USE"!

6. Use the Allen key (1) to close the door (2).

Connect the other switching units correspondingly.



You will find more information in document 007002.

Verwendungszweck

Die Handfeuermelder FDM223H/FDM224H und DM1103/04H dienen der manuellen Auslösung von Alarmen in Brandfällen. Sie bestehen aus einem Gehäuse FDMH292-R 'Heavy Duty' und einem Schaltungseinsatz.

Als Zubehör sind ein Schutzdeckel und für Schutzart IP64 eine Dichtung sowie eine Metall-Kabelverschraubung lieferbar (siehe Fig. 1 und Fig. 2).

Vorbereitung

1. Öffnen Sie mit dem mitgelieferten Innensechskant-Schlüssel (1) die Tür (2) des Gehäuses (siehe Fig. 2). Bewahren Sie den Innensechskant-Schlüssel (1) sicher auf.
2. Bestimmen Sie die Zuleitungsöffnung im Gehäuse und brechen Sie diese von oben oder unten aus.

Montage

1. Befestigen Sie das Gehäuse in einer Höhe von 0,9...1,6 m auf einer planen Oberfläche.



Beachten Sie landesspezifische Vorschriften für die exakte Montagehöhe!

- Verwenden Sie nur die mit Pfeil markierten Schraubenlöcher (siehe Fig. 5).
2. Ziehen Sie das Kabel durch die mitgelieferten Würgenippel.
 3. Ziehen Sie das Kabel durch die Zuleitungsöffnung ins Gehäuse ein.
 4. Schließen Sie die Tür (2) mit dem Innensechskant-Schlüssel (1).
 5. Falls erforderlich: Kleben Sie ein Selbstklebeetikett 'Brandmelder' oder 'Feuerwehr' auf die Tür (2) (siehe Fig. 2).

Einsatz in Nassbereichen (Schutzart IP64)

- Verwenden Sie die Metall-Kabelverschraubung (Zubehör).
- Verwenden Sie eine Dichtung DMZ1197-AD (Zubehör).
- Verschließen Sie ungenutzte Gehäuseöffnungen.

Montage Schutzdeckel DMZ1197-AC

1. Öffnen Sie mit dem mitgelieferten Innensechskant-Schlüssel (1) die Tür (2) des Gehäuses (siehe Fig. 2). Bewahren Sie den Innensechskant-Schlüssel (1) sicher auf.
2. Entfernen Sie den Glaseinsatz.
3. Fädeln Sie den Schutzdeckel (3) von der Vorderseite durch die Öffnung in der Tür (2) (Fig. 4).
4. Legen Sie die Drehzapfen (4) des Schutzdeckels (3) in die beiden Vertiefungen auf der Rückseite der Tür (2) ein.
5. Montieren Sie den Glaseinsatz.
6. Schließen Sie die Tür.

Montage Dichtung DMZ1197-AD

1. Legen Sie bei geöffneter Tür (2) die Dichtung auf den montierten Schaltungseinsatz.
2. Schließen Sie die Tür (2) mit dem Innensechskant-Schlüssel (1).

Elektrischer Anschluss des Schaltungseinsatzes

1. Öffnen Sie die Tür (2) des Gehäuses mit dem Innensechskant-Schlüssel (1).
2. Falls die Melderlinienkabel (LINE) abgeschirmt sind, verbinden Sie die Abschirmungen mit einer Zusatzklemme im Gehäuseboden (siehe Fig. 5). Wird der externe Alarmindikator (Ext. Al) über ein abgeschirmtes Kabel angeschlossen, muss die Abschirmung mit einer Zusatzklemme mit dem Plus-Anschluss des Alarmindikators verbunden werden. Die Abschirmungen dürfen keine anderen Potenziale oder Metallteile im Handfeuermelder berühren.
3. Schließen Sie die Zuleitung gemäß Anschlusschema an die Klemmen im Schaltungseinsatz an (siehe Fig. 3).



Beachten Sie die Plus- und Minus-Anschlüsse. Schließen Sie pro Klemme nur einen Draht an. Nur so kann ein störungsfreier Anschluss über die gesamte Lebensdauer des Gerätes gewährleistet werden.

4. Achten Sie beim Einführen des Schaltungseinsatzes ins Gehäuse auf die Zuleitung. Vermeiden Sie Quetschungen der Zuleitung.
5. Setzen Sie den Schaltungseinsatz mit den Klemmen nach oben gerichtet ins Gehäuse ein und befestigen Sie ihn mit zwei Schrauben.



WARNING!

Deaktivierte Handfeuermelder verhindern die Weiterleitung von Alarmen

Die Alarmierung findet nicht statt
Kennzeichnen Sie deaktivierte oder nicht funktionsfähige Handfeuermelder mit dem Hinweis „AUSSER BETRIEB“!

6. Schließen Sie die Tür (2) mit dem Innensechskant-Schlüssel (1).

Schließen Sie andere Schaltungseinsätze sinngemäß an.



Weitere Informationen finden Sie im Dokument 007002.

Domaine d'utilisation

Les déclencheurs manuels FDM223H/FDM224H et DM1103/04H servent à l'activation manuelle d'alarmes en cas d'incendie. Ils se composent d'un boîtier FDMH292-R 'Heavy Duty' et d'une unité de commutation.

Un couvercle de protection et un joint pour la catégorie de protection IP64 ainsi qu'un presse-étoupe métallique sont disponibles en accessoires (voir fig. 1 et fig. 2).

Préparation

1. Ouvrez la porte (2) du boîtier avec la clé à six pans creux (1) fournie (voir fig. 2). Rangez soigneusement la clé à six pans creux (1).
2. Déterminez l'ouverture de câble d'alimentation dans le boîtier et pratiquez-la dans le haut ou dans le bas.

Montage

1. Fixez le boîtier à une hauteur de 0,9...1,6 m sur une surface plane.



Respectez les prescriptions spécifiques aux pays pour la hauteur exacte de montage !

- Utilisez uniquement les trous de vis marqués par une flèche (voir fig. 5).
2. Tirez le câble par le manchon à bordure rainurée fourni.
 3. Tirez le câble par l'ouverture de câble d'alimentation dans le boîtier.
 4. Fermez la porte (2) avec la clé à six pans creux (1).
 5. Si nécessaire : Apposez un panneau de fenêtre 'Détecteur d'incendie' ou 'Sapeurs-pompiers' sur la porte (2) (voir fig. 2).

Utilisation dans des zones humides (catégorie de protection IP64)

- Utilisez le presse-étoupe métallique (accessoire).
- Utilisez un joint DMZ1197-AD (accessoire).
- Fermez les orifices du boîtier non utilisés.

Montage du couvercle de protection DMZ1197-AC

1. Ouvrez la porte (2) du boîtier avec la clé à six pans creux (1) fournie (voir fig. 2). Rangez soigneusement la clé à six pans creux (1).
2. Retirez l'insert en verre.
3. Placez le couvercle de protection (3) par l'avant dans l'ouverture de la porte (2) (fig. 4).
4. Insérez les tourillons (4) du couvercle de protection (3) dans les deux cavités sur la partie arrière de la porte (2).
5. Remontez l'insert en verre.
6. Fermez la porte.

Montage joint DMZ1197-AD

1. Posez le joint sur l'unité de commutation montée alors que la porte est ouverte (2).
2. Fermez la porte (2) avec la clé à six pans creux (1).

Raccordement électrique de l'unité de commutation

1. Ouvrez la porte (2) du boîtier avec la clé à six pans creux (1).
2. Si les câbles de ligne de détection (LINE) sont blindés, raccordez les blindages à un terminal auxiliaire dans le boîtier arrière (voir fig. 5). Si l'indicateur d'action externe (IA ext.) est raccordé via un câble blindé, le blindage doit être relié via un terminal auxiliaire au pôle positif de l'indicateur d'action.
Les blindages ne doivent être en contact avec aucun autre potentiel ni aucune pièce métallique dans le déclencheur manuel.
3. Raccordez le câble d'alimentation aux bornes dans l'unité de commutation conformément au schéma de raccordement (voir fig. 3).

Veillez à porter attention aux pôles positifs et négatifs.



Ne raccordez qu'un fil par borne. C'est la seule manière de garantir un raccordement sans perturbation pendant toute la durée de vie de l'appareil.

4. Faites attention au câble d'alimentation lors de l'introduction de l'unité de commutation dans le boîtier. Evitez d'écraser le câble d'alimentation.
5. Placez l'unité de commutation avec les bornes vers le haut dans le boîtier et fixez-la avec deux vis.

**AVERTISSEMENT !**

Les déclencheurs manuels désactivés empêchent la transmission d'alarmes.

La mise en alarme n'a pas lieu
Identifiez les déclencheurs manuels désactivés ou non opérationnels, ils doivent être pourvus de l'indication "HORS SERVICE" !

6. Fermez la porte (2) avec la clé à six pans creux (1).

Raccordez les autres unités de commutation de façon analogue.



Pour de plus amples informations, se référer au document 007002.

Uso previsto

Los pulsadores manuales FDM223H/FDM224H y DM1103/04H se utilizan para la activación manual de alarmas en casos de incendio. Constan de una carcasa FDMH292-R 'Heavy Duty' y de una electrónica de pulsador. Como accesorios pueden suministrarse una cubierta protectora y, para la categoría de protección IP64, una junta, así como un prensaestopas metálico para cable (véase Fig. 1 y Fig. 2).

Preparativos

1. Abra la puerta (2) de la carcasa con la llave Allen (1) suministrada (véase fig. 2). Guarde la llave Allen (1) en un lugar seguro.
2. Determine el orificio de entrada de cables en la carcasa y rómpalo por arriba o por abajo.

Montaje

1. Fije la carcasa a una altura de 0,9...1,6 m sobre una superficie plana.



¡Cumpla las normas nacionales para la altura de montaje exacta!

- Utilice solamente los agujeros roscados marcados con la flecha (véase Fig. 5).
2. Introduzca el cable en el racor suministrado.
 3. Introduzca el cable en la carcasa a través del orificio de entrada de cables.
 4. Cierre la puerta (2) con la llave Allen (1).
 5. Si es necesario: Pegue la etiqueta autoadhesiva 'Detector de incendios' o 'Fuerza de Bomberos' en la puerta (2) (véase Fig. 2).

Empleo en entornos húmedos (categoría de protección IP64)

- Utilice el prensaestopas metálico para cable (accesorios).
- Utilice una junta DMZ1197-AD (accesorios).
- Cierre los orificios no utilizados de la carcasa.

Montaje de la cubierta protectora DMZ1197-AC

1. Abra la puerta (2) de la carcasa con la llave Allen (1) suministrada (véase fig. 2). Guarde la llave Allen (1) en un lugar seguro.
2. Retire la pieza de cristal.
3. Enganche la cubierta protectora (3) en la puerta (2) desde la parte delantera a través del orificio (fig. 4).
4. Inserte los pivotes (4) de la cubierta protectora (3) en las dos cavidades del lado posterior de la puerta (2).
5. Monte la pieza de cristal.
6. Cierre la puerta.

Montaje de la junta DMZ1197-AD

1. Estando abierta la puerta (2), coloque la junta sobre la electrónica de pulsador montada.
2. Cierre la puerta (2) con la llave Allen (1).

Conexión eléctrica de la electrónica de pulsador

1. Abra la puerta (2) de la carcasa con la llave Allen (1).
2. Si los cables de la línea de detectores (LINE) están apantallados, conecte los apantallamientos por medio de un terminal auxiliar en el fondo de la carcasa (véase Fig. 5). Si el indicador de alarma externo (IA ext.) se conecta a través de un cable apantallado, el apantallamiento debe conectarse con un terminal auxiliar a el polo positivo del indicador de alarma. Los apantallamientos no deben tocar ningún otro potencial ni piezas de metal en el pulsador manual.
3. Conecte el cable de alimentación de acuerdo con el diagrama de conexión en los terminales de la electrónica de pulsador (véase Fig. 3).

Observe los polos positivos y negativos.



Conecte únicamente un hilo por terminal. Solo así se puede garantizar una conexión libre de problemas durante toda la vida útil del dispositivo.

4. Preste atención al cable de alimentación al introducir la electrónica de pulsador en la carcasa. Evite que se aplaste el cable de alimentación.
5. Introduzca la electrónica de pulsador con los terminales hacia arriba en la carcasa, y fíjela con dos tornillos.

**¡ADVERTENCIA!****Los pulsadores manuales desactivados impiden la transferencia de alarmas**

La notificación de la alarma no tiene lugar
¡Señalice los pulsadores manuales que estén desactivados o no funcionen correctamente con el aviso "FUERA DE SERVICIO"!

6. Cierre la puerta (2) con la llave Allen (1).

Conecte otras electrónicas de pulsador de forma análoga.



Para más información, consulte el documento 007002.

Destinazione d'uso

I pulsanti manuali FDM223H/FDM224H e DM1103/04H servono per l'attivazione manuale di allarmi in caso di incendio. Consistono di un contenitore FDMH292-R 'Heavy Duty' e di un'unità interna pulsante.

Come accessori opzionali sono disponibili un coperchio protettivo e, per la categoria di protezione IP64, una guarnizione e un pressacavo metallico (vedi Fig. 1 e Fig. 2).

Preparazione

1. Aprire lo sportello (2) del contenitore con la brugola (1) fornita in dotazione (vedi fig. 2). Conservare la brugola (1) in un posto sicuro.
2. Determinare l'apertura di alimentazione nel contenitore e realizzarla dall'alto o dal basso.

Montaggio

1. Fissare il contenitore a un'altezza di 0,9...1,6 m su una superficie piana.



Osservare le norme nazionali per l'altezza di montaggio esatta!

- Utilizzare solo i fori per viti contrassegnati con la freccia (vedi Fig. 5).
2. Tirare il cavo attraverso i bocchettoni pressacavo forniti in dotazione.
 3. Inserire il cavo nel contenitore attraverso le aperture di alimentazione.
 4. Chiudere lo sportello (2) con la brugola (1).
 5. Se necessario: Incollare un'etichetta autoadesiva 'Rivelatore d'incendio' o 'Vigili del Fuoco' sullo sportello (2) (vedi fig. 2).

Utilizzo in ambienti umidi (categoria di protezione IP64)

- Utilizzare il pressacavo metallico (accessorio).
- Utilizzare una guarnizione DMZ1197-AD (accessorio).
- Chiudere eventuali aperture del contenitore inutilizzate.

Montaggio del coperchio protettivo DMZ1197-AC

1. Aprire lo sportello (2) del contenitore con la brugola (1) fornita in dotazione (vedi fig. 2). Conservare la brugola (1) in un posto sicuro.
2. Rimuovere il componente in vetro.
3. Infilare il coperchio protettivo (3) dal davanti nello sportello (2), passando per l'apertura (fig. 4).
4. Inserire i perni (4) del coperchio protettivo (3) nei due incavi sul retro dello sportello (2).
5. Montare il componente in vetro.
6. Chiudere lo sportello.

Montaggio della guarnizione DMZ1197-AD

1. Con lo sportello (2) aperto, collocare la guarnizione sull'unità interna pulsante montata.
2. Chiudere lo sportello (2) con la brugola (1).

Collegamento elettrico dell'unità interna pulsante

1. Aprire lo sportello (2) del contenitore con la brugola (1).
2. Se i cavi della linea di rivelatori (LINE) sono schermati, collegare le schermature nel contenitore con un morsetto ausiliario (vedi Fig. 5). Se l'indicatore esterno di allarme (AI) viene collegato tramite un cavo schermato, la schermatura deve essere connessa al polo positivo dell'indicatore di allarme con un morsetto ausiliario. Le schermature non devono toccare nessun altro potenziale o parti metalliche all'interno del pulsante manuale.
3. Collegare la linea di alimentazione ai morsetti nell'unità interna pulsante secondo lo schema di collegamento (vedi Fig. 3).



Fare attenzione ai poli positivi e negativi.

Collegare soltanto un filo per ogni morsetto. Solo in questo modo si può garantire un collegamento senza interferenze per l'intera durata utile dell'apparato.

4. Quando si inserisce l'unità interna pulsante nel contenitore, fare attenzione alla linea di alimentazione. Evitare di schiacciare la linea di alimentazione.
5. Inserire l'unità interna pulsante nel contenitore con i morsetti rivolti verso l'alto e fissarla con due viti.



AVVERTENZA!

I pulsanti manuali disattivati non trasmettono gli allarmi

L'allarme non scatta

Contrassegnare i pulsanti manuali disattivati o non funzionali con l'avviso "FUORI SERVIZIO!"



6. Chiudere lo sportello (2) con la brugola (1).

Collegare altre unità interne pulsante allo stesso modo.



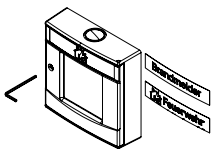
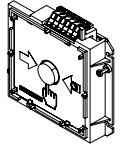
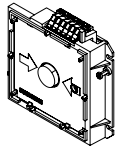
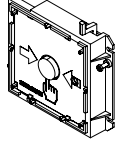
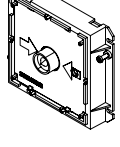
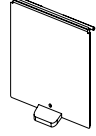
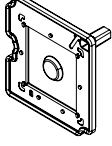
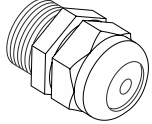

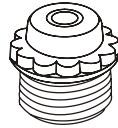
Per maggiori informazioni, si rimanda al documento 007002.

<p>FDMH292-R</p> 	<p>A5Q00005525</p>	<p>en Red 'Heavy Duty' housing, with glass, socket head wrench, 3 cable grippers (2-hole) and self-adhesive 'Fire brigade' and 'Fire detector' labels</p> <p>de Gehäuse rot 'Heavy Duty', mit Glas, Innensechskant-Schlüssel, 3 Würgenippeln (2-Loch) und Selbstklebe-Etiketten 'Feuerwehr' und 'Brandmelder'</p> <p>fr Boîtier rouge 'Heavy Duty' avec verre, clé à six pans creux, 3 manchons à bordure rainurée (à deux orifices) et panneau de fenêtre 'Sapeurs-pompiers' et 'Détecteur incendie'</p> <p>es Carcasa roja 'Heavy Duty' con cristal, llave Allen, 3 racores (2 orificios) y etiquetas autoadhesivas 'Fuerza de Bomberos' y 'Detector de incendios'</p> <p>it Contenitore rosso 'Heavy Duty', con vetrino, brugola, 3 bocchettoni pressacavo (versione a 2 fori) ed etichette autoadesive 'Vigili del Fuoco' e 'Rivelatore d'incendio'</p>
<p>FDME223</p> 	<p>A5Q00003087</p>	<p>en Switching unit for FDM223H</p> <p>de Schaltungseinsatz zu FDM223H</p> <p>fr Unité de commutation FDM223H</p> <p>es Electrónica de pulsador para FDM223H</p> <p>it Unità interna pulsante per FDM223H</p>
<p>FDME224</p> 	<p>A5Q00009392</p>	<p>en Switching unit for FDM224H</p> <p>de Schaltungseinsatz zu FDM224H</p> <p>fr Unité de commutation FDM224H</p> <p>es Electrónica de pulsador para FDM224H</p> <p>it Unità interna pulsante per FDM224H</p>
<p>DMA1103D</p> 	<p>A5Q00004470</p>	<p>en Switching unit for DM1103H</p> <p>de Schaltungseinsatz zu DM1103H</p> <p>fr Unité de commutation DM1103H</p> <p>es Electrónica de pulsador para DM1103H</p> <p>it Unità interna pulsante per DM1103H</p>
<p>DMA1104D</p> 	<p>A5Q00005925</p>	<p>en Switching unit for DM1104H</p> <p>de Schaltungseinsatz zu DM1104H</p> <p>fr Unité de commutation DM1104H</p> <p>es Electrónica de pulsador para DM1104H</p> <p>it Unità interna pulsante per DM1104H</p>
<p>DMZ1197-AC</p> 	<p>BPZ:5223550001</p>	<p>en Protective cover</p> <p>de Schutzdeckel</p> <p>fr Couvercle</p> <p>es Cubierta protectora</p> <p>it Coperchio protettivo</p>
<p>DMZ1197-AD</p> 	<p>BPZ:5470680001</p>	<p>en Protection seal</p> <p>de Dichtung für Nassbereiche</p> <p>fr Joint pour zones humides</p> <p>es Junta para entornos húmedos</p> <p>it Guarnizione per ambienti umidi</p>
<p>-</p> 	<p>A5Q00004478</p>	<p>en Metal cable gland M20 x 1.5</p> <p>de Metall-Kabelverschraubung M20 x 1,5</p> <p>fr Presse-étoupe métallique M20 x 1,5</p> <p>es Prensaestopas metálico para cable M20 x 1,5</p> <p>it Passacavo metallico M20 x 1,5</p>

	A5Q00006735	en Cable gripper M20 x 1.5 (1 hole), red de Würgenippel M20 x 1,5 (1-Loch), rot fr Joint à torsade, M20 x 1,5 (1 trous), rouge es Racor, M20 x 1,5 (1 orificio), rojo it Bocchettone pressacavo M20 x 1,5 (1 foro), rosso
	DMZ1196-AC BPZ:4942050001	en Glass pane de Glasscheibe fr Plaque de verre es Cristal it Lastra di vetro
	BPZ:4074540001	en Auxiliary terminal de Zusatzklemme fr Terminal auxiliaire es Terminal auxiliar it Terminale ausiliario

08  0786	FDM223H	Siemens Switzerland Ltd; Gubelstrasse 22 CH-6301 Zug Technical data: see doc. 007002
FDM223H - Manual callpoint incl. short-circuit isolator for use in fire detection and fire alarm systems installed in buildings.		
305/2011/EU (CPR): EN 54-11 / EN 54-17 ; 2014/30/EU (EMC): EN 50130-4 / EN 61000-6-3 ; 2011/65/EU (RoHS): EN 50581		
The declared performance and conformity can be seen in the Declaration of Performance (DoP) and the EU Declaration of Conformity (DoC), which is obtainable via the Customer Support Center: Tel. +49 89 9221-8000 or http://siemens.com/bt/download		
DoP No.: 0786-CPR-20444; DoC No.: CED-FDM223H		

07  0786	FDM224H	Siemens Switzerland Ltd; Gubelstrasse 22 CH-6301 Zug Technical data: see doc. 007002
FDM224H - Manual callpoint incl. short-circuit isolator for use in fire detection and fire alarm systems installed in buildings.		
305/2011/EU (CPR): EN 54-11 / EN 54-17 ; 2014/30/EU (EMC): EN 50130-4 / EN 61000-6-3 ; 2011/65/EU (RoHS): EN 50581		
The declared performance and conformity can be seen in the Declaration of Performance (DoP) and the EU Declaration of Conformity (DoC), which is obtainable via the Customer Support Center: Tel. +49 89 9221-8000 or http://siemens.com/bt/download		
DoP No.: 0786-CPR-20370; DoC No.: CED-FDM224H		

08  0786	DM1103H	Siemens Switzerland Ltd; Gubelstrasse 22 CH-6301 Zug Technical data: see doc. 001720
DM1103H - Manual callpoint for use in fire detection and fire alarm systems installed in buildings.		
305/2011/EU (CPR): EN 54-11 ; 2014/30/EU (EMC): EN 50130-4 / EN 61000-6-3 ; 2011/65/EU (RoHS): EN 50581		
The declared performance and conformity can be seen in the Declaration of Performance (DoP) and the EU Declaration of Conformity (DoC), which is obtainable via the Customer Support Center: Tel. +49 89 9221-8000 or http://siemens.com/bt/download		
DoP No.: 0786-CPR-20269; DoC No.: CED-DM1103H		

08  0786	DM1104H	Siemens Switzerland Ltd; Gubelstrasse 22 CH-6301 Zug Technical data: see doc. 001721
DM1104H - Manual callpoint for use in fire detection and fire alarm systems installed in buildings.		
305/2011/EU (CPR): EN 54-11 ; 2014/30/EU (EMC): EN 50130-4 / EN 61000-6-3 ; 2011/65/EU (RoHS): EN 50581		
The declared performance and conformity can be seen in the Declaration of Performance (DoP) and the EU Declaration of Conformity (DoC), which is obtainable via the Customer Support Center: Tel. +49 89 9221-8000 or http://siemens.com/bt/download		
DoP No.: 0786-CPR-20270; DoC No.: CED-DM1104H		

08  0786	DM1133H	Siemens Switzerland Ltd; Gubelstrasse 22 CH-6301 Zug Technical data: see doc. 001720
DM1133H - Manual callpoint incl. short-circuit isolator for use in fire detection and fire alarm systems installed in buildings.		
305/2011/EU (CPR): EN 54-11 / EN 54-17 ; 2014/30/EU (EMC): EN 50130-4 / EN 61000-6-3		
The declared performance and conformity can be seen in the Declaration of Performance (DoP) and the EU Declaration of Conformity (DoC), which is obtainable via the Customer Support Center: Tel. +49 89 9221-8000 or http://siemens.com/bt/download		
DoP No.: 0786-CPR-20271; DoC No.: CED-DM1133H		

08  0786	DM1134H	Siemens Switzerland Ltd; Gubelstrasse 22 CH-6301 Zug Technical data: see doc. 001721
DM1134H - Manual callpoint incl. short-circuit isolator for use in fire detection and fire alarm systems installed in buildings.		
305/2011/EU (CPR): EN 54-11 / EN 54-17 ; 2004/108/EC (EMC): EN 50130-4 / EN 61000-6-3		
The declared performance and conformity can be seen in the Declaration of Performance (DoP) and the EU Declaration of Conformity (DoC), which is obtainable via the Customer Support Center: Tel. +49 89 9221-8000 or http://siemens.com/bt/download		
DoP No.: 0786-CPR-20272; DoC No.: CED-DM1134, CED-DM1134H		

08  0786	DM1153H	Siemens Switzerland Ltd; Gubelstrasse 22 CH-6301 Zug Technical data: see doc. 001720
DM1153H - Manual callpoint for use in fire detection and fire alarm systems installed in buildings.		
305/2011/EU (CPR): EN 54-11 / EN 54-17 ; 2004/108/EC (EMC): EN 50130-4 / EN 61000-6-3		
The declared performance and conformity can be seen in the Declaration of Performance (DoP) and the EU Declaration of Conformity (DoC), which is obtainable via the Customer Support Center: Tel. +49 89 9221-8000 or http://siemens.com/bt/download		
DoP No.: 0786-CPR-20273; DoC No.: CED-DM1153, CED-DM1153H		

08  0786	DM1153H-Ex	Siemens Switzerland Ltd, Gubelstrasse 22 CH-6301 Zug Technical data: see doc. x1837
DM1153H-Ex - Manual callpoint for use in fire detection and fire alarm systems installed in buildings.		
305/2011/EU (CPR): EN 54-11 ; 2014/30/EU (EMC): EN 50130-4 / EN 61000-6-3 ; 2014/34/EU (ATEX): EN 60079-0 / EN 60079-11		
The declared performance and conformity can be seen in the Declaration of Performance (DoP) and the EU Declaration of Conformity (DoC), which is obtainable via the Customer Support center: Tel. +49 89 9221-8000 or http://siemens.com/bt/download		
DoP No.: 0786-CPR-20274; DoC No.: CED-DM1153H-Ex		

08  0786	DM1154H	Siemens Switzerland Ltd; Gubelstrasse 22 CH-6301 Zug Technical data: see doc. 001721
DM1154H - Manual callpoint for use in fire detection and fire alarm systems installed in buildings.		
305/2011/EU (CPR): EN 54-11 / EN 54-17 ; 2004/108/EC (EMC): EN 50130-4 / EN 61000-6-3		
The declared performance and conformity can be seen in the Declaration of Performance (DoP) and the EU Declaration of Conformity (DoC), which is obtainable via the Customer Support Center: Tel. +49 89 9221-8000 or http://siemens.com/bt/download		
DoP No.: 0786-CPR-20275; DoC No.: CED-DM1154H		

08  0786	DM1154H-Ex	Siemens Switzerland Ltd; Gubelstrasse 22 CH-6301 Zug Technical data: see doc. x1837
DM1154H-Ex - Manual callpoint for use in fire detection and fire alarm systems installed in buildings.		
305/2011/EU (CPR): EN 54-11 ; 2014/30/EU (EMC): EN 50130-4 / EN 61000-6-3		
The declared performance and conformity can be seen in the Declaration of Performance (DoP) and the EU Declaration of Conformity (DoC), which is obtainable via the Customer Support Center: Tel. +49 89 9221-8000 or http://siemens.com/bt/download		
DoP No.: 0786-CPR-20276; DoC No.: CED-DM1154H-Ex		

Issued by
Siemens Switzerland Ltd
Building Technologies Division
International Headquarters
Gubelstrasse 22
CH-6301 Zug
Tel. +41 41 – 724 24 24
www.siemens.com/buildingtechnologies

© Siemens Switzerland Ltd, 2005
Technical specifications and availability subject to change without notice.