

| | | |
|-----------|-----------------------------|----------------|
| | FDCIO222 / FDCIO224 | FDCH221 |
| en | Input/output module | Housing |
| de | Ein-/Ausgabebaustein | Gehäuse |
| fr | Interface d'entrées/sorties | Boîtier |
| es | Módulo de entrada/salida | Carcasa |
| it | Modulo in/out digitali | Contentitore |

en Installation
de Montage
fr Montage
es Montaje
it Montaggio

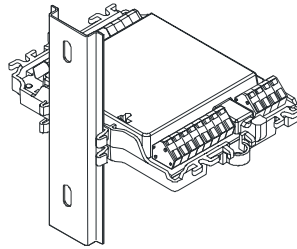

Fig. 1

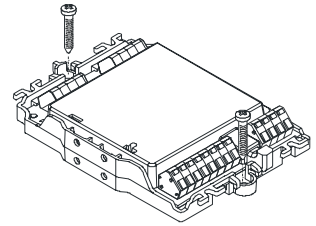

Fig. 2

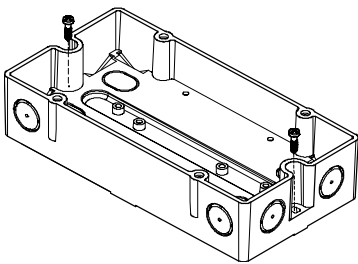

Fig. 3

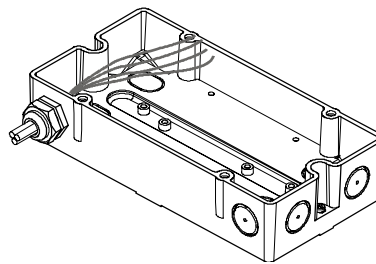

Fig. 4

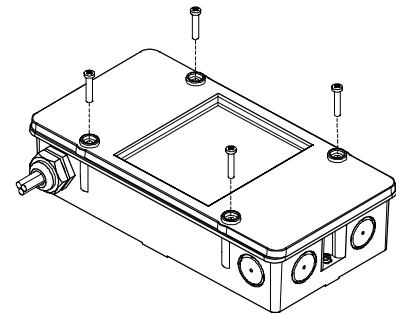

Fig. 5

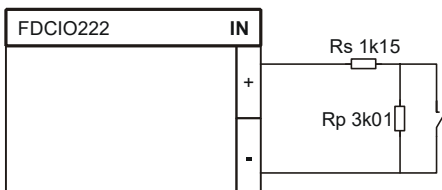

Fig. 6

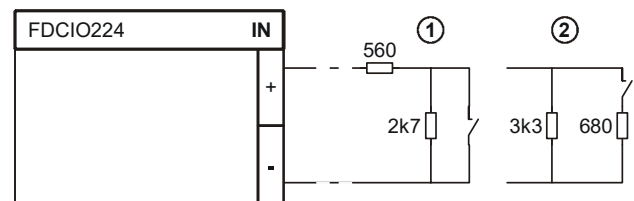

Fig. 7

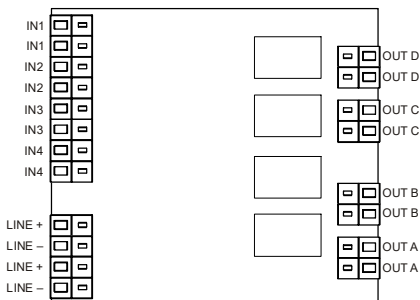

Fig. 8

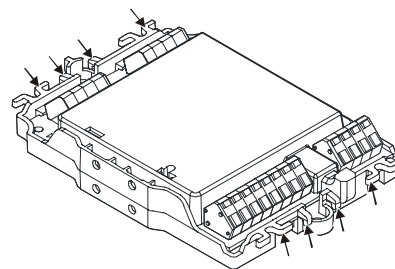



Fig. 9

Intended use

The input/output module can use the outputs for control purposes and the inputs to monitor the statuses of potential-free contacts. A housing is available to protect the module from environmental influences or danger caused by electrical voltage.

| | |
|---|--|
|  | <p>DANGER</p> <p>Voltage levels of up to 250 V AC may occur on the module's terminals!</p> <p>Danger to life through contact with live components!</p> <ul style="list-style-type: none"> • Use the housing FDCH221 if switching outputs of voltages >60 VDC (ripple <10 % of average value) or >30 VAC (peak value max. 42.4 V). • Ensure that the cables are not supplied with voltage during installation. |
|---|--|

Preparation

The installation procedure depends on the module's site of use and type of installation.

1. Define the place of use.
 - Installation outside a switch cabinet
 - Installation in a switch cabinet

| | |
|---|--|
|  | <p>The output lines of the input/output module are not monitored! In order to implement fire controls complying with VdS, the input/output module must be installed in the fire control housing.</p> |
|---|--|

2. Define the type of installation.
 - In housing FDCH221 (Fig. 5)
 - On a top hat rail (Fig. 1)
 - On a plane surface (Fig. 2)

Installation in housing

| | |
|---|--|
|  | <p>NOTICE</p> <p>Module use in a damp, wet or dusty environment</p> <p>Damage to module from dust or jet of water</p> <ul style="list-style-type: none"> • In damp, wet or dusty environments, fit the module in a housing FDCH221. |
|---|--|

1. Open housing (Fig. 5).
2. Determine cable entries in housing and break them open.
3. Use two screws to fit the housing on a plane surface (Fig. 3).
4. Secure the M20 x 1.5 cable glands on the housing and guide in the cables (Fig. 4).

5. Use two M3 x 12 screws to fit the module in the housing (Fig. 2).

6. Close housing using supplied screws (Fig. 5).

Install input/output module on a top hat rail

| | |
|---|--|
|  | <p>NOTICE</p> <p>High temperatures in the module's environment</p> <p>Module overheating and damage</p> <ul style="list-style-type: none"> • A minimum clearance of 1 cm must be observed between two modules or between the module and any other boundary. |
|---|--|

1. Insert two mounting feet into the input/output module.
2. Push the input/output module with the mounting feet against the top hat rail until the mounting feet engage (Fig. 1).

Install input/output module on a plane surface

| | |
|---|--|
|  | <p>NOTICE</p> <p>High temperatures in the module's environment</p> <p>Module overheating and damage</p> <ul style="list-style-type: none"> • A minimum clearance of 1 cm must be observed between two modules or between the module and any other boundary. |
|---|--|

1. Secure input/output module with two screws on a plane surface (Fig. 2).

Electrical connection

1. Connect the cables to the terminals (Fig. 8).

| | |
|---|---|
|  | <p>Note the positive and negative poles.</p> <p>Only connect one wire per terminal. This is the only way of ensuring a problem-free connection over the device's entire service life.</p> |
|---|---|

2. If using shielded cables:
 - Use connection terminals DBZ1190-AB (accessories) and connect shielding to connection terminals. The shielding must not touch any extrinsic potentials to ground or metal parts in the device.
3. Connect resistors to input terminals (Fig. 6 and Fig. 7).
 - The resistors must be connected at the end of the line!
4. Secure cables on module with cable ties (Fig. 9).

| | |
|---|--|
|  | <p>For more information see document 007023.</p> |
|---|--|

Verwendungszweck

Der Ein-/Ausgabebaustein kann mit den Ausgängen Steuerungen vornehmen und mit den Eingängen Zustände von potenzialfreien Kontakten überwachen. Für den Schutz vor Umwelteinflüssen oder Gefahren durch elektrische Spannung steht ein Gehäuse zu Verfügung.

| | |
|---|--|
|  | <p>GEFAHR</p> <p>An den Klemmen des Bausteins können Spannungen bis zu 250 VAC auftreten! Lebensgefahr durch Kontakt mit stromführenden Bauteilen!</p> <ul style="list-style-type: none"> • Verwenden Sie das Gehäuse FDCH221, wenn Sie an den Ausgängen Spannung >60 VDC (Welligkeit <10 % vom Mittelwert) oder >30 VAC (Scheitelwert max. 42,4 V) schalten. • Stellen Sie sicher, dass während der Installation keine Spannung an den Leitungen anliegt. |
|---|--|

Vorbereitung

Das Vorgehen bei der Installation hängt vom Einsatzort und der Montageart des Bausteins ab.

- Bestimmen Sie den Einsatzort.
 - Montage außerhalb eines Schaltschranks
 - Montage in einem Schaltschrank

| | |
|---|--|
|  | <p>Die Leitungen der Ausgänge des Ein-/Ausgabebausteins sind nicht überwacht! Für die Realisierung von VdS-konformen Brandfallsteuerungen, muss der Ein-/Ausgabebaustein in das Gehäuse der Brandfallsteuerung eingebaut werden.</p> |
|---|--|

- Bestimmen Sie die Montageart:
 - Im Gehäuse FDCH221 (Fig. 5)
 - Auf einer Hutschiene (Fig. 1)
 - Auf einer planen Oberfläche (Fig. 2)

Montage im Gehäuse

| | |
|---|--|
|  | <p>HINWEIS</p> <p>Einsatz des Bausteins in feuchter, nasser oder staubiger Umgebung Beschädigung des Bausteins durch Staub oder Strahlwasser</p> <ul style="list-style-type: none"> • Montieren Sie den Baustein in feuchter, nasser oder staubiger Umgebung in ein Gehäuse FDCH221. |
|---|--|

- Öffnen Sie das Gehäuse (Fig. 5).
- Bestimmen Sie die Kabeleinführungen im Gehäuse und brechen Sie diese aus.
- Montieren Sie das Gehäuse mit zwei Schrauben auf eine plane Fläche (Fig. 3).
- Befestigen Sie die Kabelverschraubungen M20 x 1,5 am Gehäuse und führen Sie die Kabel ein (Fig. 4).

- Montieren Sie den Baustein mit zwei Schrauben M3 x 12 im Gehäuse (Fig. 2).
- Schließen Sie das Gehäuse mit den mitgelieferten Schrauben (Fig. 5).

Ein-/Ausgabebaustein auf eine Hutschiene montieren

| | |
|---|--|
|  | <p>HINWEIS</p> <p>Hohe Temperaturen in der Umgebung des Bausteins Überhitzung und Beschädigung des Bausteins</p> <ul style="list-style-type: none"> • Zwischen zwei Bausteinen oder einer anderen Begrenzung muss mindestens 1 cm Freiraum vorhanden sein. |
|---|--|

- Stecken Sie zwei Montagefüsse in den Ein-/Ausgabebaustein.
- Drücken Sie den Ein-/Ausgabebaustein mit den Montagefüssen gegen die Hutschiene, bis diese einrasten (Fig. 1).

Ein-/Ausgabebaustein auf eine plane Oberfläche montieren

| | |
|---|--|
|  | <p>HINWEIS</p> <p>Hohe Temperaturen in der Umgebung des Bausteins Überhitzung und Beschädigung des Bausteins</p> <ul style="list-style-type: none"> • Zwischen zwei Bausteinen oder einer anderen Begrenzung muss mindestens 1 cm Freiraum vorhanden sein. |
|---|--|

- Befestigen Sie den Ein-/Ausgabebaustein mit zwei Schrauben auf einer planen Oberfläche (Fig. 2).

Elektrischer Anschluss

- Schließen Sie die Kabel an den Klemmen an (Fig. 8).

| | |
|---|--|
|  | <p>Beachten Sie die Plus- und Minus-Anschlüsse. Schließen Sie pro Klemme nur einen Draht an. Nur so kann ein störungsfreier Anschluss über die gesamte Lebensdauer des Gerätes gewährleistet werden.</p> |
|---|--|

- Falls Sie Kabel mit Abschirmung verwenden: Verwenden Sie Verbindungsklemmen DBZ1190-AB (Zubehör) und schließen Sie die Abschirmung an den Verbindungsklemmen an. Die Abschirmung darf keine fremden Erdpotenziale oder Metallteile im Gerät berühren.
- Schließen Sie die Widerstände an den Klemmen der Eingänge an (Fig. 6 und Fig. 7). Die Widerstände müssen am Ende der Leitung angeschlossen werden!
- Befestigen Sie die Kabel mit Kabelbindern am Baustein (Fig. 9).

| | |
|---|---|
|  | <p>Weitere Informationen siehe Dokument 007023.</p> |
|---|---|

Application

L'interface d'entrées/sorties peut exécuter des commandes avec les sorties et surveiller les états de contacts exempts de potentiel grâce aux entrées. Un boîtier est à disposition pour la protection contre les influences de l'environnement ou les dangers dus à la tension électrique.

| | |
|---|---|
|  | <p>DANGER</p> <p>Au niveau des bornes du module, des tensions jusqu'à 250 V AC peuvent être générées !</p> <p>Danger de mort par contact avec des éléments conducteurs !</p> <ul style="list-style-type: none"> • Utilisez le boîtier FDCH221 lorsque la tension est >60 VDC (ondulation <10 % de la moyenne) ou >30 VAC (amplitude de 42,4 V max.) commutent aux sorties. • Assurez-vous qu'aucune tension n'est présente sur les câbles durant l'installation. |
|---|---|

Préparation

La procédure au niveau de l'installation dépend du site d'exploitation et du type d'installation du module.

1. Déterminer le lieu d'exploitation.
 - Montage à l'extérieur d'une armoire de commande
 - Montage dans une armoire de commande

| | |
|---|--|
|  | <p>Les câbles de sorties de l'interface d'entrées/sorties ne sont pas surveillés ! Pour la réalisation de commandes relatives à l'incendie conformes VdS, l'interface d'entrées/sorties doit être montée dans le boîtier de la commande relative à l'incendie.</p> |
|---|--|

2. Déterminez le type d'installation :
 - Dans le boîtier FDCH221 (fig. 5)
 - Sur un profilé (fig. 1)
 - Sur une surface plane (fig. 2)

Installation dans le boîtier

| | |
|---|--|
|  | <p>AVIS</p> <p>Utilisation du module dans un environnement humide, très humide ou poussiéreux</p> <p>Endommagement du module par la poussière ou les projections d'eau</p> <ul style="list-style-type: none"> • Montez le module dans un boîtier FDCH221 en environnement humide, très humide ou poussiéreux. |
|---|--|

1. Ouvrez le boîtier (fig. 5).
2. Déterminez les entrées de câbles dans le boîtier et dégagez-les.
3. Montez le boîtier sur une surface plane avec deux vis (fig. 3).
4. Fixez les presse-étoupe M20 x 1,5 sur le boîtier et introduisez les câbles (fig. 4).

5. Montez le module dans le boîtier avec deux vis M3 x 12 (fig. 2).
6. Fermez le boîtier avec les deux vis fournies lors de la livraison (fig. 5).

Monter une interface d'entrées/sorties sur un profilé

| | |
|---|---|
|  | <p>AVIS</p> <p>Températures élevées autour du module</p> <p>Surchauffe et endommagement du module</p> <ul style="list-style-type: none"> • Il convient de toujours laisser un espace d'au moins 1 cm entre deux modules ou une autre délimitation. |
|---|---|

1. Insérez deux ergots de montage dans l'interface d'entrées/sorties.
2. Poussez l'interface d'entrées/sorties avec les pieds de montage contre le profilé jusqu'à ce que les pieds s'enclenchent (fig. 1).

Monter une interface d'entrées/sorties sur une surface plate

| | |
|---|---|
|  | <p>AVIS</p> <p>Températures élevées autour du module</p> <p>Surchauffe et endommagement du module</p> <ul style="list-style-type: none"> • Il convient de toujours laisser un espace d'au moins 1 cm entre deux modules ou une autre délimitation. |
|---|---|

1. Fixez l'interface d'entrées/sorties sur une surface plate à l'aide de deux vis (fig. 2).

Raccordement électrique

1. Raccordez les câbles aux bornes (fig. 8).

| | |
|---|--|
|  | <p>Veillez à porter attention aux pôles positifs et négatifs.</p> <p>Ne raccordez qu'un fil par borne. C'est la seule manière de garantir un raccordement sans perturbation pendant toute la durée de vie de l'appareil.</p> |
|---|--|

2. Si vous utilisez un câble avec écran :
Utilisez les borniers DBZ1190-AB (accessoires) et raccordez l'écran sur les borniers. L'écran ne doit être en contact avec aucun autre potentiel de terre ni aucune pièce métallique dans l'appareil.
3. Raccordez les résistances aux borniers des entrées (fig. 6 et fig. 7). Les résistances doivent être raccordées à l'extrémité du câble !
4. Fixez les câbles sur le module avec des serre-câbles (fig. 9).

| | |
|---|--|
|  | <p>Pour de plus amples informations, voir document 007023.</p> |
|---|--|

Uso previsto

Con las salidas, el módulo de entrada/salida puede realizar funciones de control y con las entradas, monitorizar los estados de contactos sin potencial. Para la protección contra factores ambientales o peligros por tensión eléctrica se dispone de una carcasa.

| | |
|---|---|
|  | <p>PELIGRO</p> <p>¡En los terminales del módulo puede haber tensiones de hasta 250 VAC!</p> <p>¡Peligro de muerte por contacto con elementos conductores de corriente!</p> <ul style="list-style-type: none"> • Utilice la carcasa FDCH221 si en las salidas se conmuta una tensión >60 VDC (ondulación <10 % del valor medio) o >30 VAC (valor de cresta máx. 42,4 V). • Cerciórese de que durante la instalación no hay tensión aplicada a los cables. |
|---|---|

Preparativos

El procedimiento durante la instalación depende del lugar de instalación y del tipo de montaje del módulo.

1. Determine el lugar de montaje.
 - Montaje fuera de un armario de distribución
 - Montaje en un armario de distribución

| | |
|---|--|
|  | <p>¡Los cables de las salidas del módulo de entrada/salida no están monitorizados! Para la realización de controles de incendio conforme a VdS, el módulo de entrada/salida debe instalarse en la carcasa del control de incendio.</p> |
|---|--|

2. Determine el tipo de montaje:
 - En la carcasa FDCH221 (Fig. 5)
 - En un carril DIN (Fig. 1)
 - Sobre una superficie plana (Fig. 2)

Montaje en la carcasa

| | |
|---|--|
|  | <p>AVISO</p> <p>Empleo del módulo en un entorno húmedo, mojado o polvoriento</p> <p>Daños en el módulo por polvo o chorros de agua</p> <ul style="list-style-type: none"> • En un entorno húmedo, mojado o polvoriento, monte el módulo en una carcasa FDCH221. |
|---|--|

1. Abra la carcasa (Fig. 5).
2. Determine las entradas de cable en la carcasa y rómpalas.
3. Monte la carcasa con dos tornillos sobre una superficie plana (Fig. 3).
4. Fije los prensaestopas para cable M20 x 1,5 en la carcasa e introduzca los cables (Fig. 4).

5. Monte el módulo con dos tornillos M3 x 12 en la carcasa (Fig. 2).
6. Cierre la carcasa con los tornillos suministrados (Fig. 5).

Montar el módulo de entrada/salida en un carril DIN

| | |
|---|--|
|  | <p>AVISO</p> <p>Altas temperaturas en el entorno del módulo</p> <p>Sobrecalentamiento del módulo y daños en el mismo</p> <ul style="list-style-type: none"> • Entre dos módulos u otra limitación siempre debe haber un espacio libre mínimo de 1 cm. |
|---|--|

1. Inserte dos pies de montaje en el módulo de entrada/salida.
2. Presione el módulo de entrada/salida con los pies de montaje contra el carril DIN hasta que encajen los pies (Fig. 1).

Montar el módulo de entrada/salida en una superficie plana

| | |
|---|--|
|  | <p>AVISO</p> <p>Altas temperaturas en el entorno del módulo</p> <p>Sobrecalentamiento del módulo y daños en el mismo</p> <ul style="list-style-type: none"> • Entre dos módulos u otra limitación siempre debe haber un espacio libre mínimo de 1 cm. |
|---|--|

1. Sujete el módulo de entrada/salida con dos tornillos en una superficie plana (Fig. 2).

Conexión eléctrica

1. Conecte los cables en los terminales (Fig. 8).

| | |
|---|---|
|  | <p>Observe los polos positivos y negativos. Conecte únicamente un hilo por terminal. Sólo así podrá garantizarse una conexión sin fallos durante la vida útil completa del dispositivo.</p> |
|---|---|

2. Si utiliza cables apantallados:
 - Utilice terminales de conexión DBZ1190-AB (accesorios) y conecte el apantallamiento en los terminales de conexión. El apantallamiento no debe tocar ningún potencial de tierra externo ni piezas de metal en el dispositivo.
3. Conecte las resistencias a los terminales de las entradas (Fig. 6 y Fig. 7). ¡Las resistencias deben conectarse en el extremo de la línea!
4. Fije los cables con sujetacables en el módulo (Fig. 9).

| | |
|---|--|
|  | <p>Para más información, consulte el documento 007023.</p> |
|---|--|

Destinazione d'uso

Il modulo in/out digitali può adempiere a funzioni di comando mediante le uscite e può monitorare lo stato di contatti a potenziale zero mediante gli ingressi. È disponibile un contenitore al fine di proteggere il modulo da influssi ambientali o da pericoli derivanti da tensione elettrica.

**PERICOLO**

Sui morsetti del modulo possono essere presenti tensioni fino a 250 VCA.

Pericolo di morte per il contatto con componenti sotto tensione!

- Utilizzare il contenitore FDCH221 alle uscite vengono collegate tensioni >60 VCC (ondulazione <10 % dal valore medio) oppure >30 VCA (valore di picco max 42,4 V).
- Assicurare che durante l'installazione non sia presente tensione sulle linee.

Preparazione

La procedura in fase di installazione dipende dal luogo di installazione e dal tipo di montaggio del modulo.

1. Determinare la sede di utilizzo.
 - Montaggio al di fuori di un armadio elettrico
 - Montaggio in un armadio elettrico



Le linee delle uscite del modulo in/out digitali non sono monitorate! Per la realizzazione di comandi incendio in conformità alle direttive VdS, il modulo in/out digitali deve essere montato nel contenitore del comando incendio.

2. Stabilire il tipo di montaggio:
 - All'interno del contenitore FDCH221 (Fig. 5)
 - Su una guida a cappello (Fig. 1)
 - Su una superficie piana (Fig. 2)

Montaggio nel contenitore**AVVISO**

Impiego del moduli in ambiente umido, bagnato o polveroso

Danneggiamento del modulo causato da polvere o getti d'acqua

- In ambiente umido, bagnato o polveroso, montare il modulo in un contenitore FDCH221.

1. Aprire il contenitore (Fig. 5).
2. Individuare i punti di entrata dei cavi nel contenitore e aprirli.
3. Montare il contenitore con due viti su una superficie piana (Fig. 3).
4. Fissare i pressacavi M20 x 1,5 al contenitore e introdurre i cavi (Fig. 4).

5. Montare il separatore di linea multiplo nel contenitore (Fig. 2) con due viti M3 x 12.

6. Fissare il contenitore con le viti fornite in dotazione (Fig. 5).

Montaggio del modulo in/out digitali su guida a cappello**AVVISO**

Temperature elevate nella zona del modulo

Surriscaldamento e danneggiamento del modulo

- Tra due moduli o un'altra limitazione deve essere presente uno spazio libero di almeno 1 cm.

1. Inserire due piedini di montaggio nel modulo in/out digitali.
2. Premere il modulo in/out digitali unitamente ai piedini di montaggio contro la guida a cappello finché non scatta in posizione (Fig. 1).

Montaggio del modulo in/out digitale su una superficie piana**AVVISO**

Temperature elevate nella zona del modulo

Surriscaldamento e danneggiamento del modulo

- Tra due moduli o un'altra limitazione deve essere presente uno spazio libero di almeno 1 cm.

1. Fissare il modulo in/out digitali su una superficie piana utilizzando due viti (Fig. 2).

Collegamento elettrico

1. Collegare i cavi ai morsetti (Fig. 8).



Fare attenzione ai poli positivi e negativi.

Collegare un solo filo per morsetto. Solo così può essere garantito un collegamento corretto durante l'intero ciclo di vita dell'apparato.

2. Se si utilizzano cavi schermati: utilizzare morsettiere ausiliarie DBZ1190-AB (accessorio) e collegare le schermature con le morsettiere ausiliarie DBZ1190-AB. La schermatura non può entrare in contatto con potenziali di terra esterni o parti metalliche all'interno dell'apparecchio.
3. Collegare le resistenze ai morsetti degli ingressi (Fig. 6 e Fig. 7). Le resistenze devono essere collegate all'estremità della linea!
4. Fissare i cavi sul modulo tramite fascette serracavi (Fig. 9).

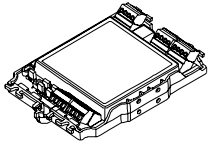
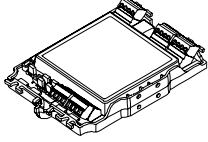
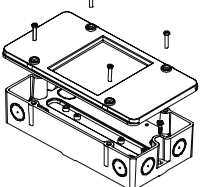
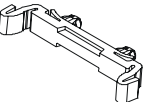
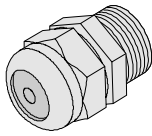
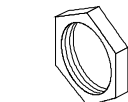

Per ulteriori informazioni consultare il documento 007023.

| | | |
|---|----------------|--|
| FDCIO222 | A5Q00002369 | <p>en Input/Output module</p> <p>de Ein-/Ausgabebaustein</p> <p>fr Interface d'entrées / sorties</p> <p>es Módulo de entrada/salida</p> <p>it Modulo in/out digitali</p> |
|  | | |
| FDCIO224 | A5Q00018689 | <p>en Input/Output module</p> <p>de Ein-/Ausgabebaustein</p> <p>fr Interface d'entrées / sorties</p> <p>es Módulo de entrada/salida</p> <p>it Modulo in/out digitali</p> |
|  | | |
| FDCH221 | S54312-F3-A1 | <p>en Housing</p> <p>de Gehäuse</p> <p>fr Boîtier</p> <p>es Carcasa</p> <p>it Contenitore</p> |
|  | | |
| FDCM291 | A5Q00003855 | <p>en Mounting foot</p> <p>de Montagefuss</p> <p>fr Pied de montage</p> <p>es Pie de montaje</p> <p>it Piedino di montaggio</p> |
|  | | |
| --- | A5Q00004478 | <p>en Metal cable gland M20 x 1.5</p> <p>de Metall-Kabelverschraubung M20 x 1,5</p> <p>fr Presse-étoupe métallique M20 x 1,5</p> <p>es Prensaestopas metálico para cable M20 x 1,5</p> <p>it Pressacavo metallico M20 x 1,5</p> |
|  | | |
| --- | A5Q00004479 | <p>en Counter nut M20 x 1.5</p> <p>de Gegenmutter M20 x 1,5</p> <p>fr Contre-écrou M20 x 1,5</p> <p>es Contratuerca M20 x 1,5</p> <p>it Controdado M20 x 1,5</p> |
|  | | |
| --- | BPZ:1825330001 | <p>en Cable tie 2.4 x 137 POLYAMID</p> <p>de Kabelbinder 2,4 x 137 POLYAMID</p> <p>fr Serre-câble 2,4 x 137 POLYAMID</p> <p>es Sujetacables 2,4 x 137 POLIAMIDA</p> <p>it Fermacavo 2,4 x 137 POLIAMMIDE</p> |
| | | |
| --- | BPZ:2567860001 | <p>en Resistor Rp 3k01; 1 %; 0.25 W</p> <p>de Widerstand Rp 3k01; 1 %; 0,25 W</p> <p>fr Résistance Rp 3k01; 1 %; 0,25 W</p> <p>es Resistencia Rp 3k01; 1 %; 0,25 W</p> <p>it Resistenza Rp 3k01; 1 %; 0,25 W</p> |
| | | |

| | | | |
|-----|----------------|-----------|---|
| --- | BPZ:3383580001 | en | Resistor Rs 1k15; 1 %; 0.25 W |
| | | de | Widerstand Rs 1k15; 1 %; 0,25 W |
| | | fr | Résistance Rs 1k15; 1 %; 0,25 W |
| | | es | Resistencia Rs 1k15; 1 %; 0,25 W |
| | | it | Resistenza Rs 1k15; 1 %; 0,25 W |
| --- | A5Q0000944 | en | Resistor 2k7; 1 %; 0.35 W (FDCIO224) |
| | | de | Widerstand 2k7; 1 %; 0,35 W (FDCIO224) |
| | | fr | Résistance 2k7; 1 %; 0,35 W (FDCIO224) |
| | | es | Resistencia 2k7; 1 %; 0,35 W (FDCIO224) |
| | | it | Resistenza 2k7; 1 %; 0,35 W (FDCIO224) |
| --- | A5Q00014012 | en | Resistor 560; 1 %; 0.25 W (FDCIO224) |
| | | de | Widerstand 560; 1 %; 0,25 W (FDCIO224) |
| | | fr | Résistance 560; 1 %; 0,25 W (FDCIO224) |
| | | es | Resistencia 560; 1 %; 0,25 W (FDCIO224) |
| | | it | Resistenza 560; 1 %; 0,25 W (FDCIO224) |

DBZ1190-AB

BPZ:4942340001

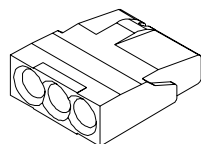

| | |
|-----------|--|
| en | Connection terminal 0.5...2.5 mm ² |
| de | Verbindungsklemme 0,5...2,5 mm ² |
| fr | Bornier 0,5...2,5 mm ² |
| es | Terminal de conexión 0,5...2,5 mm ² |
| it | Morsetto di collegamento 0,5...2,5 mm ² |



007023



siemens.com



downloads.siemens.com

FDCIO222
FDCIO224