

TX-I/O™

## Power supply module, TXS1.12F10 bus connection module TXS1.EF10

- Each I/O row begins with one of these devices
- TXS1.12F10 power supply module
  - Up to 4 power supply modules can be operated in parallel
  - AC 24 V input
  - Generation / transfer of DC 24 V, 1.2A for the supply of TX-I/O modules and field devices
  - Fresh provision of AC 24 V for field device supply
  - Transfer of the bus signal
- TXS1.EF10 bus connection module
  - Transfer of DC 24 V for the supply of TX-I/O modules and field devices
  - Fresh provision of AC / DC 12 ... 24 V for field device supply
  - Transfer of the bus signal
- Compact format (to DIN43 880), small footprint
- Simple installation and easy access
  - Self-establishing bus connection for maximum ease of installation
  - Plug-in screw terminals
  - Fuse is accessible with device installed
- Easy, fast diagnostics

## Function

---

Each I/O row starts with a power supply module, or a bus connection module (or a P-Bus interface module, see data sheet CM2N8180). These devices are connected via terminals, and they supply the I/O modules with the following (via island bus):

**TXM1.12F10**  
**Power supply module**

- DC 24 V for the supply of I/O modules and field devices (generated in an internal AC/DC converter)
- AC 24 V for the supply of field devices
- the bus signal

**TXM1.EF10**  
**Bus connection module**

- AC / DC 12 ... 24 V for the supply of field devices
- the bus signal

## Type summary

---

**ASN**                      Power supply module    **TXM1.12F10**  
                                 Bus connection module   **TXM1.EF10**

**Items supplied**                      Module with 3 bus-connector covers  
(1 for left end of I/O bar, 1 for right end and 1 spare)

## Ordering

---

When ordering, please specify the quantity, product name and type code.

*Example:*

10      Power supply modules                      **TXS1.12F10**

## Compatibility

---

TXM1.12F10 power supply modules and the TXM1.EF10 bus connection modules are suitable for use with all TX-I/O™ devices.

Overview

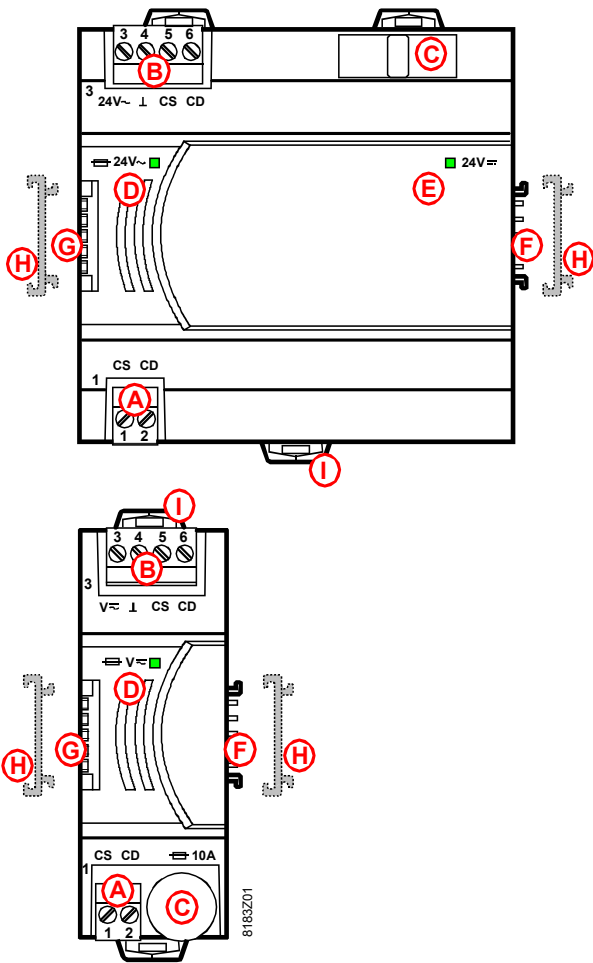

Key

- A Plug-in screw terminal ("1")
  - 1 CS DC 24 V supply for modules and field devices
  - 2 CD Island bus signal
- B Plug-in screw terminal ("3")
  - 3 24V~ Supply for supply module and Field devices (TXS1.12F10)
  - 4 ⊥ System neutral
  - 5 CS DC 24 V module supply
  - 6 CD Island bus signal
- C Fuse, T 10A for field supply
- D LED: "Field supply OK"
- E LED "DC 24 V module supply OK"
- F Bus connector (right) (with field device supply)
- G Bus connector (left) (no field device supply)
- H Bus connector cover
- I Slide fitting for standard mounting rail

Mechanical characteristics

Housing

- The housing complies with DIN 43880 and is 90mm wide.
- The plastic housing is provided with a large number of vents for cooling
- When mounting, allow for sufficient heat dissipation by convection (max. ambient temperature 50°C)

## Electrical characteristics

TXS1.12F10 supply module)	<ul style="list-style-type: none"><li>• The supply module is supplied with AC 24 V. The tolerance range is <math>-10 \dots +20\%</math>.</li><li>• The device generates a supply voltage of DC 24 V ("Module supply 24V=") for the modules and field devices, designed for a current rating of 1.2 A.</li><li>• The power supply module is short-circuit proof.</li><li>• Parallel operation is permissible as follows:<ul style="list-style-type: none"><li>– A maximum of 4 power supply modules can be operated in parallel</li><li>– However, each I/O bar can accommodate a maximum of 2 power supply modules (see [3])</li></ul></li><li>• To supply the field devices, the AC 24 V supply voltage is connected via a T 10A fuse to the island bus ("Field supply 24V~", maximum admissible current 6 A). <i>Note: for AC 24 V, the bus is interrupted to the left, the supply module can only supply the modules to the right with 24V~V.</i></li></ul>
TXS1.EF10 bus connection module)	<ul style="list-style-type: none"><li>• To supply the field devices, an AC / DC 12 ... 24 V supply voltage is connected via a T 10A fuse to the island bus ("Field supply V<math>\approx</math>", maximum admissible current 6 A). <i>Note: for V<math>\approx</math>, the bus is interrupted to the left, the bus connection module can only supply the modules to the right with V<math>\approx</math>.</i></li></ul>
Interfaces	<ul style="list-style-type: none"><li>• Plug-in screw terminals for supply voltage (24V~, V<math>\approx</math>, <math>\perp</math>) and island bus (CS, CD)</li></ul>
Island bus	<ul style="list-style-type: none"><li>• The I/O modules are mounted to the <b>right</b> of the supply module / bus connection module on the standard mounting rail. The electrical connection is established via the four island bus contacts on the side of the modules. The bus is created automatically when the TX-I/O™ devices are connected one next to the other on the rail.</li><li>• For expansion purposes, the CS and CD signals of the island bus are also routed via terminals.</li></ul>
System ground	<ul style="list-style-type: none"><li>• The I/O modules and all connected field devices are connected to the same system ground (<math>\perp</math>).</li><li>• The system ground of the I/O island (<math>\perp</math>) and of the automation station (G0) are electrically connected (in the P-Bus interface module)</li></ul>
Fuse	<ul style="list-style-type: none"><li>• In the event of overload or short circuit, the fuse (T 10A) cuts off the AC 24 V / V<math>\approx</math> field supply voltage (but not the supply module's supply voltage)</li><li>• The fuse can be replaced without removing the device.</li></ul>
Protection against incorrect wiring	<ul style="list-style-type: none"><li>• All terminals are protected against shortcut and incorrect wiring with AC/DC 24 V</li><li>• This is the case even for incorrect AC phase sequence</li><li>• <b>Bus connector on side: no protection</b></li><li>• <b>Voltage &gt; AC/DC 24 V: no protection</b></li></ul>



### LED indication

Fuse LED  
for field supply  
(TXS1.12F10 only)



Indicator for AC 24 V supply to supply module and field supply:

- ON AC 24 V (supply voltage) input present, and Fuse OK
- OFF No AC 24 V (supply voltage) input, or Fuse blown

Fuse LED  
for field supply  
(TXS1.EF10 only)

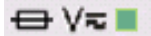

Indicator for field supply voltage  $V_{\sim}$ :

- ON  $V_{\sim}$  (field supply voltage) input present (> 22 V), and Fuse OK  
Voltage <22V are not indicated!
- OFF No  $V_{\sim}$  (field supply voltage) input, or Fuse blown

Module supply LED



(CS conductor)

Indicates DC 24 V module supply / field supply:

- ON Module supply OK. *When other supplies are in the I/O island (CS >21.5 V) and AC 24 V is OK, the LED is also ON.*
- OFF Module supply voltage not OK  
Reasons: no AC 24 V (supply voltage) input, or AC/DC converter faulty, or short circuit at DC 24 V connections (CS)

### Circuit principles (TXS1.12F10 power supply module)

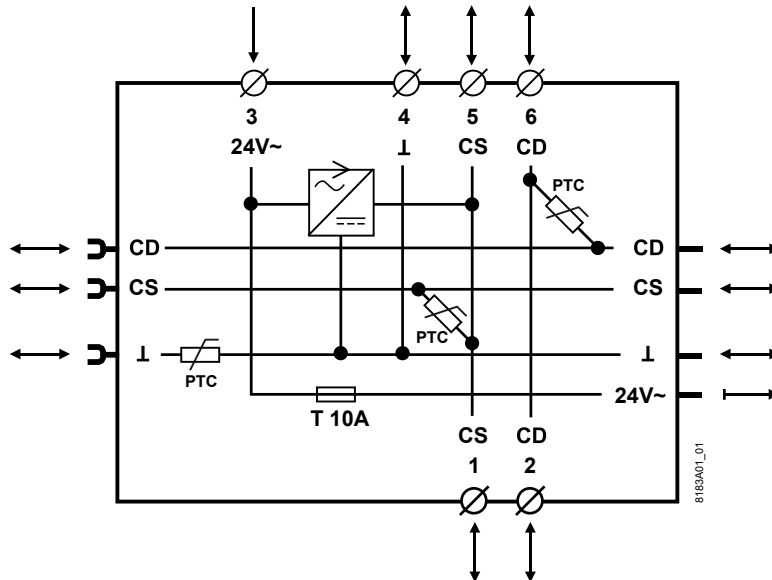

### Note!

For AC 24 V, the bus is interrupted to the left, the supply module can only supply the modules to the right with 24V~V.

**Circuit principles  
(TXS1.EF10 bus  
connection module)**

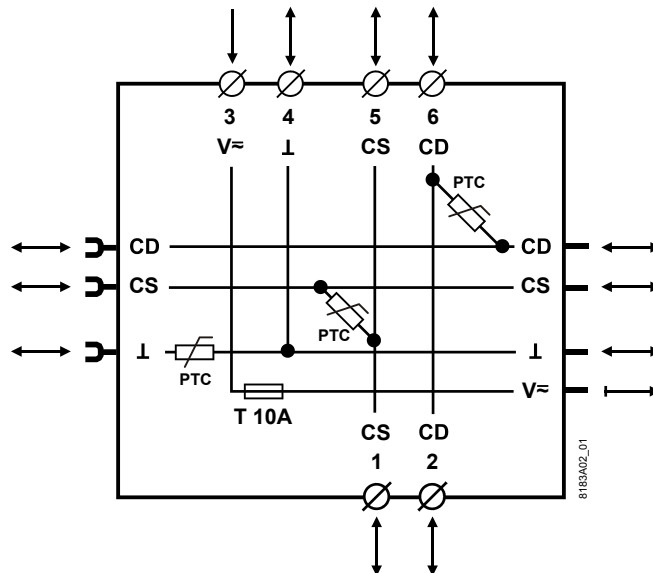

**Note!**

For V~, the bus is interrupted to the left, the bus connection module can only supply the modules to the right with V~.

**Disposal**



The device is considered an electronics device for disposal in terms of European Directive 2012/19/EU and may not be disposed of as domestic garbage.

- Dispose of the device through channels provided for this purpose.
- Comply with all local and currently applicable laws and regulations.

**Engineering, mounting, installation and commissioning**

Please refer to the following documents

Document	Number
[1] TX-I/O™ module data sheets	CM1N817...
[2] TX-I/O™ functions and operation	CM110561
[3] TX-I/O™ Engineering and installation manual	CM110562
[4] Replacement of legacy signal types	CM110563
[5] TX-I/O™ Engineering documentation V2.35	CM110641 ff
[6] TX-I/O™ Engineering documentation V4	CM111001 ff

**Engineering**

The following information is required when designing the power supply for an I/O island (see [3]):

- Number and type of modules to be supplied  
(Basic consumption of I/O module)
- Type and number of data points  
(Consumption per configured data point)
- Type and number of field devices to be supplied from the field device supply

**Caution!** 

- The **cable insulation** must always comply with the present rated voltage.
- When the supply voltage of the Devices is transited to external devices, the cable **cross section** must always correspond to the rated current of the safety circuit breaking device.  
Observe local regulations in any case.

---

**Mounting**

---

**Mounting**

The module is mounted on a standard 35 x 7.5 mm mounting rail (top-hat rail type TH35-7.5 to EN60715)

**Mounting sequence**

An I/O row always starts on the "left" side with a device for power supply (power supply module, bus connection module, BIM, or automation station, see [3])

**Replacement**

A power supply module or bus connection module can be removed from the row of modules, **but to do this, it is essential to remove the plug-in I/O unit from the adjacent module to the right.** There is no need to remove the terminal base of this module.

**Permitted orientation**

The TX-I/O™ devices can be installed in any orientation:

It is important to provide adequate ventilation so that the admissible ambient temperature (max. 50°C) is not exceeded.

---

**Technical data**

---

Operating voltage (24V~, ⊥)	Extra low voltage SELV or PELV in accordance with HD348	AC 24 V, -10 ... +20% or AC 24 V class 2 (US) 50 ... 60 Hz Symmetrical
Power consumption TXS1.12F10	– Without module and field device load	4 VA / 0.17 A
Pass-through TXS1.12F10	– With maximum admissible load DC 24 V / 1.2 A	57 VA / 2.4 A
Pass-through TXS1.EF10	– AC 24 V / 6 A (for details refer to [3])	144 VA / 6 A
Fusing	– AC / DC 24 V / 6 A (for details refer to [3])	144 VA / 6 A
	External supply line protection (EU)	Fuse slow max. 10 A or Circuit breaker max. 13 A Characteristic B, C, D according to EN 60898 or Power source with current limitation of max. 10 A
Protection	Bus connector on side	No protection against shortcut and incorrect wiring

---

DC output (CS, ⊥)	Nominal voltage	DC 24V
	Max. current	1.2 A
	Can be connected in parallel (regulated output voltage)	For details refer to [3]
	Short-circuit-proof, overload protected	
	Excess temperature cutout Indication	Self-resetting LED "24V="
AC output (24V~, ⊥) (TXS1.12F10 only)	Nominal voltage	AC 24 V
	Max. current	6.0 A
	Fuse	T 10A (replaceable)
	Indication	LED "24V~"
AC /DC output ( $V_{\approx}$ , ⊥) (TXS1.EF10 only)	Nominal voltage	AC / DC 12 ... 24 V
	Max. current	6.0 A
	Fuse	T 10A (replaceable)
	Indication	LED "24V~"
Island bus communication Plug-in connection terminals	(CD, CS)	Short-circuit proof
	Mechanical design	Plug-in screw terminals
	Solid or stranded copper conductors with connector sleeves	1 x 0,6 mm $\varnothing$ to 2.5 mm <sup>2</sup> or 2 x 0,6 mm $\varnothing$ to 1.0 mm <sup>2</sup>
	Stranded copper conductors without connector sleeves	1 x 0,6 mm $\varnothing$ to 2.5 mm <sup>2</sup> or 2 x 0,6 mm $\varnothing$ to 1.5 mm <sup>2</sup>
	Screwdriver	Slot-headed screws Screwdriver No. 1 <i>with shaft diameter <math>\leq</math> 4.5 mm</i>
	Max. tightening torque	0.6 Nm
Classification to EN 60730	Mode of operation of automatic electrical controls	Type 1
	Contamination level	2
	Mechanical design	Protection class III
Housing protection standard	Protection standard to EN 65029	
	Front-plate components in DIN cut-out	IP 30
	Terminal section	IP20
Ambient conditions	Operation	To IEC 60721-3-3
	Climatic conditions	Class 3K5
	Temperature	-5 ... 50 °C
	Humidity	5 ... 95 % rh
	Mechanical conditions	Class 3M2
	Transport	To IEC 60721-3-2
	Climatic conditions	Class 2K3
	Temperature	-25 ... 70 °C
	Humidity	5 ... 95 % rh
	Mechanical conditions	Class 2M2



Standards, directives and approbations	Product standard	EN 60730-1	Automatic electrical controls for household and similar use
	Electromagnetic compatibility (Applications)		For use in residential, commercial, light-industrial and industrial environments
	EU conformity (CE)		CM1T10870xx *)
	UL certification (US)		UL 916, <a href="http://ul.com/database">http://ul.com/database</a>
	CSA certification		Class 4812 <a href="http://directories.csa-international.org/">http://directories.csa-international.org/</a>
Environmental compatibility	RCM-conformity (EMC)		CM1T10870en_C1 *)
	EAC conformity		Eurasia conformity
Color	Product environmental declaration (contains data on RoHS compliance, materials composition, packaging, environmental benefit, disposal)		CM2E8183 *)
	Body		RAL 7035 (light gray)
Dimensions	Housing to DIN 43 880, see "Dimensions"		
Weight	With / without packaging	TXS1.12F10	309 g / 341 g
		TXS1.EF10	82 g / 102 g

\*) The documents can be downloaded from <http://siemens.com/bt/download>.

### Connection example

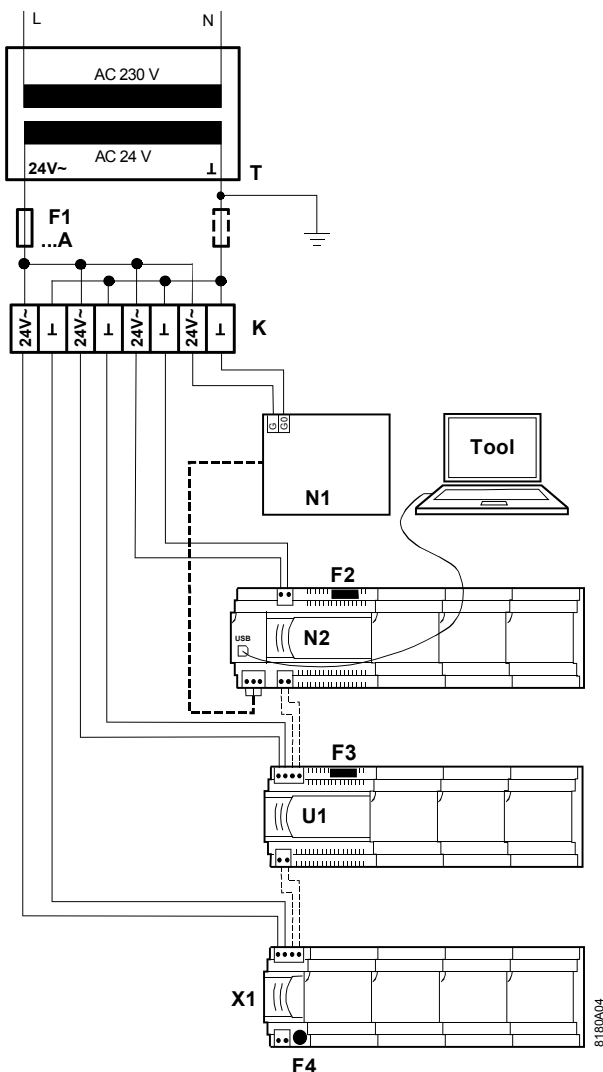

#### Key

———— AC 24 V

- - - - P bus

==== Island bus

T Safety isolating transformer AC 230 V/AC 24 V to EN 61 558

K Terminal strip for ac 24 V distribution via star configuration

N1 Automation station

N2 Bus interface module with integral power supply

U1 TXS1.12F10 power supply module

X1 TXS1.EF10 bus connection module

F1 Extra-low voltage fuse for max. power consumption, AC 24 V

F2 Fine-wire slow-blow 10 A fuse, factory-fitted in bus interface module

F3 Fine-wire slow-blow 10 A fuse, factory-fitted in power supply module

F4 Fine-wire slow-blow 10 A fuse, factory-fitted in bus connection module

Tool TX-I/O tool for configuration, simulation and diagnostics

## Dimensions

Dimensions  
in mm

### TXS1.12F10

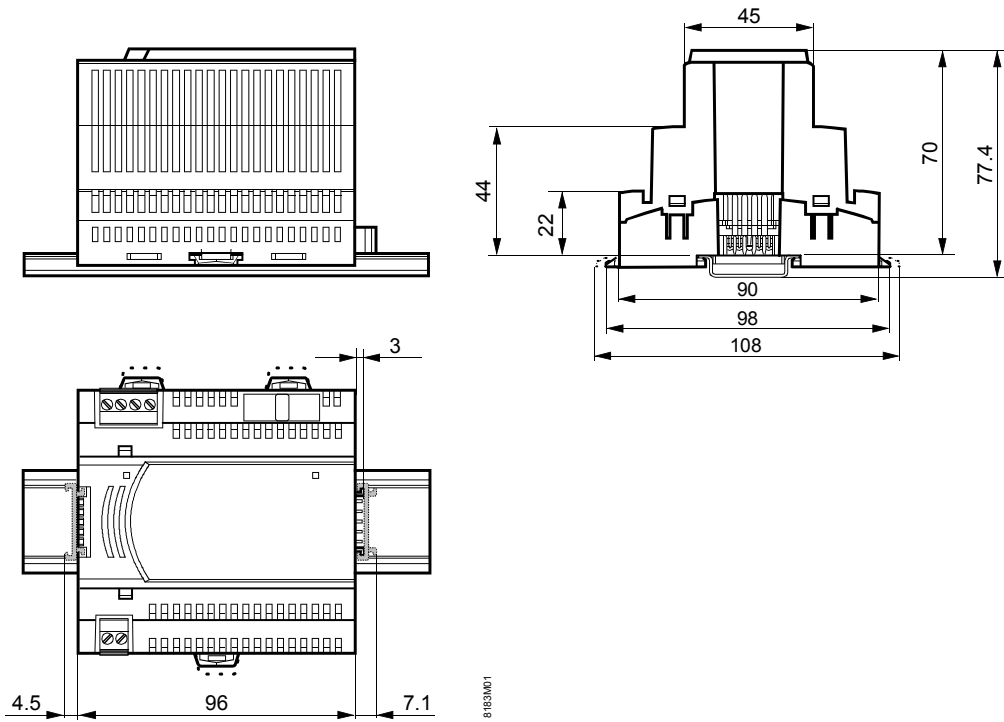

### TXS1.EF10

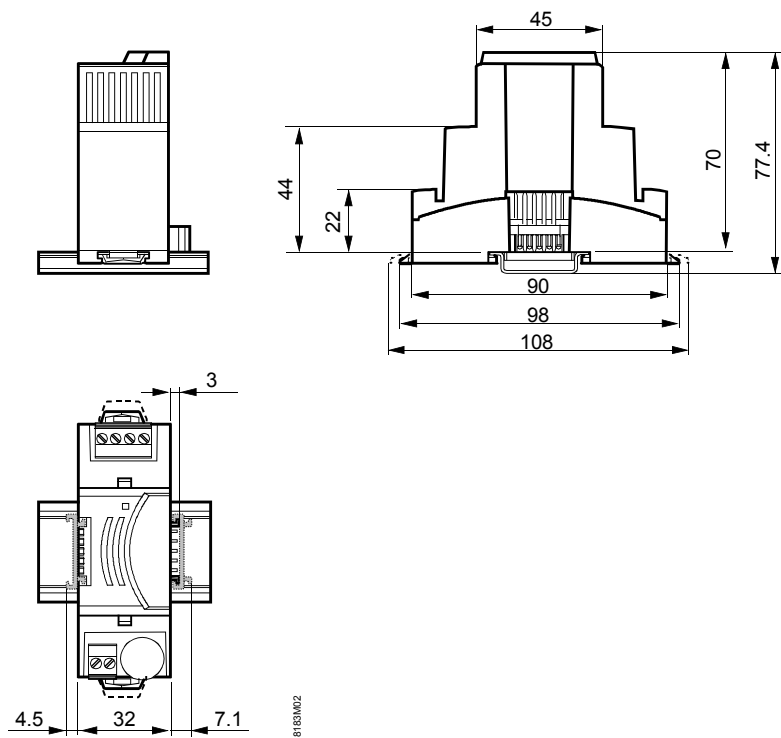

Published by:  
Siemens Switzerland Ltd.  
Building Technologies Division  
International Headquarters  
Gubelstrasse 22  
6301 Zug  
Switzerland  
Tel. +41 41-724 24 24  
[www.siemens.com/buildingtechnologies](http://www.siemens.com/buildingtechnologies)

© Siemens Switzerland Ltd 2007  
Delivery and technical specifications subject to change