

SIEMENS



FT2010

Floor repeater terminal

Operation Manual

MP7/IP7

Imprint

Technical specifications and availability subject to change without notice.

Transmittal, reproduction, dissemination and/or editing of this document as well as utilization of its contents and communication thereof to others without express authorization are prohibited. Offenders will be held liable for payment of damages. All rights created by patent grant or registration of a utility model or design patent are reserved.

Issued by:
Siemens Switzerland Ltd.
Building Technologies Division
International Headquarters
Theilerstrasse 1a
CH-6300 Zug
Tel. +41 58 724-2424
www.siemens.com/buildingtechnologies

Edition: 2018-08-29
Document ID: 009310_I_en_--

© Siemens Switzerland Ltd, 2006

Table of contents

1	About this document	5
1.1	Displays used in document	7
1.2	Applicable documents	7
1.3	Download center	8
1.4	Technical terms and abbreviations	8
1.5	Revision history	8
2	Safety	9
2.1	Safety instructions	9
2.2	Safety regulations for the method of operation	10
2.3	Standards and directives complied with.....	12
2.3.1	Current Firmware Version Status	12
2.4	Release Notes	13
3	Features	14
3.1	Maximum number of events that can be displayed.....	14
4	PMI	15
4.1	Buttons on the PMI.....	16
4.2	Display	16
4.3	Key switch	17
4.4	LEDs.....	17
5	Service menu	18
6	Operation	19
6.1	ALARM Procedure	19
6.2	Switch off alarm delay	21
6.3	Resetting an alarm	21
6.4	Procedure in case of Fault	22
6.5	Switching an object on / off	23
6.6	Testing indicators	24
6.7	Indicating and scrolling in lists.....	24
6.7.1	Show ALARM list	24
6.7.2	Indicating fault list	25
6.7.3	Show pre-ALARMS.....	26
6.7.4	Show isolation list	27
6.7.5	Display List Technical Message	28
6.8	Open service menu / Select menu item	28
7	Alarm verification concept (AVC)	29
7.1	Attendance check.....	30
7.2	Investigation time	30
7.3	Example of a verification process	30
7.4	Fire alarming	32

8	Faults / Troubleshooting	34
9	Maintenance.....	35
	Glossary.....	36
	Index	38

1 About this document

Goal and purpose

This document describes the operation of the floor repeater terminal FT2010 in a fire detection system. The reader shall become familiar with the possible indications and operating functions on the terminal, as well as with the functionality of the terminal in the overall system. This understanding makes an adequate behaviour possible in the event of fire or fault.

Scope

This document applies to the floor repeater terminal type FT2010.

Target groups

The information in this document is intended for the following target groups:

Target group	Activity	Qualification
System owner	<ul style="list-style-type: none"> According to EN 50110-1, 'nominated person with the overall responsibility to ensure the safe operation of the electrical installation by setting rules and organisation or framework.' 	<ul style="list-style-type: none"> 'This person can be the owner, employer, proprietor or a delegated person.' 'Some of these duties can be delegated to others as required. For large or complex electrical installations or networks, the duties can be delegated for parts of the installations or the network.'
Commissioning personnel	<ul style="list-style-type: none"> Configures the product at the place of installation according to customer-specific requirements. Checks the product operability and releases the product for use by the operator. Searches for and corrects malfunctions. 	<ul style="list-style-type: none"> Has obtained suitable specialist training for the function and for the products. Has attended the training courses for commissioning personnel.
Operating personnel	<ul style="list-style-type: none"> Carries out procedures to correctly operate the product. 	<ul style="list-style-type: none"> No particular basic training is needed. Has been instructed by the commissioning personnel.
Maintenance personnel	<ul style="list-style-type: none"> Carries out all maintenance work. Checks that the products are in perfect working order. Searches for and corrects malfunctions. 	<ul style="list-style-type: none"> Has obtained suitable specialist training for the function and for the products.

Source language and reference document

- The source/original language of this document is German (de).
- The reference version of this document is the international version in English. The international version is not localized.

Document identification

The document ID is structured as follows:

ID code	Examples
ID_ModificationIndex_Language_COUNTRY -- = multilingual or international	A6V10215123_a_de_DE A6V10215123_a_en_-- A6V10315123_a_--_--

Date format

The date format in the document corresponds to the recommendation of international standard ISO 8601 (format YYYY-MM-DD).

Conventions for text marking

Markups

Special markups are shown in this document as follows:

>	Requirement for a behavior instruction
1. 2.	Behavior instruction with at least two operation sequences
–	Version, option, or detailed information for a behavior instruction
⇒	Intermediate result of a behavior instruction
⇨	End result of a behavior instruction
•	Numbered lists and behavior instructions with an operation sequence
[→ X]	Reference to a page number
'Text'	Quotation, reproduced identically
<Key>	Identification of keys
>	Relation sign and for identification between steps in a sequence, e.g., 'Menu bar' > 'Help' > 'Help topics'
↑ Text	Identification of a glossary entry

Supplementary information and tips



The 'i' symbol identifies supplementary information and tips for an easier way of working.

1.1 Displays used in document

The form of display in the document sometimes uses tables.

Deviations between the original and the table representation are shown below as examples:

ABCDE FGHI	07:55:31
ABCD: 3	
!ABCD: 421 ABC: 32	XXX YYY ZZZ
ABCDEFGHI AAA/BBB	3
ABCD: 026 ABC: 75	XXX YYY ZZZ
ABCDE CCC	2

Figure 1: Original display figure

ABCDE FGHI	07:55:31
ABCD: 3	
! ABCD: 421 ABC: 32	XXX YYY ZZZ
ABCDEFGHI AAA/BBB	3
+ ABCD: 026 ABC: 75	XXX YYY ZZZ
ABCDE CCC	2

Table 1: Display representation in tables

The table representation has the following key deviations from the original:

- Font and representation (proportional font, not inverted)
- No frame around selection

1.2 Applicable documents

Sinteso document ID	Title
008838	FC20xx / FT2040 operation

Cerberus PRO document ID	Title
A6V10211076	FC7xx / FT724 operation

1.3 Download center

You can download various types of documents, such as data sheets, installation instructions, and license texts via the following Internet address:

<https://siemens.com/bt/download>

- Enter the document ID in the search field.



You will also find information about search variants and links to mobile applications (apps) for various systems on the home page.

1.4 Technical terms and abbreviations

You will find details of technical terms and abbreviations in the 'Glossary' chapter.

1.5 Revision history

The reference document's version applies to all languages into which the reference document is translated.



The first edition of a language version or a country variant may, for example, be version 'd' instead of 'a' if the reference document is already this version.

Version	Edition date	Brief description
l	2018-08-29	Edition for MP7/IP7
k	2015-12-15	Edition for MP6/IP6: Referenced documents updated
j	2014-01-28	Chapter 'LEDs' revised
i	2013-11-14	Edition for MP5/IP5
h	2013-05-20	Change to date format according to ISO 8601 CPR replaces CPD: The Construction Products Regulation (CPR 305/2011) replaces the previous Construction Products Directive (CPD 89/106).
g	03.2012	Market package MP-EN 4.0 / Introduction Package IP4
f	05.2010	MP3.0/MP3.0 XS Revision history redefined and standardized.
e	02.2009	MP2.1/MP1XS edition, glossary deleted
d	06.2008	Safety chapter revised, addition to "Resetting an alarm" removed
c	04.2008	Addition to "Resetting an alarm", chap. IC deleted
b	07.2007	Restriction "Visibility not system-wide" deleted
a	09.2006	First edition

2 Safety

2.1 Safety instructions

The safety notices must be observed in order to protect people and property.

The safety notices in this document contain the following elements:







- Symbol for danger
- Signal word
- Nature and origin of the danger
- Consequences if the danger occurs
- Measures or prohibitions for danger avoidance

Symbol for danger

	This is the symbol for danger. It warns of risks of injury . Follow all measures identified by this symbol to avoid injury or death.
---	--

Additional danger symbols

These symbols indicate general dangers, the type of danger or possible consequences, measures and prohibitions, examples of which are shown in the following table:

	General danger		Explosive atmosphere
	Voltage/electric shock		Laser light
	Battery		Heat

Signal word

The signal word classifies the danger as defined in the following table:

Signal word	Danger level
DANGER	'DANGER' identifies a dangerous situation, which will result directly in death or serious injury if you do not avoid this situation.
WARNING	'WARNING' identifies a dangerous situation, which may result in death or serious injury if you do not avoid this situation.
CAUTION	'CAUTION' identifies a dangerous situation, which could result in slight to moderately serious injury if you do not avoid this situation.
<i>NOTICE</i>	'NOTICE' identifies a possibly harmful situation or possible damage to property that may result from non-observance. 'NOTICE' does not relate to possible bodily injury.

How risk of injury is presented

Information about the risk of injury is shown as follows:

	⚠ WARNING
	Nature and origin of the danger Consequences if the danger occurs <ul style="list-style-type: none"> • Measures / prohibitions for danger avoidance

How possible damage to property is presented

Information about possible damage to property is shown as follows:

	NOTICE
	Nature and origin of the danger Consequences if the danger occurs <ul style="list-style-type: none"> • Measures / prohibitions for danger avoidance

2.2 Safety regulations for the method of operation



National standards, regulations and legislation

Siemens products are developed and produced in compliance with the relevant European and international safety standards. Should additional national or local safety standards or legislation concerning the planning, mounting, installation, operation or disposal of the product apply at the place of operation, then these must also be taken into account together with the safety regulations in the product documentation.

Electrical installations

	⚠ WARNING
	Electrical voltage Electric shock <ul style="list-style-type: none"> • Work on electrical installations may only be carried out by qualified electricians or by instructed persons working under the guidance and supervision of a qualified electrician, in accordance with the electrotechnical regulations.

- Wherever possible disconnect products from the power supply when carrying out commissioning, maintenance or repair work on them.
- Lock volt-free areas to prevent them being switched back on again by mistake.
- Label the connection terminals with external voltage using a 'DANGER External voltage' sign.
- Route mains connections to products separately and fuse them with their own, clearly marked fuse.
- Fit an easily accessible disconnecting device in accordance with IEC 60950-1 outside the installation.
- Produce earthing as stated in local safety regulations.

	⚠ CAUTION
	<p>Noncompliance with the following safety regulations</p> <p>Risk of injury to persons and damage to property</p> <ul style="list-style-type: none"> • Compliance with the following regulations is required.
	<ul style="list-style-type: none"> • Specialist electrical engineering knowledge is required for installation. • Only an expert is permitted to carry out installation work. <p>Incorrect installation can take safety devices out of operation unbeknown to a layperson.</p>

Mounting, installation, commissioning and maintenance

- If you require tools such as a ladder, these must be safe and must be intended for the work in hand.
- When starting the fire control panel ensure that unstable conditions cannot arise.
- Ensure that all points listed in the 'Testing the product operability' section below are observed.
- You may only set controls to normal function when the product operability has been completely tested and the system has been handed over to the customer.

Testing the product operability

- Prevent the remote transmission from triggering erroneously.
- If testing building installations or activating devices from third-party companies, you must collaborate with the people appointed.
- The activation of fire control installations for test purposes must not cause injury to anyone or damage to the building installations. The following instructions must be observed:
 - Use the correct potential for activation; this is generally the potential of the building installation.
 - Only check controls up to the interface (relay with blocking option).
 - Make sure that only the controls to be tested are activated.
- Inform people before testing the alarm devices and allow for possible panic responses.
- Inform people about any noise or mist which may be produced.
- Before testing the remote transmission, inform the corresponding alarm and fault signal receiving stations.

Modifications to the system design and the products

Modifications to the system and to individual products may lead to faults, malfunctioning and safety risks. Written confirmation must be obtained from Siemens and the corresponding safety bodies for modifications or additions.

Modules and spare parts

- Components and spare parts must comply with the technical specifications defined by Siemens. Only use products specified or recommended by Siemens.
- Only use fuses with the specified fuse characteristics.
- Wrong battery types and improper battery changing lead to a risk of explosion. Only use the same battery type or an equivalent battery type recommended by Siemens.
- Batteries must be disposed of in an environmentally friendly manner. Observe national guidelines and regulations.

Disregard of the safety regulations

Before they are delivered, Siemens products are tested to ensure they function correctly when used properly. Siemens disclaims all liability for damage or injuries caused by the incorrect application of the instructions or the disregard of danger warnings contained in the documentation. This applies in particular to the following damage:

- Personal injuries or damage to property caused by improper use and incorrect application
- Personal injuries or damage to property caused by disregarding safety instructions in the documentation or on the product
- Personal injury or damage to property caused by poor maintenance or lack of maintenance

2.3 Standards and directives complied with

A list of the standards and directives complied with is available from your Siemens contact.

2.3.1 Current Firmware Version Status

!	<p>NOTICE</p> <p>Not the current firmware version status of a newly installed fire detection installation</p> <p>Possible limitations for the configuration or use of devices.</p> <ul style="list-style-type: none"> • Compare the firmware version of a newly installed fire detection installation with the currently approved firmware version status. • Use the currently approved firmware version status. • Update the firmware if required, in accordance with the chapter 'FW update for main CPU and additional CPUs' in document 009052; see chapter 'Applicable documents'.
----------	--

2.4 Release Notes

Limitations to the configuration or use of devices in a fire detection installation with a particular firmware version are possible.

	<p>⚠ WARNING</p>
	<p>Limited or non-existent fire detection Personal injury and damage to property in the event of a fire.</p> <ul style="list-style-type: none"> • Read the 'Release Notes' before you plan and/or configure a fire detection installation. • Read the 'Release Notes' before you carry out a firmware update to a fire detection installation.

	<p>NOTICE</p>
	<p>Incorrect planning and/or configuration Important standards and specifications are not satisfied. Fire detection installation is not accepted for commissioning. Additional expense resulting from necessary new planning and/or configuration.</p> <ul style="list-style-type: none"> • Read the 'Release Notes' before you plan and/or configure a fire detection installation. • Read the 'Release Notes' before you carry out a firmware update to a fire detection installation.

3 Features

The ↑ floor repeater terminal is an indication and operating unit in a fire detection installation with the following functions:

Indication of events

- 'ALARM'
 - 'Pre-ALARM'
- 'Fault'
- 'Isolation'
- ↑ 'Technical message'

Operation

- 'Alarm delay off'
- 'Silence buzzer'
- 'Acknowledge'
- 'Events' 'Reset'
- ↑ Switch off (pre-configured) ↑ 'Section' or 'Zone'
- Show lists
 - 'Pre-ALARM'
 - 'Isolation'
 - 'Fault'
- 'Initiate display test'

The display on the floor repeater terminal is synchronized with 'Stations' of the configured ↑ visibility and shows the same event texts.



The possible number of displayed events is limited. You will find details in the corresponding section.

3.1 Maximum number of events that can be displayed

The maximum number of events that can be displayed is limited and depends on the length of the event texts. Assuming that the event texts are long, the following maximum numbers of events apply to the corresponding displays:

- Extended view: 18
- Standard view: 37
- Details view: 20



Events are displayed in order of priority. If the maximum number of events that can be displayed is reached, events with higher priority replace those with lower priority in the display.

Events which are no longer displayed due to the limitation can be listed completely on the control panel.

See also

- 📄 [Indicating and scrolling in lists \[→ 24\]](#)

4 PMI

The figure below shows the PMI of the ↑ floor repeater terminal.

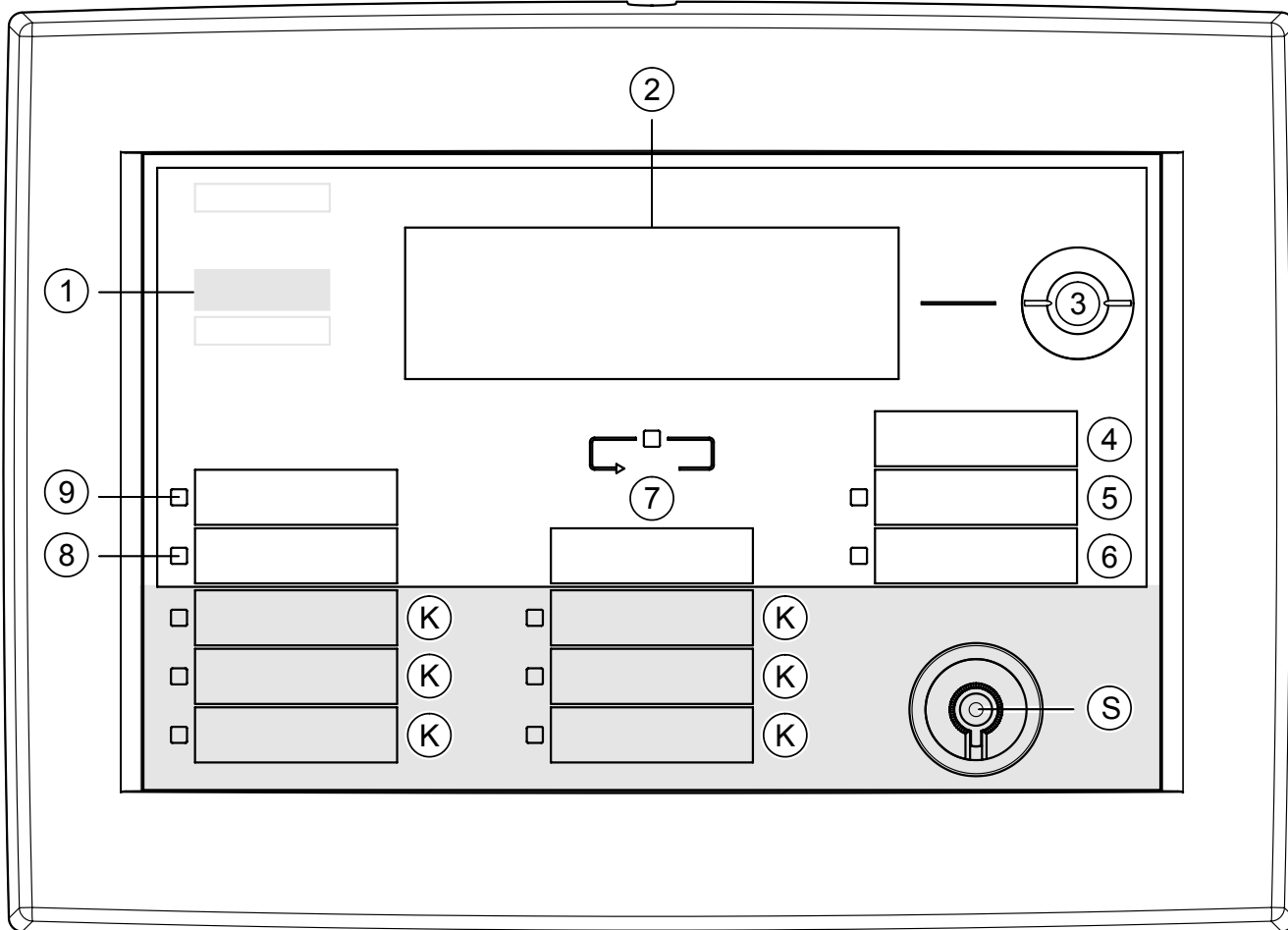

Figure 2: PMI of the floor repeater terminal

- | | | | |
|---|-------------------------|---|--------------------------------------|
| 1 | 'ALARM' LEDs | 7 | 'More alarms' button |
| 2 | Display | 8 | LED 'System On' |
| 3 | Navigation buttons | 9 | LED 'Remote alarm Active' |
| 4 | 'Silence buzzer' button | K | LEDs and function keys, configurable |
| 5 | 'Acknowledge' button | S | Key switch |
| 6 | 'Reset' button | | |

4.1 Buttons on the PMI

Navigation buttons

The navigation buttons work in the same way as the arrow keys on a PC keyboard. With the buttons <▲> and <▼> it is possible to scroll to the next entry in a list.

<Silence buzzer>

Switches the buzzer off.

<Acknowledge>

- Acknowledges all 'Events' that can be acknowledged
- Confirms presence (↑ 'AVC', 'IC')
- Switches the buzzer and 'Internal sounders' off.

<Reset>

Resets all 'Events' that can be reset

<More alarms>

By pressing the <More alarms> button, the display changes to the next alarm event. In case of alarm, this button has the same function as the navigation button <▼>.

Configurable buttons

These configurable buttons may, for example, be assigned with the following functions:

- 'Alarm delay off'
 - Switches off the alarm delay for all 'Events'
 - In the event of an alarm, the remote transmission, or global alarming, respectively, is activated immediately
- Fault list indication
- Isolation list indication
- 'Pre-ALARMS' display
- ↑ Switch off ↑ 'Section' or 'Zone'
- 'LED test'

4.2 Display

The display has two areas:

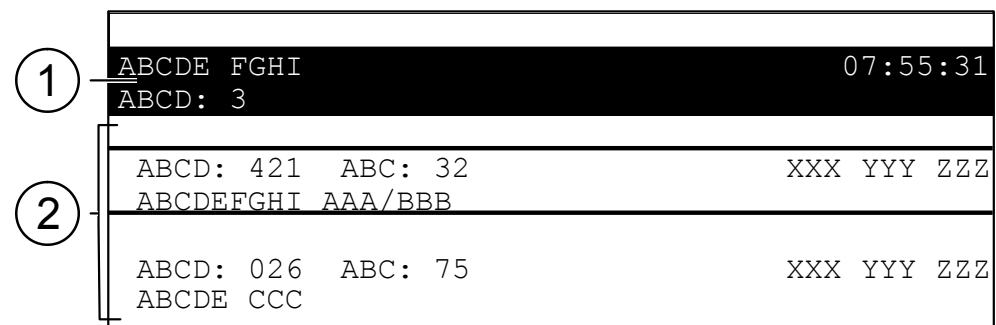

Figure 3: Display representation with two indicated messages

1 Header

2 Representation area

4.3 Key switch

You can use the 'Key switch' to release the operation.

The 'Key switch' has two positions:

- ON (horizontal position)
- OFF (vertical position)

4.4 LEDs

The LEDs on the ↑ Person Machine Interface signal 'Events' and conditions. In addition, the LEDs support the operator's orientation. The LEDs can light up in red, yellow, or green. The LEDs can be configured according to customer-specific requirements.

The LED colors can, for example, signal the following information:

Red	<ul style="list-style-type: none">• ALARM• Activations, e.g., ↑ remote transmission, ↑ alarm devices, control function
Yellow	<ul style="list-style-type: none">• Fault• Isolation• Deactivation, e.g. remote transmission, alarm devices, control function
Green	<ul style="list-style-type: none">• System is in operation

Additional information on the conditions of the LEDs (steady on, steady off or flashing) can be found in the relevant chapter.

5 Service menu

Various settings can be performed using a service menu. You can open the service menu using a keyboard shortcut (see corresponding chapter).

After calling up the menu and entering a password, the following menu items are available:

- 'Device information'
 - Shows detailed information on the device.
- 'Buzzer on/off'
 - Settings of the buzzer.
- 'LED test'
 - Function test of the LED.
- 'Key test'
 - Function test for the buttons of the PMI.
- 'LCD test'
 - Function test of the display.
- 'LCD contrast'
 - Setting of the display contrast in percent.
- 'exit'
 - Closes the service menu.

See also

- 📄 [Open service menu / Select menu item \[→ 28\]](#)

6 Operation

6.1 ALARM Procedure

If your fire detection system has no delayed alarm transmission function ('AVC'), the variant –'Fire Brigade in' 'mm:ss' in Step 2 (see Procedure in the event of alarm) does not apply.

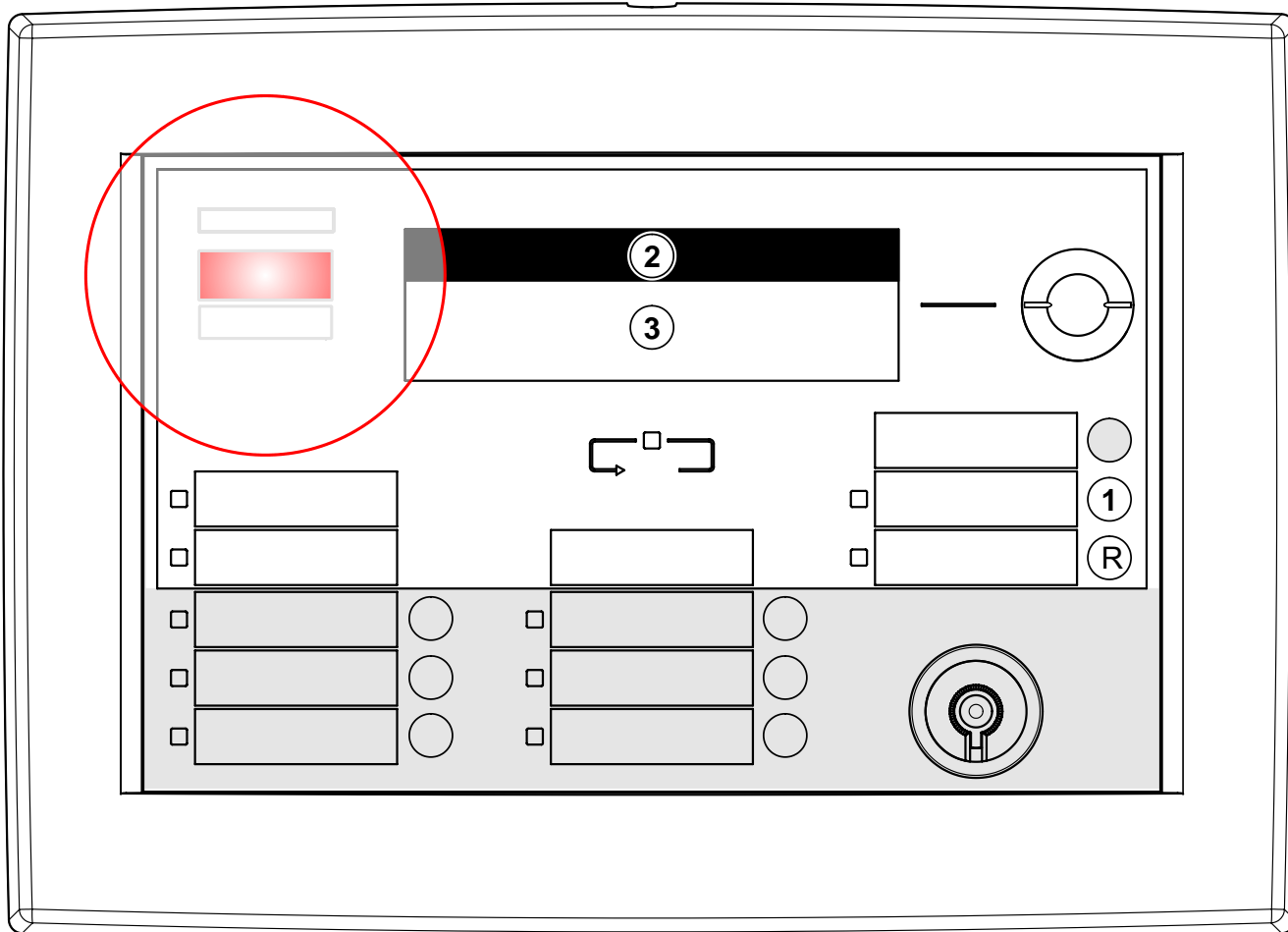

Figure 4: ALARM operation sequence

- | | | | |
|---|-------------------------|---|--|
| 1 | <Acknowledge> | 3 | Indication of the fire location on the display |
| 2 | Top line on the display | R | <Reset> |

The <Alarm delay off> button is not indicated as the command can be assigned to each of the configurable buttons.

Procedure in the event of alarm

Step	Action / Condition	Consequence / Status
1	Press <Acknowledge> on the ↑ Person Machine Interface	With 'AVC', countdown t2 for the examination of the 'ALARM' source starts
2	Read top line on display	
	– 'Fire Brigade requested'	'ALARM' is transmitted to the fire brigade
	– 'Fire Brigade in' 'mm:ss'	'ALARM' is transmitted to fire brigade in 'mm:ss' Remaining time is shown as Countdown
	– 'Call Fire Brigade !' If: <ul style="list-style-type: none"> • Remote transmission switched off • Remote transmission blocked or defective • No remote transmission available 	Fire brigade must be called by phone! No automatic transmission to fire brigade
3	Read off fire location on display	
4	Go to the fire location	
5	Decide: MAJOR INCIDENT or ↑ minor incident	

Condition	MAJOR INCIDENT	↑ Minor incident
Fire brigade has been called	Save people Guide the fire brigade to the fire location Fight the fire	Try to prevent fire brigade deployment Press <Reset>
'Fire Brigade in' 'mm:ss' Countdown is running	Trigger 'Manual call point' immediately or Press <Alarm delay off>	Press <Reset>
'Call Fire Brigade !' No automatic transmission to the fire brigade	Call the fire brigade on the phone!	Press <Reset>



To reset, the key switch must be used.

It may be necessary to air the room before resetting is possible.

Elements that cannot be reset can be switched off temporarily on the control panel.

6.2 Switch off alarm delay

An alarm delay in case of alarm is only possible if the fire detection installation is provided with ↑ 'AVC'. Alarm delay is a countdown until global alarming is initiated. In case of alarm, the alarm delay can be switched off. Global alarming is triggered immediately!

Switching off the alarm delay

- Press <Alarm delay off>.
- ⇒ Global alarming is activated immediately.

6.3 Resetting an alarm



The alarm message must be acknowledged before 'ALARM' 'Reset'.

In order to 'ALARM'-'Reset', the 'Key switch' must be moved into its horizontal position.

If the cause of an 'ALARM' is not remedied, a new alarm event will be triggered after 'ALARM' Reset'.

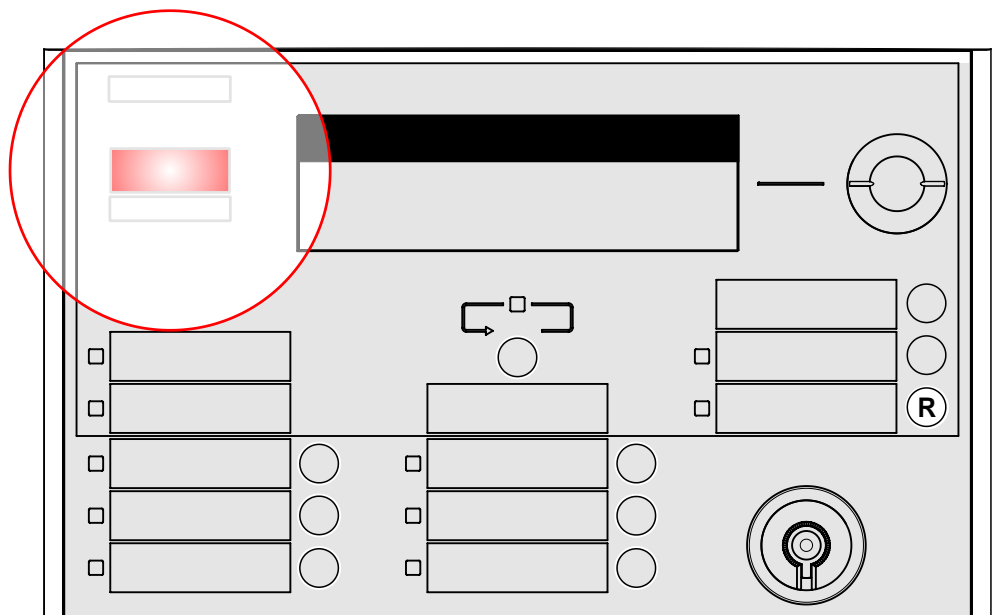

↑ Person Machine Interface with R button ('Reset')

'ALARM' 'Reset'

1. Turn the 'Key switch' into a horizontal position.
 - ⇒ Operation is released.
2. Acknowledge the alarm message.
3. Press <R>.
 - ⇒ 'ALARM' is reset.
 - ⇒ The ↑ floor repeater terminal is in quiescent condition if there are no other messages.

6.4 Procedure in case of Fault

Step	Action
1	Press <Buzzer on/off> on the ↑ Person Machine Interface
2	Read message/fault location on the display
3	Press <Acknowledge> on the Person Machine Interface
5	Go to the fault location
6	Eliminate the cause of the fault



A list of possible 'Faults' and how they are eliminated can be found in the chapter 'Faults / Troubleshooting'.

If you cannot eliminate a 'Fault', please contact your service provider.

'Fault' and 'Intervention Concept' ('IC')

On consideration of 'Intervention Concept', events of the 'Fault' category can be assigned their own sequence. This sequence may be configured differently and depends on the 'Manned operation' / 'Unmanned operation' operation mode.

An exemplary sequence after a 'Fault', on consideration of the 'Intervention Concept', is graphically represented in the following:

'Fault' has occurred

- 'Unmanned operation' operation mode
 - Remote transmission for 'Faults' is activated.
- 'Manned operation' operation mode
 - The remote transmission for 'Faults' is activated unless the 'Fault' is acknowledged within the delay t1.

Acknowledging 'Fault'

1. Press <Acknowledge> before the expiry of t1.
 - ⇒ The local ↑ alarming equipment is silenced.
2. Read the location of 'Fault' on the display.
3. Go to the location of 'Fault'.
4. Rectify 'Fault'.

See also

 [Faults / Troubleshooting \[→ 34\]](#)

6.5 Switching an object on / off

To avoid ↑ false alarms, you can switch off parts of a ↑ 'Site' in certain situations, e.g., for the purpose of maintenance work.

When a part of the 'Site' is switched off, the LED 'ISOLATION' is on.

In which situations the pre-configured object should be switched off, depends on the detectors used as well as on possible deceptive phenomena such as smoke, dust, heat or vapour.

You can use the <'Section' 'OFF'> button to ↑ switch off a pre-configured object at the touch of a button.



▲ WARNING

System parts that have been switched off make it impossible to acquire and process alarms or faults!

Fire may spread unhindered.

- Deploy staff to monitor the deactivated area.
- You must switch deactivated parts of the 'Site' back on as soon as possible.



If a deactivated 'Zone' is the only 'Zone' in a 'Section', the 'Section' is also indicated as deactivated.

↑ Switching off the 'Section'

▷ Before you may switch off the pre-configured object, you must release operation by means of the 'Key switch'.

1. Turn the 'Key switch' into a horizontal position.

⇒ Operation is released.

2. Press <'Section' 'OFF'>.

⇒ The pre-configured object is isolated.

⇒ LED 'ISOLATION' on.

Switching on the object

▷ The object is isolated and the LED 'ISOLATION' is on.

1. Turn the 'Key switch' into a horizontal position.

⇒ Operation is released.

2. Press <'Section' 'OFF'>

⇒ The pre-configured object is switched on.

⇒ LED 'ISOLATION' off.

6.6 Testing indicators

The 'LED test' is a functional HW check for the following indication elements:

- Display
- LEDs

The test takes 10 seconds and has two phases of 5 seconds each.

Testing the indicators and displays

- Press <LED test>.
- ⇒ 'LED test' phase 1 starts:
- ⇒ The complete display is white.
- ⇒ LEDs are in color mode 1.
- ⇒ 'LED test' phase 2 starts:
- ⇒ The complete display is black.
- ⇒ LEDs are in color mode 2.

6.7 Indicating and scrolling in lists

'Events' and conditions, starting from the floor repeater terminal's configured ↑ visibility, are indicated in lists.

If a list contains several 'Events', you may scroll to the next list item by means of the navigation buttons. The next 'Event' is highlighted.



When the 'ALARM' event list is open, the <More alarms> button assumes the function of the button <▼>, changing to the next alarm event upon activation.

See also

- 📖 Maximum number of events that can be displayed [→ 14]

6.7.1 Show ALARM list

If an 'ALARM' occurs, the 'ALARM' list is automatically indicated.

If the 'ALARM' list contains several 'ALARMS', it is possible to go to the next alarm event with the <More alarms> button.

The following representation shows an exemplary alarm event:

Fire Brigade requested		
001 ALARM		
Manual FIRE ALARM	Zone	1
Zone 1		

-		---

Alarm event

See also

- 📖 Maximum number of events that can be displayed [→ 14]

6.7.2 Indicating fault list

If a 'Fault' has occurred and is the only 'Event' in the configured ↑ visibility, this 'Event' is shown on the display directly.

If other 'Events' or conditions have occurred, such as 'Isolation' or an 'ALARM', the most important 'Event', or the most important condition, respectively, is indicated on the display.

Indication of the fault list

- ▷ A button is configured with the 'Show' 'Fault' function
- ▷ The button is labelled accordingly
- Press <'Show' 'Fault'>.
- ⇒ The fault list is indicated on the display.

Example for a fault list with two 'Faults':

002 Faults			
Device missing	Zone		1/1
Office Room 123			
Dev.location fault	Zone		3/1
Corridor 3rd floor			

Table 2: Example of fault list

See also

- 📄 [Maximum number of events that can be displayed \[→ 14\]](#)

6.7.3 Show pre-ALARMS

All 'Pre-ALARMS' which have occurred can be displayed in the configured ↑ visibility.

Displaying the 'Pre-ALARMS' list

- ▷ A button is configured with the 'Show' 'Pre-ALARMS' function
- ▷ The button is labelled accordingly
- Press '<Show' 'Pre-ALARMS'>.
- ⇒ All 'Pre-ALARMS' which have occurred within the configured ↑ visibility are indicated on the display.

Example for 'PRE-ALARM' list:

001 PRE-ALARM

PRE-ALARM	Zone	2/4
Office 22		
-----	-----	-----
-	-	--

List with 'PRE-ALARM' in 'Zone' 2/4

See also

- 📄 Maximum number of events that can be displayed [→ 14]

6.7.4 Show isolation list

All 'Isolations' within the configured ↑ visibility can be displayed.

Displaying the 'Isolations' list

- ▷ A button is configured with the 'Show' 'Isolations' function
- ▷ The button is labelled accordingly
- Press <'Show' 'Isolations'>.
- ⇒ All 'Isolations' within the configured ↑ visibility are indicated on the display.

Example for 'Isolations' list:

003 Isolations			
OFF	Office 22	Zone	2/4
OFF	MCP Corridor 2nd floor	Zone	2/1

Indication of list with two of three 'Isolations'

See also

- 📄 Maximum number of events that can be displayed [→ 14]

6.7.5 Display List Technical Message

The ↑ 'Technical messages' list with all technical messages in the configured ↑ visibility can be displayed as follows:

Displaying the ↑ 'Technical messages' list

- ▷ A button is configured with the 'Show' 'Technical messages' function
- ▷ The button is labelled accordingly
- Press <'Show' 'Technical messages'>.
- ⇒ All 'Technical messages' which have occurred within the configured ↑ visibility are indicated on the display.

Example for 'TECHNICAL' list:

005 Technical messages		
TECHNICAL	Zone	2/4
Ventilation flap Office 22		
TECHNICAL	Zone	2/1
Valve Corridor 3rd floor		
-----	-----	-----
--		---

Display of the list with 2 of 5 'Technical messages'

See also

- 📖 Maximum number of events that can be displayed [→ 14]

6.8 Open service menu / Select menu item

To open the service menu a keyboard shortcut as well as a password are required.

The service menu can only be opened when no 'Event' is displayed.



Opening the service menu

- ▷ No 'Event' are displayed.
- 1. Press <More Alarms>, with <Reset> button pressed.
 - ⇒ The password dialog is shown.
- 2. Enter the password and confirm.
 - ⇒ The service menu is open.

Select menu item

- In the service menu the highlighted menu item can be executed by pressing the <More Alarms> button or by opening the sub-menu.
- The buttons <▲> and <▼> highlight the next menu item.

See also

- 📖 Service menu [→ 18]

7 Alarm verification concept (AVC)

The 'Alarm Verification Concept' serves the purpose of delayed alarm transmission and takes into account the interaction of the operating personnel in the alarming sequence.

Operating personnel are able to examine the indicated fire location in the event of a fire alarm. In the event of a false alarm or ↑ minor incident, the intervention of the fire brigade can be avoided.

Information flow of 'ALARM' and 'Pre-ALARM'

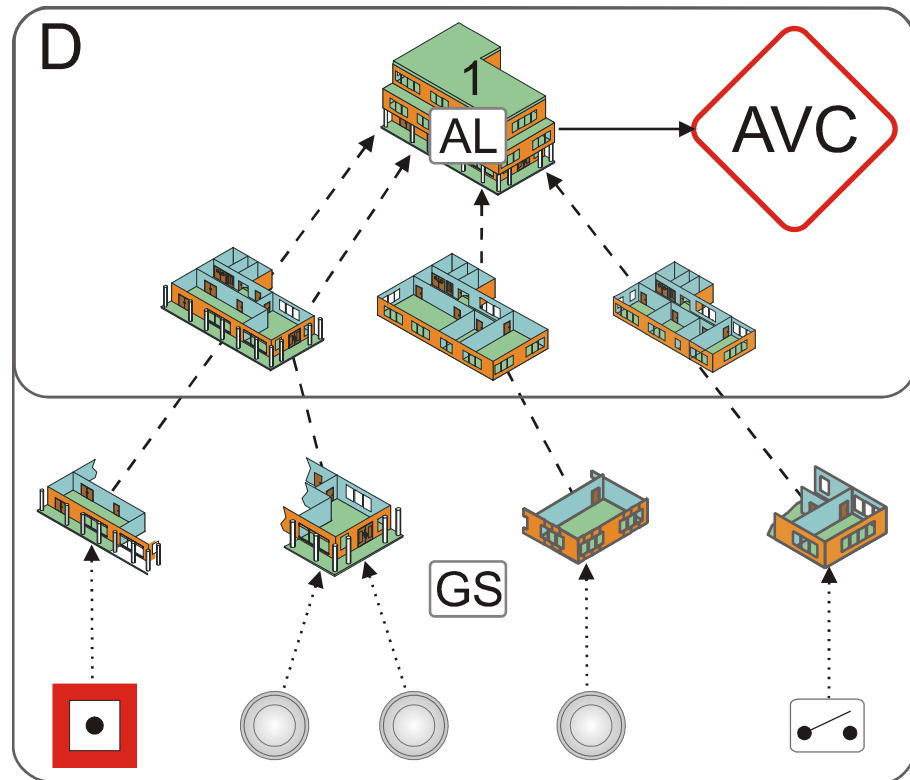

- | | | | |
|-----|----------------------------|----|-------------------------|
| D | ↑ 'Detection tree' | AL | ↑ 'Pre-ALARM' / 'ALARM' |
| AVC | Alarm verification concept | GS | ↑ Danger levels |
| 1 | ↑ 'Area' | | |

The 'Area' receives 'Pre-ALARMS' or 'ALARMS' from 'Zones'. Alarm verification takes place at 'Area' level.

Configuration for 'Pre-ALARMS' and 'ALARMS' is not related within 'AVC'. The type of verification and alarming can be separately configured for the 'Manned operation' and 'Unmanned operation' operation modes.

'ALARMS' of 'Manual zones' and 'Automatic zones' 'Zones' as well as 'Degraded FIRE ALARM' can be configured differently.



A maximum of one 'AVC' is possible per 'Area'.

7.1 Attendance check

Should an event ('Pre-ALARM', 'ALARM') arise, the operating personnel may acknowledge presence within the time t_1 . After acknowledgement, the investigation time t_2 starts. If presence is not acknowledged within the given time t_1 , \uparrow global alarming is activated.

7.2 Investigation time

During the investigation time t_2 the operating personnel may examine the indicated source of alarm and check the cause of the 'ALARM':

- Is it a real fire = Major incident?
- Is it a smoldering waste-paper basket = Minor incident?
- Has the \uparrow installation detected a deceptive phenomenon = False alarm?

In the event of a major incident (emergency), the nearest 'Manual call points' or <Alarm delay off> must be pressed. "Immediate global alarming" is then triggered.

In the case of a \uparrow minor incident or \uparrow false alarm the operator may reset the 'ALARM' and cancel alarming.



If the 'ALARM' is not reset within the given time t_2 , 'Immediate global alarming' is activated.

7.3 Example of a verification process

Alarm verification proceeds as follows:

- An alarm event activates \uparrow local alarming and starts the time t_1 for attendance check.
- Operating personnel acknowledge 'ALARM' on the operating terminal prior to the expiry of t_1 . Acknowledging normally silences local alarming (configurable feature).

If there is no acknowledgment, \uparrow global alarming is activated after the expiry of t_1 .

- After acknowledgement, the investigation time t_2 starts. During time t_2 operating personnel investigate the fire location.
 - In the case of a minor incident the operator resets the 'ALARM' at the nearest operating terminal. The alarming process stops, and no global alarming is activated.
 - In the event of a fire, the nearest 'Manual call points' or <Alarm delay off> must be pressed. 'Immediate global alarming' is triggered.

If there is no reset, 'Immediate global alarming' is also activated after the expiry of t2.

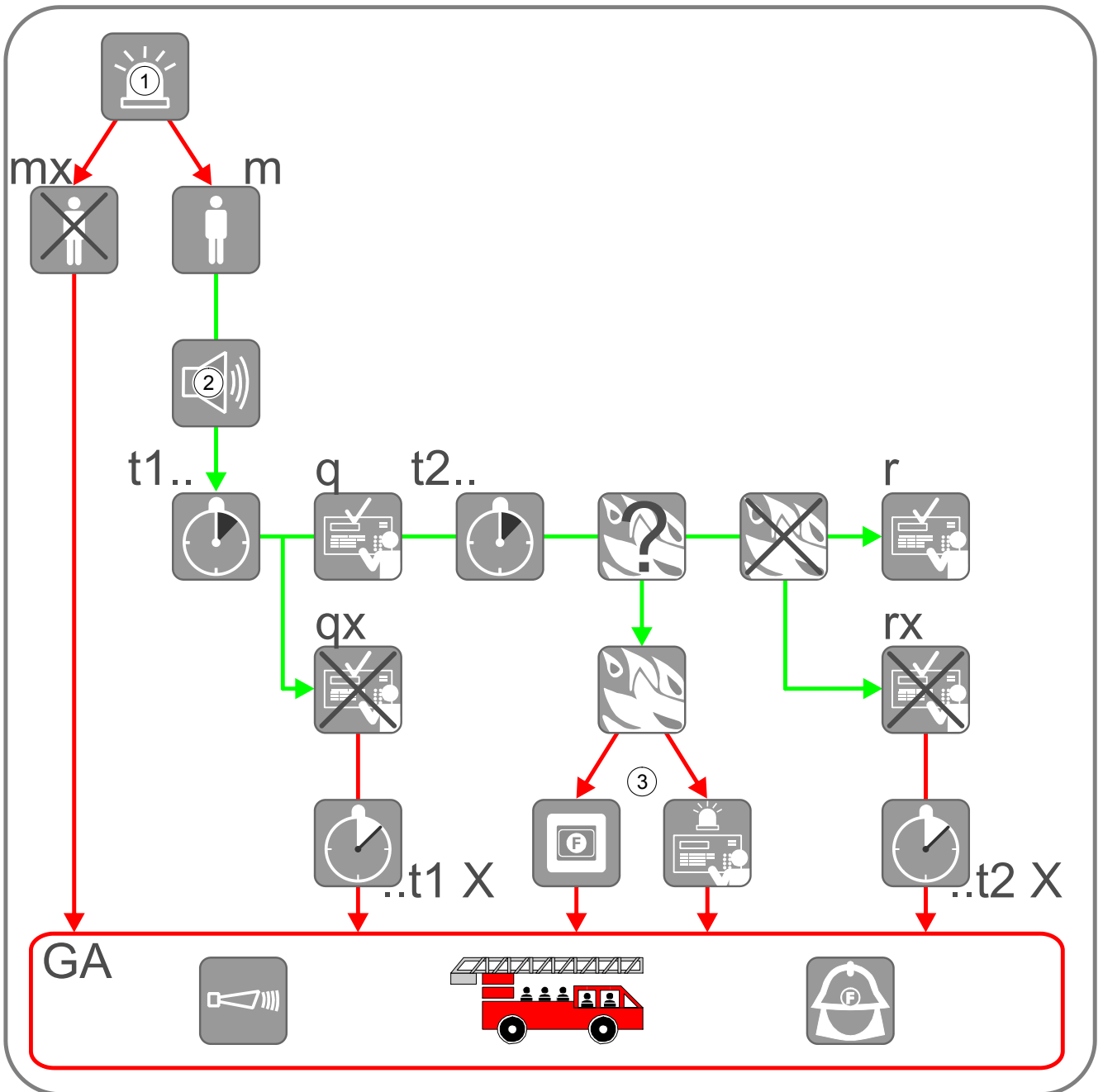

Figure 5: Alarm verification

1	Alarm event	q	Acknowledge at 'Station'
2	Local alarming	qx	Not acknowledged
3	Manual call point or <Alarm delay off> on 'Station'	t2..	Time t2 to investigate the source of alarm / the fire location
mx	'Unmanned operation' operation mode	..t2 X	Time t2 has expired
m	'Manned operation' operation mode	r	Reset on 'Station'
t1..	Time t1 for attendance check	rx	Not reset
..t1 X	Time t1 has expired	GA	Global alarming

7.4 Fire alarming

Alarming is controlled at ↑ 'Area' level. During alarming the ↑ alarming equipment is activated, e.g., ↑ alarm devices and remote transmission devices.

Alarm devices

For ↑ local and ↑ global alarming, acoustic alarm devices, beacons, digital outputs, etc., can be used. The tone of the alarm devices can be configured differently for local and global alarming (the alarm devices must be suitable for this).

Remote transmission

The alarm message is transmitted to an intervention station. In the case of local alarming, this is usually the company fire brigade and for global alarm usually the state fire brigade. A remote transmission device must be used to transmit alarm messages via the public telephone network.

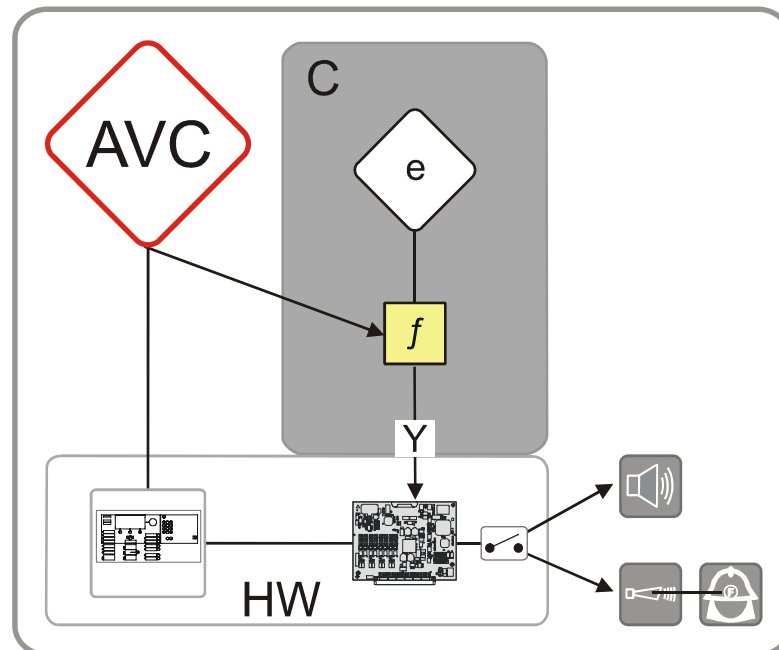

Figure 6: Information flow during alarming

AVC	'Alarm Verification Concept'	f	↑ Alarming control
C	↑ 'Control tree'	Y	Local and global alarming
e	'Alarming control group'		

The alarm devices and the remote transmission can be separately configured for:

- Alarm type (only with automatic zones)
 - 'Pre-ALARM'
 - 'ALARM'
- Zone type (only with 'ALARMS')
 - Manual alarm
 - Automatic alarm
 - Degraded fire alarm
- Operation mode:
 - 'Manned operation'
 - 'Unmanned operation'
- Alarming type:
 - 'Local alarming only'
 - 'Delayed alarming'
 - 'Global alarming only'

8 Faults / Troubleshooting

If the ↑ 'Site' displays a 'Fault', the table below provides a list of all possible 'Faults', including information on the possible causes.

If a 'Fault' cannot be eliminated with the help of these operation instructions, please contact the service engineer.

'Fault'	Cause	Remedy
'Automatic detector'	'Detector' missing	Re-insert 'Detector'
	'Detector' defective	Replace 'Detector' with replacement detector. ⚠ CAUTION! Any defective 'Detector' must always be replaced by a 'Detector' of the same type.
'Manual call point'	Glass pane broken	Replace glass pane
	Other damages	Contact service provider
'Mains failure'	'Mains failure' in the public network	No action required. Emergency power supply is ensured by batteries during at minimum 12 hours; depending on the customer specification up to 72 hours.
	Fuse damaged	Check fuses (current distributor of the building) and replace them if necessary.



With all other 'Faults', the service provider in account must be contacted.

9 Maintenance

Please adhere to the local provisions.

No maintenance work is required.

Cleaning the PMI

To clean the PMI use a wet cloth without any cleaning agents, abrasives or solvents.

Glossary

Alarm device

Element in the fire detection system for acoustic and/or visual alarming, e.g. alarm sounder, beacon.

Alarming control

Monitoring and controlling the alarming equipment

Alarming equipment

Alarm devices and remote transmissions

Area

The top level in the detection tree. Sections and zones are assigned to the area.

AVC

Abbreviation for 'Alarm Verification Concept'.

Control tree

Structure tree with control group and control.

Danger level

A fire detector signal which conveys the possibility of fire. Automatic fire detectors, for example, have danger levels 0 to 3. Manual call points only have danger levels 0 and 3. 0 = no danger, 1 = possible danger, 2 = probable danger, 3 = highly probable danger.

Detection tree

Diagram of the geographical and organizational arrangements of sensors in a building. This is a hierarchical structure comprising the area, section, and zone.

False alarm

Alarm not triggered by a danger.

Floor repeater terminal

A display device with operating elements for acknowledging and resetting alarms and faults.

Global alarming

Global alarming equipment (e.g., remote transmission) is actuated and external intervention forces (e.g., the fire brigade) are alerted.

Isolation

Status of one part of the fire detection installation, which suppresses the evaluation of all signals.

Local alarming

Local alarming equipment (e.g. acoustic or optical) is actuated in order to call up intervention personnel and to alert people of a possible fire hazard.

Minor incident

Alarm situation which the operating personnel can handle themselves and does not, therefore, trigger global alarming.



PMI

The arrangement of operating and display elements on a fire control panel or on a fire terminal. Includes the LEDs, buttons, the display, and the operation options such as the key switch, fire brigade control and display (FBA), and the EVAC NL Person Machine Interface.

Pre-alarm

Stage before an alarm for information early on, should an event occur.

Remote transmission

Remote transmission.

Section

Level in detection tree of the fire detection system. The section is assigned to the area. It is used for combining zones.

Site

Depiction of fire detection installation: The top level in the figure showing the installed system. Combines hardware tree, detection tree, and control tree.

Technical message

Events (e.g., from third-party systems) evaluated via sensors or contacts which are forwarded to the fire control panel.

Visibility

Defines which part of a site is visible and can be operated on a station.

Index

A	
Alarm verification concept	
AVC	29
Example of verification process	30
AVC	
Alarm verification concept	29
Example of verification process	30
D	
Download center	
URL	8
L	
LEDs	
Colors	17
O	
Original language	5
S	
Source language	5



Issued by
Siemens Switzerland Ltd
Building Technologies Division
International Headquarters
Theilerstrasse 1a
CH-6300 Zug
+41 58 724 2424

www.siemens.com/buildingtechnologies

© Siemens Switzerland Ltd, 2006
Technical specifications and availability subject to change without notice.