



RDF310.2, RDF310.21



RDF410.21

## Flush-mounted Room Temperature Controllers with LCD

**RDF310...**  
**RDF410...**

for 2-pipe fan coil units

for use with compressors in DX type equipment

**Output for on / off valve actuator or 1-stage compressor**

**3-speed fan control: Automatic or manual**

**Manual heating / cooling changeover or continuous Cooling only / Heating only**

**Operating modes: Normal operation, Standby**

**Adjustable commissioning and control parameters**

**Optional display of room temperature or setpoint**

**Minimum and maximum setpoint limitation**

**Operating voltage AC 230 V**

**Mounting on recessed square conduit box, fixing centres 60.3mm**

**User and parameter settings can be retained or restored with power loss**

***Additional features of RDF310.21***

**LCD backlight**

**Infrared remote control receiver**

***Additional features of RDF410.21***

**LCD backlight**

**Infrared remote control receiver**

**Auto Timer mode with 8 programmable timers**

## Use

For controlling the room temperature in individual rooms and zones that are

- heated or cooled with 2-pipe fan coil units
- cooled with a single compressor in DX type equipment

The controller controls

- a 3-speed fan
- either a valve actuator in a 2-pipe system, or
- a 1-stage compressor in DX type equipment

Suitable for use in systems with

- continuous heating or cooling mode
- manual heating / cooling changeover

## Functions

- Changeover between heating and cooling mode is manually
- Maintenance of room temperature with integrated temperature sensor
- Selection of operating mode with the operating mode button  or **Mode** on the controller
- 3-speed fan control (automatic or manual)
- Output for 2-position (on / off) valve actuator or 1-stage compressor
- 8 programmable timers for changing over between Normal operation and Economy (Energy saving) mode (RDF410.21)
- Optional with infrared remote control and LCD backlight (RDF310.21, RDF410.21)

## Applications

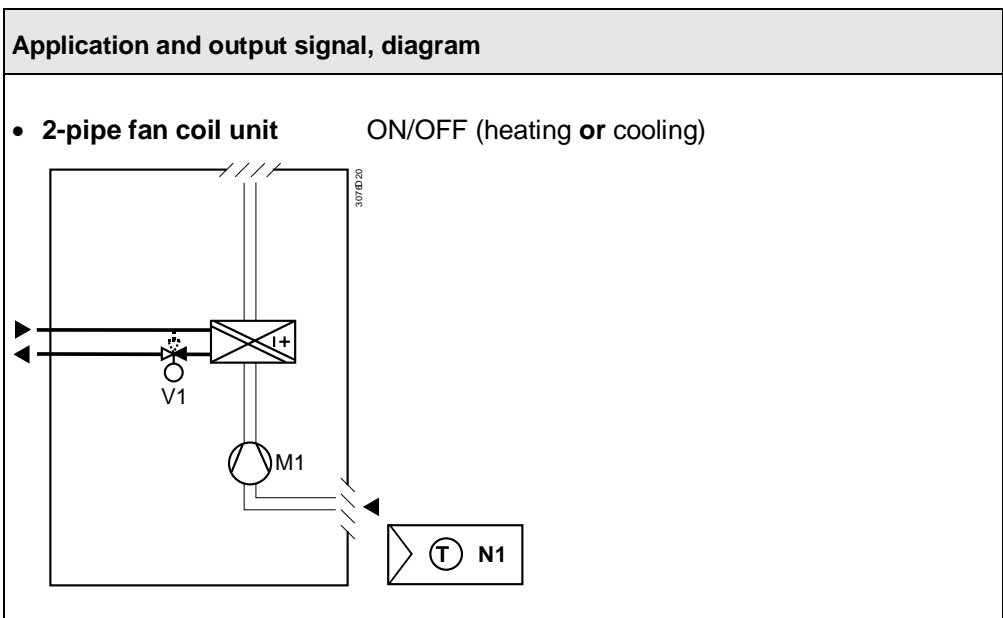

V1 Heating / cooling valve actuator

M1 3-speed fan

N1 Thermostat

## Controller

---



### Temperature control

The controller acquires the room temperature via its built-in sensor and maintains the setpoint by delivering 2-position valve control commands or compressor output commands.

The switching differential is 2 K in heating mode and 1 K in cooling mode (adjustable via parameters P08 and P09).

### Display

The display shows the acquired room temperature or the setpoint of the current operating mode. This can be selected via parameter P18. Factory setting is display of the current room temperature.

The heating  and cooling  symbols on the display show the status of the fan coil. This means that the symbols are also shown while the controller operates in the neutral zone.

If required, room temperature and setpoint can also be displayed in °F in place of °C by changing parameter P17.

## Operating modes

---

The following operating modes are available:

### Normal operation

In Normal operation, the controller maintains the setpoint, which can be adjusted via the + - buttons. The fan can be set to automatic or manual fan speed: Low, medium or high.





#### Tip!

The setpoint setting range can be limited to a minimum (P05) and maximum (P06). This helps prevent the waste of energy, thus saving costs.

### Standby

When the controller is in Standby mode , the relevant setpoints of heating or cooling are maintained. These setpoints can be adjusted via control parameters P03 and P04. Factory setting of both setpoints is OFF, which means that the controller is not activated when in Standby mode.

### Auto Timer mode (only with RDF410.21)

In Auto Timer mode , the controller will automatically change over between Normal operation and Economy (Energy saving) mode according to the 8 preprogrammed timers. The display shows the Auto Timer mode symbol  and the symbol of the operating mode currently maintained, either Normal operation  or Economy (Energy saving) mode .

### Economy (Energy saving) mode

The setpoints of Economy (Energy saving) mode can be adjusted via control parameters P01 and P02.

The default fan speed in Auto Timer mode is automatic fan.

### Avoiding damage due to moisture

To avoid damage due to moisture in very warm and humid climatic zones resulting from lack of air circulation in Economy (Energy saving) mode, the fan can be kept running all the time (e.g. in apartments or shops during unoccupied periods), when setting parameter P20 "ON in dead zone". In this case, the fan keeps running at minimum fan speed 1.

**Control sequences**

**Water-based fan coil application**

Used in conjunction with a valve, either for heating / cooling with changeover, heating only or cooling only.

**Compressor based application**

Used in conjunction with a 1-stage compressor for cooling only or heating only.

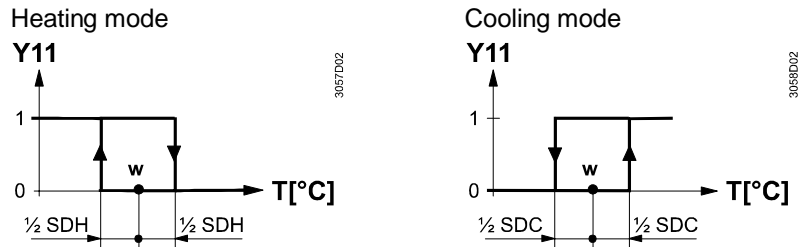

T[°C]	Room temperature	SDH	Switching differential "Heating"
W	Room temperature setpoint	SDC	Switching differential "Cooling"
Y11	Control output "Valve" or "Compressor"		

**ON**

The valve or compressor receives the **OPEN** command via control output Y11 when

1. the acquired room temperature lies by half the switching differential below the setpoint (heating mode) or above the setpoint (cooling mode), and
2. control output Y11 was not energized for more than the "Minimum output off time" (factory setting 1 minute, adjustable via parameter P16)

**OFF**

The valve or compressor receives the **CLOSE** command via control output Y11 when

1. the acquired room temperature lies by half the switching differential above the setpoint (heating mode) or below the setpoint (cooling mode), and
2. control output Y11 was energized for more than the "Minimum output on time"; (factory setting 1 minute, adjustable by parameter P15)

**Heating / cooling mode**

When pressing the heating / cooling changeover button , the controller will change from heating to cooling, or vice versa. If the controller was set to "Cooling only" or "Heating only", changeover will not be possible (parameter P22, factory setting "manual changeover"), instead NOP will flash on the display, indicating continuous cooling or heating is set respectively.

**Minimum output on time / off time Y11**

The minimum output on time and off time of Y11 can be adjusted from 1...10 minutes via parameters P15 and P16. Factory setting is 1 minute. In this case, any readjustment of the setpoint or of heating / cooling mode changeover will be used immediately for computing the output status and output Y11 may not hold the minimum on / off time of 1 minute. If parameter P15 or P16 is set to a level above 1 minute, the minimum on / off time of Y11 will be maintained as set, even if the setpoint or changeover mode has been readjusted.

## Fan operation

The fan operates either in automatic mode or at the selected speed when using manual mode. In automatic mode, the fan speed depends on the setpoint and the current room temperature. When the room temperature reaches the setpoint, the control valve will close and the fan either remains in fan speed 1 or switches off (parameter P21, factory setting: fan speed 1 in dead zone).

In "Temperature-dependent" fan control the fan switches off (see diagram below). The individual switching differentials of the fan speeds can be adjusted via control parameters P08 – P13.

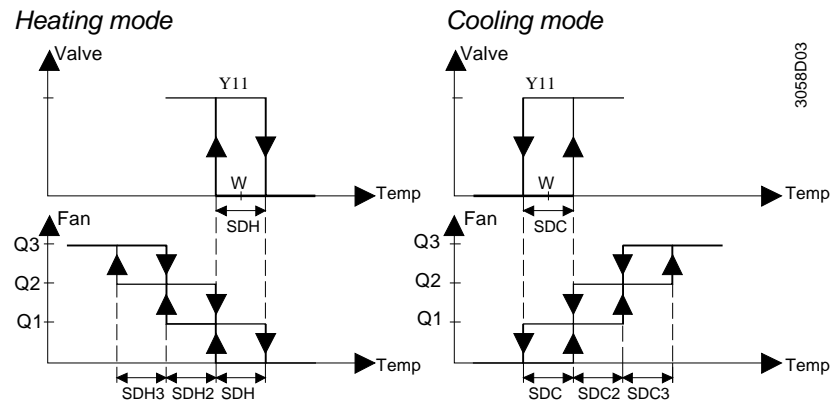

### Ventilation always on

If desired, fan control can be set to "Temperature-independent", which means that ventilation is always on, even within the dead zone, using at least fan speed 1. This can be selected individually for Normal operation using parameter P21 and for Economy (Energy saving) mode using parameter P20 (only for RDF410...; also refer to "Avoiding damage due to moisture").

### Dwelling time

In automatic mode, a dwelling time of 2 minutes (factory setting) is active. The fan maintains that speed for at least 2 minutes before it switches to the next speed. This dwelling time can be adjusted from 1...5 minutes using parameter P14.

### Fan start

Whenever the fan starts from standstill, it starts with speed 3 for 1 second in order to guarantee a safe fan motor start (to overcome inertia and friction)

### Fan in Auto Timer mode (only RDF410...)

In Auto Timer mode, the default fan mode is automatic. The fan mode can be changed to manual fan speed. With each changeover from Normal operation to Economy (Energy saving) mode, or vice versa, the fan will return to default mode automatic.

The controller provides an Auto Timer mode with 8 programmable timers. In this mode, the controller will automatically change over between Normal operation and Economy (Energy saving) mode according to the preprogrammed timers.

Auto Timer during Normal operation



Auto Timer during Economy (Energy saving) mode



### Setting the timers

Each timer has a Normal operation start time and a Normal operation end time which can be applied to several weekdays.

To adjust the time schedule, keep the **Prog** button pressed for 3 seconds to go to the programmable timer setting mode.

This mode is indicated by displaying Ax (x= auto timer 1...8) and the time xx:xx flashing.

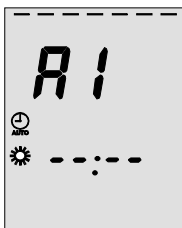

For each auto timer, proceed as follows:

1. The ☀ and 🌙 symbols are displayed. Press + or - to adjust the Normal operation start time and confirm by pressing **ok**.



2. The 🌙 and ☾ symbols are displayed. Press + or - to adjust the Normal operation end time or Economy (Energy saving) start time respectively and confirm by pressing **ok**.



- Symbol **1** will flash. Press **+** or **-** to select or deselect each day and advance to the next day. Confirm setting for actual timer by pressing **ok** and advance to the next timer.

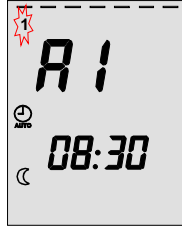

The controller will leave the programmable timer setting mode if no button is pressed within 20 seconds. All changes made after the last press of **ok** button will not be saved.

### View the timers

Press the **Prog** button to sequentially review the 8 timers.

### Default timer setting

Timers A1...A4 have the following default setting:

Day/s	Time when controller is in Normal operation	
Mo (1) – Fr (5)	06:30 – 08:30 (A1)	17:30 – 22:30 (A2)
Sa (6)	08:00 – 23:00 (A3)	
Su (7)	08:00 – 22:30 (A4)	
	- During the remaining time, controller is in Economy (Energy saving) mode - Timers A5...A8 are free, no default setting	

### Reload default timer setting

The setting of these timers can be changed to suit individual needs. The default setting can be reloaded any time:

- Set the controller to Standby .
- Press **+** and **-** simultaneously for 3 seconds. Release them and, within 2 seconds, press 2 times **Prog**.

Then, the display will show “8888” during the reloading process.

### Overlapping of timer sequences

In case two, or when several timer sequences overlap, the resulting output is the OR combination of the normal operating mode time of all timers.

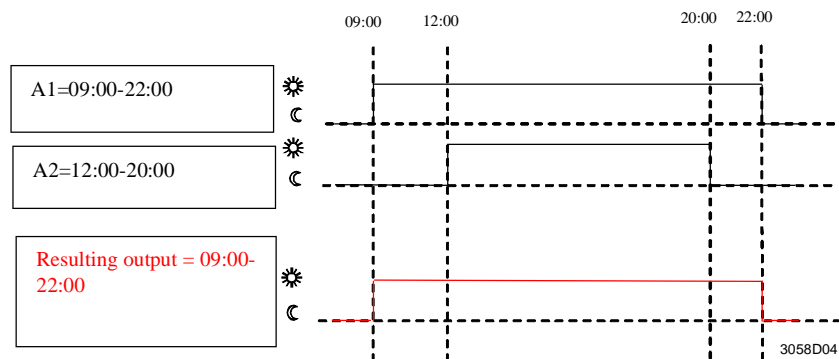

### 7day-time clock

The 7day-time clock supports the 12-hour and 24-hour format. The format is chosen during setting of the time clock as follows:

### Setting the time clock

- Keep the button depressed until the time digits start to flash and then press **+** or **-** to set the time of day. *If the current time is the 24-hour format and you wish to change to the 12-hour format, press **+** passing 23:59 or press **-** passing 00:00. Vice versa back to the 24-hour format.*
- Confirm the time of day by pressing **ok** and the weekday indicator starts to flash.

3. Press **+** or **-** to set the current weekday.
4. Confirm the current weekday by pressing **ok**.

#### Power failure

In case of a power failure, the clock will stop, but its last running time will be stored. This time information will be reloaded and start running after a power up. The clock will flash to indicate that there was a power failure until the time will be confirmed by pressing **ok** or readjusted by following the above procedure.

#### Error handling

---

##### Temperature out of range

When the room temperature is out of the measuring range, which means above 49 °C or below 0 °C, the display shows the limiting temperature in flashing figures, e.g. "0 °C" or "49 °C".

If the current setpoint is not OFF (see parameters 1-4) and the controller is in heating mode, and the temperature is below 0 °C, output Y11 will be energized. In all other cases, output Y11 will be deenergized. When the temperature returns to the measuring range, the controller will resume Normal operation.

#### Infrared remote control

---

The RDF310.21 and RDF410.21 have an infrared receiver built in. Together with the IRA210 infrared remote control, the following operations can be performed from a remote location:

- Selection of operating mode: Standby, Normal operation or Auto Timer
- Adjustment of setpoint in Normal operation
- Selection of fan mode: Automatic or manual fan speed

A buzzer in the thermostat indicates receiving of a command from the remote control

Using parameter P25, infrared remote control can be disabled.

#### Control parameters

---

A number of control parameters can be readjusted to optimize the control performance. These parameters can also be set during operation without opening the unit. In the event of a power failure, all control parameter settings will be maintained.



## Parameter settings

The parameters can be changed as follows:

1. Set the controller to Standby  $\text{⏻}$ .
2. Press buttons **+** and **-** simultaneously for 3 seconds. Release them and, within 2 seconds, press button **+** again for 3 seconds. Then, the display will show "P01".
3. Select the required parameter by repeatedly pressing buttons **+** and **-**:

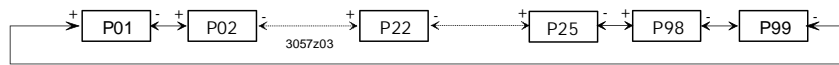

4. By pressing buttons **+** and **-** simultaneously, the current value of the selected parameter appears, which can be changed by repeatedly pressing buttons **+** or **-**.
5. By pressing buttons **+** and **-** simultaneously again or 5 seconds after the last press of a button, the last parameter will be displayed again.
6. If you wish to display and change additional parameters, repeat steps 3 through 5.
7. 10 seconds after the last display or setting, all changes will be stored and the controller returns to Standby.

## Parameter reset

The factory setting of the control parameters can be reloaded as follows:

1. Set the controller to Standby  $\text{⏻}$ .
2. Press buttons **+** and **-** simultaneously for 3 seconds. Release them and, within 2 seconds, press operating mode selector button  $\text{⏻}$  2 times.  
Then, the display will show "888" during the reloading process.

## Control parameters

Parameter	Meaning	Setting range	Factory setting
P01 <sup>1)</sup>	Setpoint of heating in Economy (Energy saving) mode ( $W_{heat_{Eco}}$ )	OFF, 5 °C... $W_{cool_{Eco}}$	16 °C
P02 <sup>1)</sup>	Setpoint of cooling in Economy (Energy saving) mode ( $W_{cool_{Eco}}$ )	OFF, $W_{heat_{Eco}}$ ...40 °C	28 °C
P03	Setpoint of heating in Standby $\text{⏻}$ ( $W_{heat_{Stb}}$ )	OFF, 5 °C... $W_{cool_{Stb}}$	OFF
P04	Setpoint of cooling in Standby $\text{⏻}$ ( $W_{cool_{Stb}}$ )	OFF, $W_{heat_{Stb}}$ ...40 °C	OFF
P05	Minimum setpoint limitation in Normal operation ( $W_{min_{Comf}}$ )	5 °C... $W_{max_{Comf}}$	5 °C
P06	Maximum setpoint limitation in Normal operation ( $W_{max_{Comf}}$ )	$W_{min_{Comf}}$ ...40 °C	35 °C
P07	Sensor calibration	-3...+3 K	0 K
P08	Switching differential heating mode SDH	0.5...+4K	2 K
P09	Switching differential cooling mode SDC	0.5...+4K	1 K
P10	Switching differential fan speed 2 in heating mode SDH2	0.5...+4K	1 K
P11	Switching differential fan speed 2 in cooling mode SDC2	0.5...+4K	1 K
P12	Switching differential fan speed 3 in heating mode SDH3	0.5...+4K	1 K
P13	Switching differential fan speed 3 in cooling mode SDC3	0.5...+4K	1 K
P14	Dwelling time of auto fan speeds	1...5 minutes	2 min
P15	Minimum output on time (Y11)	1...10 minutes	1 min
P16	Minimum output off time (Y11)	1...10 minutes	1 min
P17	Selection of °C or °F	°C or °F	°C
P18	Display of temperature or setpoint	OFF: Setpoint ON: Room (or return air) temperature	ON
P20 <sup>1)</sup>	Fan control in Economy (Energy saving) mode	OFF in dead zone ON in dead zone	OFF
P21	Fan control in Normal operation	OFF in dead zone ON in dead zone	ON
P22	Heating / cooling mode	0: Heating only 1: Cooling only 3: Manual H/C changeover	3: Manual
P25	Infrared receiver (only with RDF310.21 and RDF410.21)	0: Disabled 1: Enabled	1
	1) Only available with RDF410...		





## Type summary

Type reference	Features
<b>RDF310.2</b>	With manual heating / cooling changeover
<b>RDF310.21</b>	Same as RDF310.2 plus infrared remote control receiver <sup>1)</sup> and LCD backlight
<b>RDF410.21</b>	With manual heating / cooling changeover, 7-day time program, infrared remote control receiver <sup>1)</sup> , LCD backlight

<sup>1)</sup> Infrared remote control is to be ordered as separate item

## Equipment combinations

ON/OFF actuators

Type of unit		Product no.	Data sheet <sup>*)</sup>
Electromotoric ON/OFF actuator		<b>SFA21...</b>	4863
Electromotoric ON/OFF valve and actuator (only available in AP, UAE, SA and IN)		<b>MVI.../MXI...</b>	4867
Zone valve actuators (only available in AP, UAE, SA and IN)		<b>SUA...</b>	4832
Thermal actuator (for radiator valve)		<b>STA23...</b>	4884
Thermal actuator (for small valves 2.5 mm)		<b>STP23...</b>	4884

<sup>\*)</sup> The documents can be downloaded from <http://siemens.com/bt/download>.

## Ordering

When ordering, please give name and type reference:  
e.g. **room temperature controller RDF310.2**

The **IRA210** infrared remote control is to be ordered as separate item

Valve actuators are to be ordered as separate items.

The controller consists of two parts:

- Front panel which accommodates the electronics, the operating elements and the built-in room temperature sensor
- Mounting base with the power electronics

The mounting base carries on the rear side the screw terminals. It fits on a square conduit box with fixing centres 60.3mm. The front panel engages in the mounting base and snaps on.

Setting and operating elements

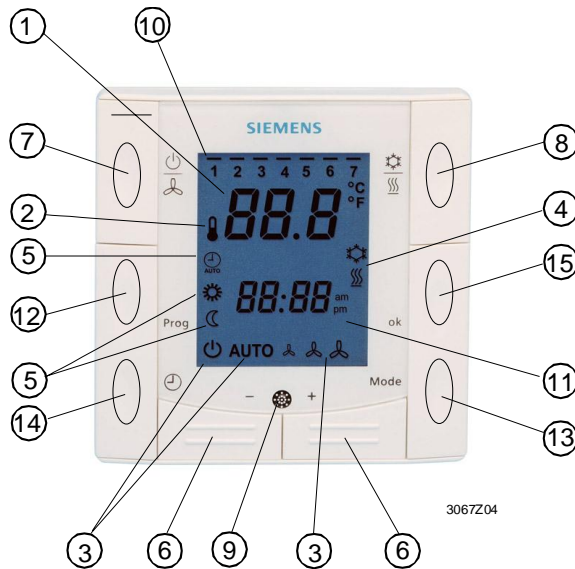

Legend

- 1 Display of the room temperature, setpoints and control parameters
- 2 Symbol used when displaying the current room temperature
- 3 Standby / fan mode status  
 Standby mode  
**AUTO** Auto fan active  
 fan speed low, medium, high
- 4 in cooling mode  
 in heating mode
- 5 Auto Timer mode  
 Normal operation  
 Economy (Energy saving) mode
- 6 Buttons for adjusting the setpoints, control parameters and time of day
- 7 Button for changing fan operation and Standby ()
- 8 Manual heating / cooling changeover ()
- 9 Infrared receiver (only with RDF310.21, RDF410.21)

Only on RDF410...

- 10 Weekday 1..7 (1 = Monday / 7 = Sunday)
- 11 Current time of day
- 12 Auto timer program (**Prog**)
- 13 Button operating mode (**Mode**): Normal operation / Auto Timer mode
- 14 Button for setting time of day and weekday ()
- 15 Confirmation (**ok**)

## Mounting and installation

---

The room controller can be mounted on a recessed square conduit box with fixing centres of 60.3mm. The mounting location on a wall should not be in niches or bookshelves, not behind curtains, above or near heat sources and not exposed to direct solar radiation. Mounting height is about 1.5 m above the floor.

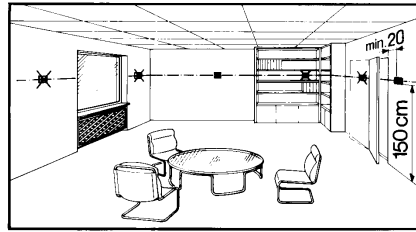

### Wiring



Also refer to the Mounting Instructions B3067 enclosed with the controller.

- Wiring, protection and earthing must be installed in compliance with local regulations.
- The cables to the controller, fan and valves carry AC 230 V mains voltage and must be appropriate sized
- Only valves rated for AC 230 V may be used
- The AC 230 V mains supply line must have an external fuse or circuit breaker with a rated current of no more than 10 A

#### **Warning!**

#### **No internal line protection for supply lines to external consumers (Q1, Q2, Q3, Y11)**

Risk of fire and injury due to short-circuits!

- Adapt the line diameters as per local regulations to the rated value of the installed overcurrent protection device.

### Commissioning

After applying power, the controller makes a reset during which all LCD segments flash, indicating that the reset has been correctly made. This takes about 3 seconds. Then, the controller is ready for commissioning by qualified HVAC staff. The control parameters of the controller can be set to ensure optimum performance of the whole system (also refer to "Setting the control parameters").

### Heating / cooling mode

- Depending on the application, the heating / cooling mode must be set via parameter P22. Factory setting is "Manual heat/cool changeover". When using in "Cooling only" or "Heating only", P22 must be set accordingly.

### Compressor-based application

- If the controller is used in conjunction with a compressor, the minimum output on time (parameter P15) and off time (parameter P16) of Y11 must be adjusted in order not to harm the life time of the compressor

### Calibrating the sensor

- If the room temperature displayed by the controller does not accord with the room temperature effectively measured, the temperature sensor can be recalibrated. In that case, parameter P07 must be changed

### Setpoint and range limitation

- For comfort and energy saving reasons, it is suggested to review the setpoints and setpoint ranges (parameters P01...P06) and, if necessary, to change them accordingly

## Disposal



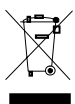





---



The devices are considered electronics devices for disposal in term of European Directive 2012/19/EU and may not be disposed of as domestic waste.

- Dispose of the device via the channels provided for this purpose.
- Comply with all local and currently applicable laws and regulations.

## Technical data

 Power supply	Operating voltage	AC 230 V +10/-15 %
	Frequency	50/60 Hz
	Power consumption	max. 8 VA
	<b>No internal fuse</b>	
	External preliminary protection with max. C 10 A circuit breaker in the supply line required under all circumstances	
Outputs	Fan control Q1, Q2, Q3-N	AC 230 V
	Rating	5 mA...4(2)A
	Control output Y11-N (N.O.)	AC 230 V
Inputs	Rating	5 mA...4(2)A
	Infrared receiver (only with RDF310.21 and RDF410.21)	
	Transmission distance	≤ 7.5 m
Operational data	Orientation angle	≤ ± 30 °
	Switching differential, adjustable from 0.5...4K	
	Heating mode (factory setting)	2 K
	Cooling mode (factory setting)	1 K
	Setpoint setting range	
	 Normal operation	5...40 °C
	 Economy (Energy saving) mode (RDF410..)	off, 5...40 °C
	 Standby	off, 5...40 °C
	Factory setting of setpoints	
	 Normal operation	20 °C
	 Economy (Energy saving) in heating / cooling mode	16 °C / 28 °C
	 Standby (heating and cooling mode)	OFF
	Built-in room temperature sensor	
	Measuring range	0...49 °C
	Accuracy at 25 °C	< ± 0.5 K
Temperature calibration range	± 3.0 K	
Resolution of settings and display		
Setpoints	0.5 °C	
Current temperature value displayed	0.5 °C	
Environmental conditions	Operation	to IEC 60721-3-3
	Climatic conditions	class 3K5
	Temperature	0...+50 °C
	Humidity	<95 % r.h.
	Transport	to IEC 60721-3-2
	Climatic conditions	class 2K3
	Temperature	-25...+60 °C
	Humidity	<95 % r.h.
	Mechanical conditions	class 2M2
	Storage	to IEC 60721-3-1
	Climatic conditions	class 1K3
	Temperature	-25...+60 °C
Humidity	<95 % r.h.	
Norms and standards	EU Conformity (CE)	CE1T3067xx <sup>1)</sup>
	RCM Conformity	CE1T3067en C1
	Devices of safety class	II to EN 60730-1
	Pollution class	normal
	Degree of protection of housing	IP 30 to EN 60529
Environmental compatibility	The product environmental declaration CE1E3067 <sup>1)</sup> contains data on environmentally compatible product design and assessments (RoHS compliance, materials composition, packaging, environmental benefit, disposal).	

General

Connection terminals	solid wires or prepared stranded wires 1x0.4-1.5 mm <sup>2</sup>
Weight	0.17 kg
Color of housing front	white, RAL 9003

\*) The documents can be downloaded from <http://siemens.com/bt/download>.

**Connection terminals**

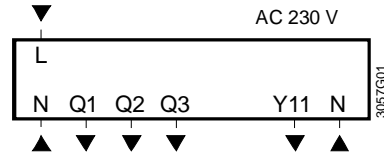

- L, N Operating voltage AC 230 V
- Q1 Control output "Fan speed 1 AC 230 V
- Q2 Control output "Fan speed 2 AC 230 V
- Q3 Control output "Fan speed 3 AC 230 V
- Y11 Control output "Valve" AC 230 V (N.O., for normally closed valves) or output for compressor

**Connection diagrams**

Application:

**2-pipe fan coil units**

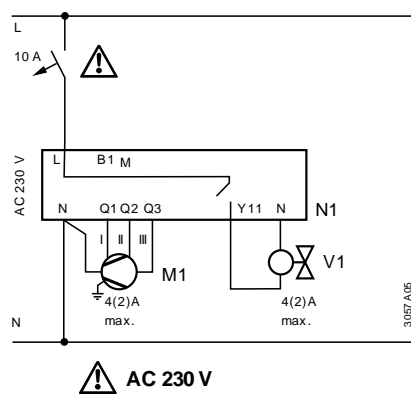

- M1 3-speed fan
- N1 Room temperature controller RDF310.../RDF410...
- V1 Zone valve

Application:

**Compressor in DX type equipment**

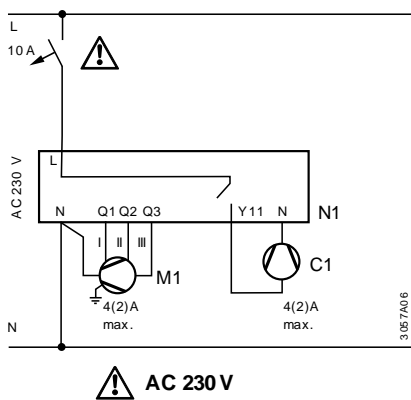

- M1 3-speed fan
- N1 Room temperature controller RDF310.../RDF410...
- C1 Compressor

## Dimensions

---

