



RDF110
RDF110/IR



RDF110.2
RDF110.2/IR

Room Temperature Controllers with LCD

RDF110...

for 2-pipe fan coil units

for compressors in DX type equipment

Output for on / off valve actuator or 1-stage compressor

3-speed fan control: Automatic or manual

Adjustable commissioning and control parameters

Optional display of room temperature or setpoint

Minimum and maximum setpoint limitation

Operating voltage AC 230 V

Additional features of RDF110

Automatic heating / cooling changeover

Operating modes: Normal operation, Economy (Energy saving) and Protection (Standby)

Input for heating / cooling changeover or return air temperature sensor

Potential-free input for operating mode changeover (key card contact, etc.)

Function for avoiding damage resulting from moisture

Additional features of RDF110.2

Manual heating / cooling changeover

Operating modes: Normal operation, Protection (Standby)

Optional

Infrared remote control (RDF110/IR, RDF110.2/IR)

Use

For controlling the room temperature in individual rooms and zones that are

- heated or cooled with 2-pipe fan coil units
- cooled with a single compressor in DX type equipment

The controller controls

- a 3-speed fan
- either a valve actuator in a 2-pipe system, or
- a 1-stage compressor in DX type equipment

Suitable for use in systems with

- automatic heating / cooling changeover (RDF110)
- continuous heating or cooling mode (RDF110)
- manual heating / cooling changeover (RDF110.2)

Functions

- Changeover between heating and cooling mode is either automatic by a QAH11.1 changeover cable temperature sensor or manually
- Maintenance of room temperature either with integrated temperature sensor or external room / return air temperature sensor (only with RDF110 and RDF110/IR)
- Selection of operating mode with an external changeover switch (only with RDF110 and RDF110/IR) or with the operating mode button  on the controller
- 3-speed fan control (automatic or manual)
- Output for 2-position (on / off) valve actuator or 1-stage compressor
- Optional with infrared remote control (only with RDF110.../IR)



Controller

Temperature control

The controller acquires the room temperature via its built-in sensor and maintains the setpoint by delivering 2-position valve control commands or compressor output commands. With the RDF110, an external room temperature sensor (QAA32) or external return air temperature sensor (QAH11.1) can be used instead. The switching differential is 2 K in heating mode and 1 K in cooling mode (adjustable via parameters P08 and P09).

Display

The display shows the acquired room / return air temperature or the setpoint of the current operating mode. This can be selected via parameter P18. Factory setting is display of the current room temperature.



The heating  and cooling  symbols on the display show the status of the fan coil. This means that the symbols are also shown while the controller operates in the neutral zone.

If required, room temperature and setpoint can also be displayed in °F in place of °C by changing parameter P17.

Operating modes

The following operating modes are available:

Normal operation

In Normal operation, the controller maintains the setpoint, which can be adjusted via the   buttons. The fan can be set to automatic or manual fan speed: Low, medium or high.

Tip!

The setpoint setting range can be limited to a minimum (P05) and maximum (P06). This helps prevent the waste of energy, thus saving costs.

Economy (Energy saving) mode 
(only with RDF110 and RDF110/IR)

When external operating mode changeover is activated, the controller switches to Economy (Energy saving) mode. In this operating mode, the relevant setpoints of heating or cooling are maintained. These setpoints can be adjusted via control parameters P01 and P02. The default fan speed in Economy (Energy saving) mode is automatic fan.

Protection (Standby)

When the controller is in Protection (Standby) mode , the relevant setpoints of heating or cooling are maintained. These setpoints can be adjusted via control parameters P03 and P04. Factory setting of both setpoints is OFF, which means that the controller is not activated when in Protection (Standby) mode.

Avoiding damage due to moisture
(only with RDF110 and RDF110/IR)

To avoid damage due to moisture in very warm and humid climatic zones resulting from lack of air circulation in Economy (Energy saving) mode, the fan can be kept running all the time (e.g. in hotel rooms during unoccupied periods), when setting parameter P20 to "ON in dead zone". In this case, the fan keeps running at minimum fan speed 1.

Control sequences

Water-based fan coil application

Used in conjunction with a valve, either for heating / cooling with changeover, heating only or cooling only.

Compressor-based application

Used in conjunction with a 1-stage compressor for cooling only or heating only.

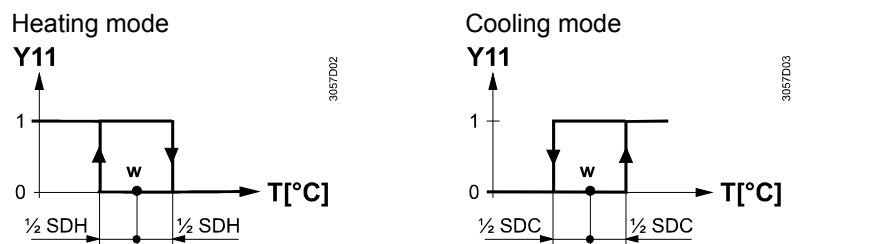

T [°C]	Room temperature	SDH	Switching differential "Heating"
W	Room temperature setpoint	SDC	Switching differential "Cooling"
Y11	Control output "Valve" or "Compressor"		

ON

The valve or compressor receives the **OPEN** command via control output Y11 when

1. the acquired room temperature lies by half the switching differential below the setpoint (heating mode) or above the setpoint (cooling mode), and
2. control output Y11 was not energized for more than the "Minimum output off time" (factory setting 1 minute, adjustable via parameter P16)

OFF

The valve or compressor receives the **CLOSE** command via control output Y11 when

1. the acquired room temperature lies by half the switching differential above the setpoint (heating mode) or below the setpoint (cooling mode), and
2. control output Y11 was energized for more than the "Minimum output on time"; (factory setting 1 minute, adjustable by parameter P15)

Note:

Control output Y12 delivers a control command which is inverted to the control command at output Y11 and which can be used for normally open valves.

Heating / cooling mode

With the RDF110, the changeover between cooling and heating takes place either automatically via a heating / cooling changeover sensor or a remote changeover switch. If the controller was set to "Cooling only" or "Heating only", changeover will not be possible (parameter P22, factory setting "Cooling only").

With the RDF110.2, when pressing the heating / cooling changeover button , the controller will change from heating to cooling, or vice versa.

Minimum output on time / off time Y11

The minimum output on time and off time of Y11 can be adjusted from 1...10 minutes via parameters P15 and P16. Factory setting is 1 minute. In this case, any readjustment of the setpoint or of heating / cooling mode changeover will be used immediately for computing the output status and output Y11 may not hold the minimum on / off time of 1 minute.

If parameter P15 or P16 is set to a level above 1 minute, the minimum on / off time of Y11 will be maintained as set, even if the setpoint or changeover mode has been readjusted.

Fan operation

The fan operates either in automatic mode or at the selected speed when using manual mode. In automatic mode, the fan speed depends on the setpoint and the current room temperature. When the room temperature reaches the setpoint, the control valve will close and the fan switch off: Temperature-dependent fan control (see diagram below). The individual switching differentials of the fan speeds can be adjusted via control parameters P08 – P13.

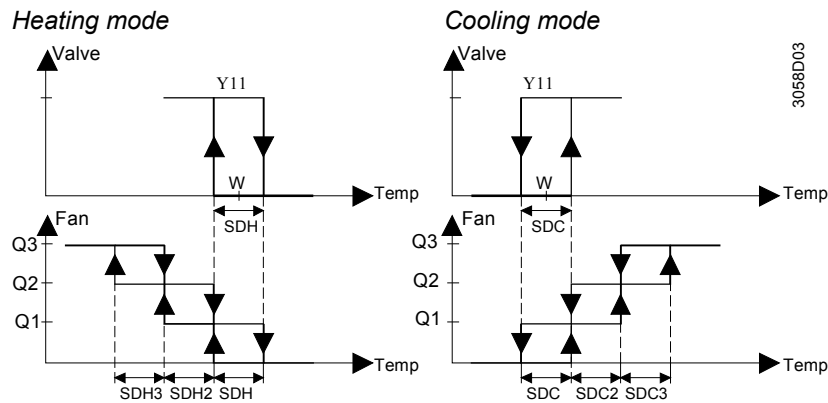

Ventilation always on

If desired, fan control can be set to "Temperature-independent", which means that ventilation is always on, even within the dead zone, using at least fan speed 1. This can be selected individually for Normal operation using parameter P21 and for Economy (Energy saving) mode using parameter P20 (also refer to "Avoiding damage due to moisture").

Dwelling time

In automatic mode, a dwelling time of 2 minutes (factory setting) is active. The fan maintains that speed for at least 2 minutes before it switches to the next speed. This dwelling time can be adjusted from 1...5 minutes using parameter P14.

Fan start

When the fan starts from standstill, it starts with fan speed 3 for 1 second in order to guarantee a safe fan motor start (to overcome inertia and friction).

External sensor input B1-M



With the RDF110, a return air / external room temperature sensor or heating / cooling changeover sensor can be connected to terminal B1-M. The function of this sensor input is determined by parameter P22.

Sensor input B1-M is not galvanically separated from the AC 230 V mains supply. Therefore, only a cable temperature sensor and wiring with sufficient insulation must be used.

Automatic heating / cooling changeover

When P22 is set to “Automatic H/C changeover”, the sensor input acts to ensure automatic heating / cooling changeover. The water temperature acquired by the changeover sensor (QAH11.1 + ARG86.3) is used to switch from heating to cooling mode, or vice versa. When the water temperature lies above 28 °C (parameter P24), the controller switches to heating mode; below 16 °C (parameter P23), it switches to cooling mode. If, immediately after switching on, the water temperature lies between the 2 changeover points, the controller will start in heating mode. The water temperature is acquired at 30-second intervals and the operating state is updated.

Automatic H / C changeover

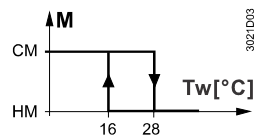

M Operating mode CM Cooling mode
 Tw Water temperature HM Heating mode

Remote heating / cooling changeover

The QAH11.1 cable temperature sensor for automatic heating / cooling changeover can be replaced by an external switch (suited for mains voltage) for manual remote changeover:

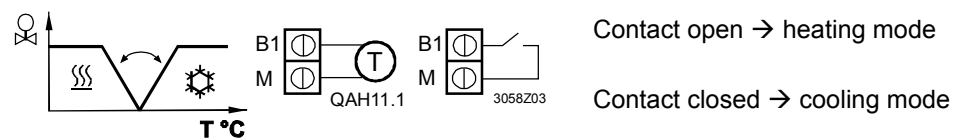

With parameter P99 (diagnostic value), automatic heating / cooling changeover can be checked.

External room or return air temperature sensor

When parameter P22 is set to “Cooling only” or “Heating only”, sensor input B1-M can be used to connect an external room temperature (QAA32) or a return air temperature sensor (QAH11.1). Changeover is automatic if a sensor is detected at the sensor input. With parameter P98 (diagnostic value), the sensor status can be checked.

Summary B1-M and P22

The following table summarizes the relation between parameter P22, the external sensor B1-M and variables which the controller uses for maintaining the temperature:

Parameter P22	Variables: The controller....	No sensor at B1-M	QAH11.1/QAA32 at B1-M
Heating only	is in H/C mode	Heating	Heating
	controls according to	Internal sensor	Sensor at B1
Cooling only	is in H/C mode	Cooling	Cooling
	controls according to	Internal sensor	Sensor at B1
Automatic H/C changeover	is in H/C mode	Heating	depending on the temperature of sensor B1-M
	controls according to	Internal sensor	Internal sensor

External operating mode changeover D1-GND

With the RDF110, a potential-free operating mode changeover switch (window switch, key card contact, etc.) can be connected to status input D1-GND. No additional power supply is required for detecting the position of the external switch.

When the switch closes due to an open window, or unoccupied hotel room for instance, the operating mode will change to Economy (Energy saving). During this external operating mode changeover, neither the setpoint nor the control parameter nor fan mode can be changed. When pressing the setpoint or fan mode buttons, ECO will flash on the display, indicating that the operating mode is overridden from a remote location.

The operating action of the switch (N.C. or N.O.) can be selected via parameter P19.

Error handling

Temperature out of range

When the room temperature is out of the measuring range, which means above 49 °C or below 0 °C, the display shows the limiting temperature in flashing figures, e.g. "0 °C" or "49 °C".

If the current setpoint is not OFF (see parameters 1 – 4), the controller is in heating mode and the temperature is below 0 °C, output Y11 will be energized. In all other cases, Y11 is deenergized. When the temperature returns to the measuring range, the controller will resume Normal operation.

External sensor failure

In case of an external sensor failure (short-circuit or open-circuit), the controller will immediately switch back to the internal sensor to ensure control.

Should both the external and internal sensor fail, the display will flash "Err" to call the user's attention.

Infrared remote control

The RDF110/IR and RDF110.2/IR have an infrared receiver built in. Together with the IRA210 infrared remote control, the following operations can be performed from a remote location:

- Selection of operating mode: Protection (Standby) / Normal operation
- Adjustment of setpoint in Normal operation
- Selection of fan mode: Automatic or manual fan speed

Using parameter P25, infrared remote control can be disabled.

Control parameters

With the RDF110 and RDF110.2, a number of control parameters can be readjusted to optimize the control performance. These parameters can also be set during operation without opening the unit. In the event of a power failure, all control parameter settings will be maintained.

Parameter settings

The parameters can be changed as follows:

1. Set the controller to Protection (Standby) (⏻).
2. Press buttons \uparrow and \downarrow simultaneously for 3 seconds. Release them and, within 2 seconds, press button \uparrow again for 3 seconds. Then, the display will show "P01".
3. Select the required parameter by repeatedly pressing buttons \uparrow and \downarrow :

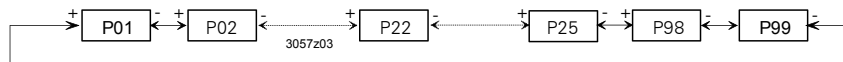

4. By pressing buttons \uparrow and \downarrow simultaneously, the current value of the selected parameter appears, which can be changed by repeatedly pressing buttons \uparrow or \downarrow .
5. By pressing buttons \uparrow and \downarrow simultaneously again or 5 seconds after the last press of a button, the last parameter will be displayed again.
6. If you wish to display and change additional parameters, repeat steps 3 through 5.
7. 10 seconds after the last display or setting, all changes will be stored and the controller returns to Protection (Standby).

Note:

Parameters not used by the RDF110.2 are not available and cannot be displayed.

Parameter reset

The factory setting of the control parameters can be reloaded as follows:

1. Set the controller to Protection (Standby) (⏻).
2. Press buttons \uparrow and \downarrow simultaneously for 3 seconds. Release them and, within 2 seconds, press operating mode selector button $\mathcal{L}/\text{⏻}$ 2 times.

Then, the display will show "888" during the reloading process.

Control parameters of the RDF110 and RDF110.2

Parameter	Meaning	Setting range	Factory setting
P01	Setpoint of heating in Economy (Energy saving) mode (Wheat _{Eco})	OFF, 5 °C...Wcool _{Eco}	16 °C ¹⁾
P02	Setpoint of cooling in Economy (Energy saving) mode (Wcool _{Eco})	OFF, Wheat _{Eco} ...40 °C	28 °C ¹⁾
P03	Setpoint of heating in Protection (Standby) (⚠) (Wheat _{Stb})	OFF, 5 °C...Wcool _{Stb}	OFF
P04	Setpoint of cooling in Protection (Standby) (⚠) (Wcool _{Stb})	OFF, Wheat _{Stb} ...40 °C	OFF
P05	Minimum setpoint limitation in Normal operation (Wmin _{Comf})	5 °C...Wmax _{Comf}	5 °C
P06	Maximum setpoint limitation in Normal operation (Wmax _{Comf})	Wmin _{Comf} ...40 °C	35 °C
P07	Sensor calibration	-3...+3 K	0 K
P08	Switching differential heating mode SDH	0.5...+4K	2 K
P09	Switching differential cooling mode SDC	0.5...+4K	1 K
P10	Switching differential fan speed 2 in heating mode SDH2	0.5...+4K	1 K
P11	Switching differential fan speed 2 in cooling mode SDC2	0.5...+4K	1 K
P12	Switching differential fan speed 3 in heating mode SDH3	0.5...+4K	1 K
P13	Switching differential fan speed 3 in cooling mode SDC3	0.5...+4K	1 K
P14	Dwelling time of auto fan speeds	1...5 minutes	2 min
P15	Minimum output on time (Y11)	1...10 minutes	1 min
P16	Minimum output off time (Y11)	1...10 minutes	1 min
P17	Selection of °C or °F	°C or °F	°C
P18	Display of temperature or setpoint	OFF: Setpoint ON: Room (or return air) temperature	ON
P19	Operating action of remote changeover input	0: Normally open (N.O) 1: Normally closed (N.C.)	0 ¹⁾
P20	Fan control in Economy (Energy saving) mode	OFF in dead zone ON in dead zone	OFF ¹⁾
P21	Fan control in Normal operation	OFF in dead zone ON in dead zone	OFF
P22	Heating / cooling mode	0: Heating only 1: Cooling only 2: Automatic H/C changeover	1: Cooling only ¹⁾
P23	Heating / cooling changeover switching point cooling	10...25 °C	16 °C ¹⁾
P24	Heating / cooling changeover switching point heating	27...40 °C	28 °C ¹⁾
P25	Infrared receiver (only with RDF.../IR)	0: Disabled 1: Enabled	1
P98	Active temperature sensor	0: Internal sensor 1: External sensor	Diagnostic value ¹⁾
P99	Value of current heating / cooling changeover temperature reading and indication of current mode	100 = input open → ∞ mode 0...49 °C = cur. temp. value 00 = input bridged → ⚙ mode OFF= not commissioned as automatic H/C changeover	Diagnostic value ¹⁾

1) Not available with RDF110.2

Type summary

Type	Features
RDF110	With input for automatic heating / cooling changeover or return air temperature sensor With input for operating mode changeover
RDF110.2	With manual heating / cooling changeover Without input for sensor Without input for operating mode changeover
RDF110/IR^{*)}	Same as RDF110 plus infrared remote control
RDF110.2/IR^{*)}	Same as RDF110.2 plus infrared remote control

*) Type is not orderable any more

Equipment combinations

Type of unit	Type	Data Sheet ^{*)}
Infrared remote control	IRA210	-
Cable temperature sensor	QAH11.1	1840
Room sensor	QAA32	1747
Changeover mounting kit	ARG86.3	1840
Electromotoric on / off valve and actuator	MVI.../MXI...	4867
Electromotoric on / off actuator	SFA21...	4863
Thermal actuator (for radiator valve)	STA21...	4893
Thermal actuator (for small valves 2.5 mm)	STP21...	4878
Zone valve actuators (only available in AP, UAE, SA and IN)	SUA...	4830

*) The documents can be downloaded from <http://siemens.com/bt/download>.

Accessories

Description	Type
Adapter plate 120 x 120 mm for 4" x 4" conduit boxes	ARG70
Adapter plate 96 x 120 mm for 2" x 4" conduit boxes	ARG70.1
Adapter plate for surface wiring 112 x 130 mm	ARG70.2

Ordering

When ordering, please provide name and type:

E.g. **room temperature controller RDF110**

The **IRA210** infrared remote control is to be ordered as a separate item

The **QAH11.1** can be used as a return air temperature or automatic heating / cooling changeover sensor. In case it is used as a changeover sensor, the **ARG86.3** changeover sensor mounting kit is to be ordered as a separate item.

Valve actuators are to be ordered as separate items.

Mechanical design

The controller consists of two parts:

- Plastic housing which accommodates the electronics, the operating elements and the built-in room temperature sensor
- Mounting base



The housing engages in the mounting base and snaps on.

The base carries the screw terminals.

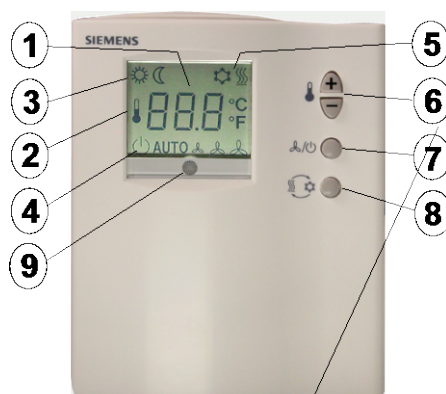
Setting and operating elements



Legend

- 1 Display of the room temperature, setpoints and control parameters
- 2 || Symbol used when displaying the current room temperature
- 3 Operating mode
 - ☀ Normal operation
 - ☾ Economy (Energy saving) mode
- 4 Protection (Standby) / fan mode status
 - ⏻ Protection (Standby) mode
 - AUTO** Auto fan active
 - 🌀 fan speed low, medium, high
- 5  in cooling mode
 in heating mode
- 6 Buttons for adjusting the setpoints and the control parameters
- 7 Button for changing fan operation and Protection (Standby) (🌀/⏻)
- 8 Manual heating / cooling changeover (☀/☾) (only with RDF110.2)
- 9 Infrared receiver (only with RDF110.../IR)

Mounting and installation

The room controller can be mounted on a wall or inside the fan coil unit. The mounting location on a wall should not be in niches or bookshelves, not behind curtains, above or near heat sources and not exposed to direct solar radiation. Mounting height is about 1.5 m above the floor.

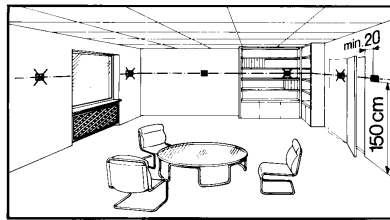

The controller can be fitted on a recessed conduit box.

When using a heating / cooling changeover sensor, then, before fitting the sensor, thermal conductive paste must be applied to the location on the pipe where the sensor is placed.

Wiring



Also refer to the Mounting Instructions B3057 enclosed with the controller.

- Wiring, protection and earthing must be installed in compliance with local regulations. It must be made certain that safety extra low-voltage lines (SELV circuit) are clearly separated from AC 230 V mains voltage cable
- The cables to the controller, external sensor, fan and valves carry AC 230 V mains voltage and must be appropriate sized
- Only sensors and valves rated for AC 230 V may be used
- The AC 230 V mains supply line must have a circuit breaker with a rated current of no more than C 10 A



Warning!

No internal line protection for supply lines to external consumers (Q1, Q2, Q3, Y11, Y12)

Risk of fire and injury due to short-circuits!

- Adapt the line diameters as per local regulations to the rated value of the installed overcurrent protection device.
- Maximum 10 changeover contact inputs B1-M can be connected in parallel if an external switch is used in place of a changeover sensor. The switch must be suited for AC 230 V. The cable length must not exceed 80 m overall
- Maximum 10 operating mode changeover contact inputs D1-GND can be connected in parallel. The cable length must not exceed 80 m overall



Commissioning

After applying power, the controller makes a reset during which all LCD segments flash, indicating that the reset has been correctly made. This takes about 3 seconds. Then, the controller is ready for commissioning by qualified HVAC staff. The control parameters of the controller can be set to ensure optimum performance of the whole system (also refer to "Setting the control parameters").

Heating / cooling mode

- Only with RDF110: Depending on the application, the heating / cooling mode needs to be set via parameter P22. Factory setting is "Cooling only". When using the "Automatic heating / cooling changeover" function, P22 must be set to "Automatic H/C changeover".

Note: When P22 is set to "Automatic H/C changeover", the built-in sensor is used for acquiring the room temperature

Compressor-based application

- If the controller is used in conjunction with a compressor, the minimum output on time (parameter P15) and off time (parameter P16) of Y11 must be adjusted in order not to harm the life time of the compressor

Calibrating the sensor

- If the room temperature displayed by the controller does not accord with the room temperature effectively measured, the temperature sensor can be recalibrated. In that case, parameter P07 must be changed

Setpoint and range limitation

- For comfort and energy saving reasons, it is suggested to review the setpoints and setpoint ranges (parameters P01...P06) and, if necessary, to change them accordingly

Diagnostic values

- Only with RDF110: Parameters P98 and P99 are diagnostic values and help check the system. With P98, the status of the active temperature sensor is shown and, with P99, the status of the heating / cooling changeover sensor

Disposal



The devices are considered electronics devices for disposal in term of European Directive 2012/19/EU and may not be disposed of as domestic waste.

- Dispose of the device via the channels provided for this purpose
- Comply with all local and currently applicable laws and regulations.

Technical data

Power supply

Operating voltage	AC 230 V +10/-15 %
Frequency	50/60 Hz
Power consumption	max. 8 VA



No internal fuse

External preliminary protection with max. C 10 A circuit breaker in the supply line required under all circumstances

Outputs

Fan control Q1, Q2, Q3-N	AC 230 V
Rating	5 mA...4(2)A
Control output Y11-N (N.O.) / Y12-N (N.C.)	AC 230 V
Rating	5 mA...4(2)A

Inputs



Changeover or external room temperature sensor B1-M	
Temperature sensor	QAH11.1, safety class II
Voltage against earth	AC 230 V
Cable length	max. 80 m (min. 1.5 mm ²)
Status input D1 and GND	
Contact sensing	SELV DC 6...15 V / 3...6 mA
Insulation against mains	4 kV, reinforced insulation
Operating action	selectable (N.O. / N.C.)
Cable length	max. 80 m (min. 1.5 mm ²)
Infrared receiver (only with RDF110.../IR)	
Transmission distance	≤ 7.5 m
Orientation angle	≤ ± 30 °

Operational data	Switching differential, adjustable from 0.5..4 K	
	Heating mode (factory setting)	2 K
	Cooling mode (factory setting)	1 K
	Setpoint setting range	
	☀ Normal operation	5...40 °C
	☾ Economy (Energy saving) (only with RDF110)	OFF, 5...40 °C
	⏸ Protection (Standby)	OFF, 5...40 °C
	Factory setting of setpoints	
	☀ Normal operation	20 °C
	☾ Economy (Energy saving) in heating / cooling mode	16 °C / 28 °C
⏸ Protection (Standby) (heating and cooling mode)	OFF	
Built-in room temperature sensor		
Measuring range	0...49 °C	
Accuracy at 25 °C	< ± 0.5 K	
Temperature calibration range	± 3.0 K	
Resolution of settings and display		
Setpoints	0.5 °C	
Current temperature value displayed	0.5 °C	
Environmental conditions	Operation	
	Climatic conditions	to IEC 60721-3-3 class 3K5
	Temperature	0...+50 °C
	Humidity	<95 % r.h.
	Transport	
	Climatic conditions	to IEC 60721-3-2 class 2K3
	Temperature	-25...+60 °C
	Humidity	<95 % r.h.
	Mechanical conditions	class 2M2
	Storage	
Climatic conditions	to IEC 60721-3-1 class 1K3	
Temperature	-25...+60 °C	
Humidity	<95 % r.h.	
Norms and standards	EU Conformity (CE)	CE1T3057xx ^{*)}
	RCM Conformity	CE1T3057en_C1 ^{*)}
	Devices of safety class	II to EN 60730-1
	Pollution class	normal
	Degree of protection of housing	IP 30 to EN 60 529
General	Connection terminals	solid wires or prepared stranded wires 2 x 0.4-1.5 mm ² or 1 x 2.5 mm ²
	Weight	0.28 kg
	Color of housing front	white, NCS S 0502-G (RAL 9003)

*) The documents can be downloaded from <http://siemens.com/bt/download>.

Connection terminals

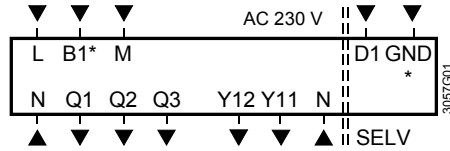

L, N Operating voltage AC 230 V
 B1* Changeover (QAH11.1+ ARG86.3) or external room temperature sensor (QAH11.1 / QAA32)
 M Measuring neutral for sensor

D1, GND* Status input for potential-free operating mode changeover switch
 Q1 Control output "Fan speed 1 AC 230 V"
 Q2 Control output "Fan speed 2 AC 230 V"
 Q3 Control output "Fan speed 3 AC 230 V"
 Y11 Control output "Valve" AC 230 V (N.O., for normally closed valves) or output for compressor
 Y12 Control output "Valve" AC 230 V (N.C., for normally open valves)

* Only with RDF110 or RDF110/IR

Connection diagrams

Application:

2-pipe fan coil units

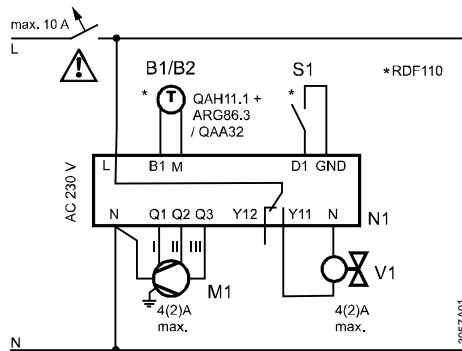

B1* Return air temperature sensor (QAH11.1) or external room temperature sensor (QAA32)
 B2* Changeover sensor (temperature sensor QAH11.1 + changeover mounting kit ARG86.3)
 M1 3-speed fan
 N1 Room temperature controller RDF110..
 S1* External operating mode changeover switch
 V1 Zone valve

* Only with RDF110 or RDF110/IR

Application:

Compressor in DX type equipment

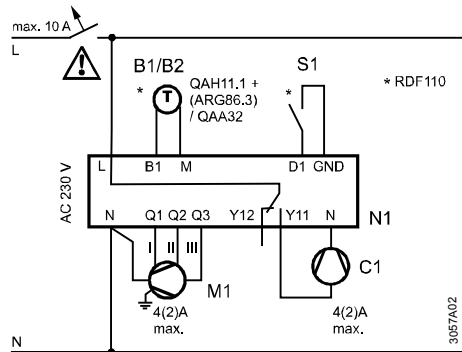

B1* Return air temperature sensor (QAH11.1) or external room temperature sensor (QAA32)
 B2* Changeover sensor (temperature sensor QAH11.1 + changeover mounting kit ARG86.3)
 M1 3-speed fan
 N1 Room temperature controller RDF110..
 S1* External operating mode changeover switch
 C1 Compressor

* Only with RDF110 or RDF110/IR

Note: For compressor application, RDF110 or RDF110/IR is recommended

Dimensions

Controller

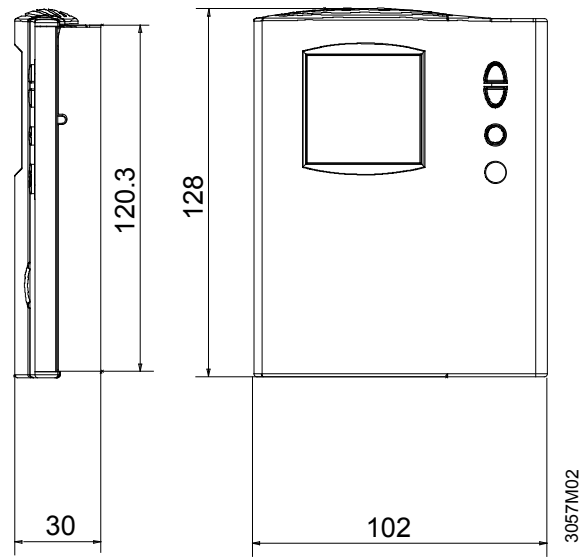

Mounting base

