

## OpenAir™

### GEB Series Non-spring Return, 24 Vac, 132 lb-in Rotary Electronic Damper Actuators



#### Description

The OpenAir direct-coupled, 24 Vac, non-spring return electronic actuator is designed for modulating and floating control of building HVAC dampers.

#### Features

- Brushless motor technology with stall protection
- Unique self-centering shaft coupling
- Manual override
- 132 lb-in (15 Nm) torque
- 5° preload as shipped from factory
- Mechanical range adjustment capabilities
- Offset and span adjustment models available
- Models with independently adjustable, dual auxiliary switches available
- Built-in 1/2-inch conduit connection
- UL and cUL listed, CE certified

#### Application

Used in constant or variable air volume installations for the control of HVAC dampers requiring up to 132 lb-in (15 Nm) torque.

#### Warning/Caution Notations

<b>WARNING:</b>		Personal injury/loss of life may occur if you do not follow a procedure as specified.
<b>CAUTION:</b>		Equipment damage may occur if you do not follow a procedure as specified.

## Product Numbers

Table 1.

Product Number	Operating Voltage	Control		Cable		Built-in Control Options			
	24 Vac $\pm 20\%$	Modulating (0 to 10 Vdc)	Floating	Plenum	Standard	Position Feedback	Dual Auxiliary Switches	Offset and Span	Input Signal Selectable 0 – 10 Vdc or 2-10 Vdc
GEB131.1P	•	-	•	•	-	-	-	-	-
GEB131.1U	•	-	•	-	•	-	-	-	-
GEB132.1U	•	-	•	-	•	•	-	-	-
GEB136.1U	•	-	•	-	•	-	•	-	-
GEB161.1P	•	•	-	•	-	•	-	-	•
GEB161.1U	•	•	-	-	•	•	-	-	•
GEB164.1U	•	•	-	-	•	•	•	•	-

## Specifications

Power Supply 24 Vac	Operating voltage	24 Vac $\pm 20\%$
	Frequency	50/60 Hz
	Power consumption	
	Running:	
	GEB16x GEB13x	5 VA/4W 3 VA/3W
	Holding:	
	GEB 16x	1 VA/1W
	Equipment rating	Class 2, in accordance with UL/CSA Class III per EN 60730
Control Signal	Input signal (wires 8-2) GEB16x	
	Voltage-input	0 to 10 Vdc (max. 35 Vdc)
	Input resistance	>100K ohms
Feedback signal	Position output signal (wires 9-2) GEB16x	
	Voltage-output	0 to 10 Vdc
	Maximum output current	$\pm 1$ mA
Function	Running torque	132 lb-in (15 Nm)
	Maximum torque	265 lb-in (30 Nm)
	Runtime for 90° opening or closing	
	60 Hz	125 seconds
	50 Hz	150 seconds
	Nominal angle of rotation	90°
	Maximum angular rotation	95°

Mounting	Shaft size	1/4 to 3/4-inch (6.4 to 20.5 mm) dia. 1/4 to 1/2-inch (6.4 to 13 mm) square
	Minimum shaft length	3/4-inch (20 mm)
Housing	Enclosure	NEMA 1 IP54 according to EN 60 529
	Material	Die cast aluminum alloy
	Gear lubrication	Silicone free
Ambient conditions	Ambient temperature Operation	-25°F to 130°F (-32°C to 55°C)
	Storage and transport	-40°F to 158°F (-40°C to 70°C)
	Ambient humidity (non-condensing)	95% rh
Agency certification		UL60730 (to replace UL873) cUL certified to Canadian Standard C22.2 No. 24-93
CE Conformity	Low voltage directive	2006/95/EC
	Product safety: Automatic electrical controls for household and similar use	EN 60 730-2-14 (Type 1)
	Electromagnetic compatibility (EMC) Immunity for all models, except GEB132.xx Immunity for GEB132.xx Emissions for all models	2004/108/EC EN61000-6-2 EN61000-6-1 EN61000-6-3
Auxiliary features		
	<b>Control signal adjustment</b>	
	Offset (start point)	Between 0 to 5V
	Span	Between 2 to 30V
	<b>Dual auxiliary switches</b>	
	AC rating	24 to 250 Vac AC 6A resistive, AC 2A general purpose
	DC rating	12 to 30 Vdc DC 2A
	Switch Range	
	Switch A	0 to 90° with 5° intervals
	Recommended range usage	0 to 45°
	Factory setting	5°
	Switch B	0 to 90° with 5° intervals
	Recommended range usage	45 to 90°
	Factory setting	85°
	Switching hysteresis	2°
	<b>Feedback potentiometer</b> (GEB 132.1U)	0 to 1000 ohm <10 mA
	Voltage	UL-Class 2 (SELV/PELV for CE)

Auxiliary features,  
 Continued

**WARNING:**



Apply only AC line voltage or only UL-Class 2 voltage (SELV for CE conformance) to the switching outputs of both auxiliary switches A and B. Mixed operation is not permissible. See Wiring for details.

**NOTE:** With plenum cables, only UL-Class 2 (SELV for CE) is permitted).

Miscellaneous	Pre-cabled connection	18 AWG
	Cable length	3 feet (0.9m) length
	Life cycle	Designed for over 50,000 full strokes at rated torque and temperature
	Dimensions: Inches (mm)	8-3/8 H × 3-1/4 W × 2-2/3 D (212 H × 83 W × 68 D)
	Weight	2.2 lbs. (1 kg)
	Country of Origin	USA

**Actuator Components**

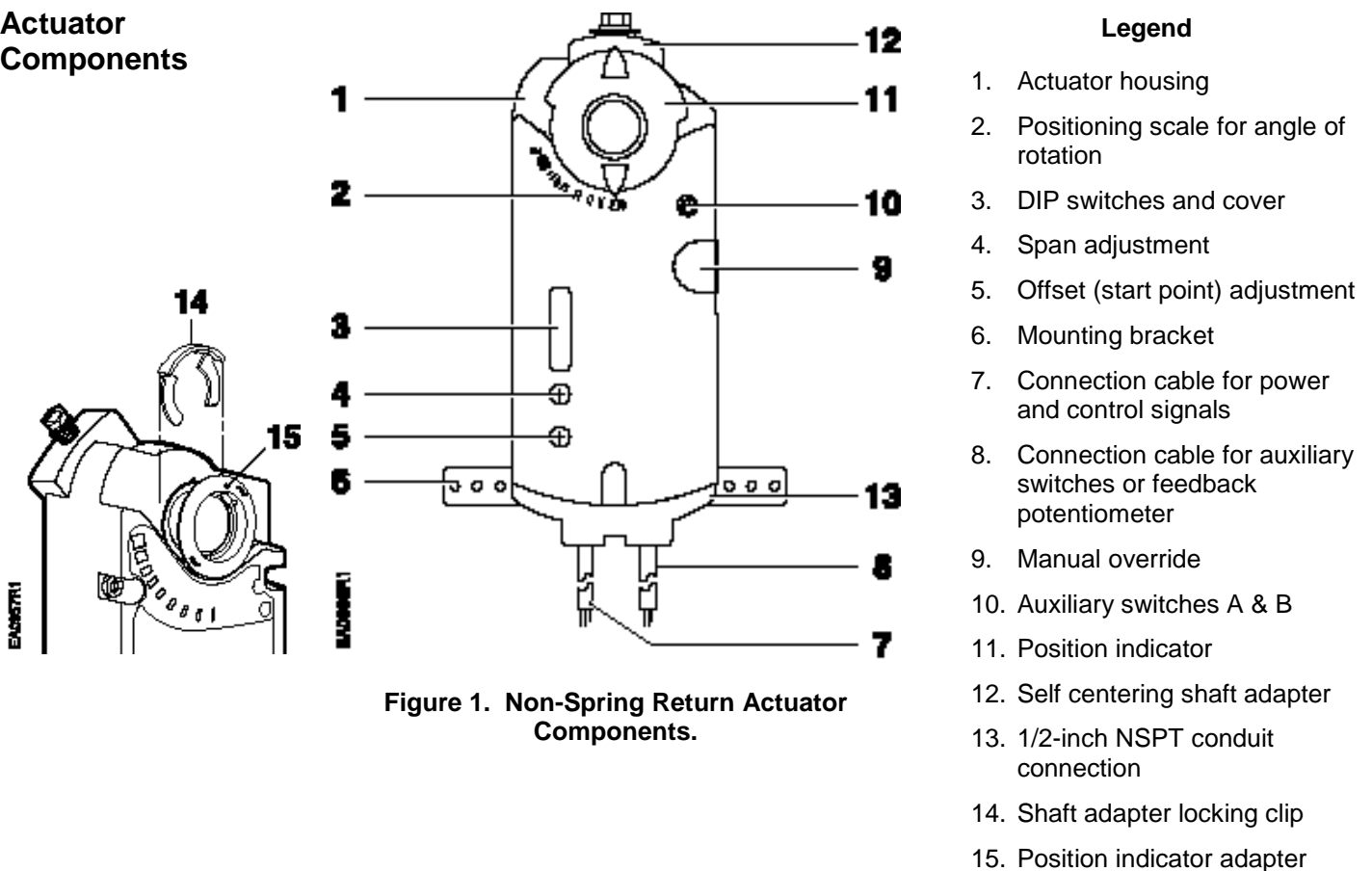

**Figure 1. Non-Spring Return Actuator Components.**

**Accessories**

**NOTE:** The auxiliary switches, control signal adjustment, and feedback potentiometer cannot be added in the field. Order the product number that includes the option(s).

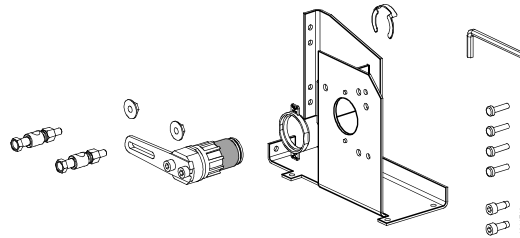

**Figure 2. Floor /Frame Mount Kit.**

**ASK71.11:** For in-the-air-stream applications: Anywhere a foot-mounted actuator can be mounted. Can also be directly mounted to a damper frame with louvers and vents and in applications where use of the floor mount is not possible. Kit contains:

- Crank arm to change the angular rotation into a linear stroke.
- Support bearing ring to minimize side loading on the actuator's output bearing.
- Mounting bracket.
- Required mounting fasteners.

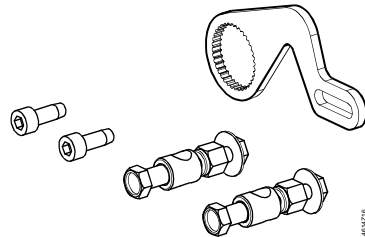

**Figure 3. Rotary to Linear Crank Arm Kit.**

**ASK71.13:** Allows a direct-coupled actuator to provide an auxiliary linear drive. Can be used to simultaneously drive a set of opposing or adjacent dampers with a single actuator. Kit contains:

- Crank arm to attach to the splined hub of the shaft adapter.
- Mounting fasteners.

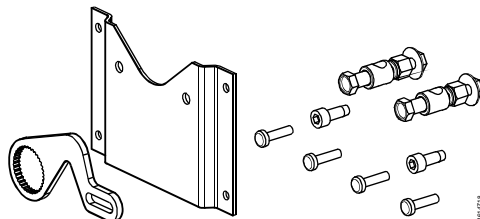

**Figure 4. Rotary to Linear Crank Arm Kit with Mounting Bracket.**

**ASK71.14:** Allows economical mounting of an OpenAir actuator to a variety of surfaces. Should be used in applications where the actuator can be rigid-surface mounted and a linear stroke output is required. Kit contains:

- Crank arm to attach to the splined hub of the shaft adapter.
- Mounting bracket.
- Required mounting fasteners.

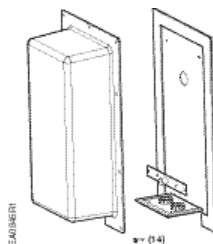

**Figure 5. NEMA 3R Weather Shield.**

**ASK75.3U:** GEB actuators are UL listed to meet NEMA 3R requirements (a degree of protection against rain, sleet, snow, and damage from external ice formation) when installed with ASK75.3U Weather Shield and outdoor-rated conduit fittings in the vertical position.

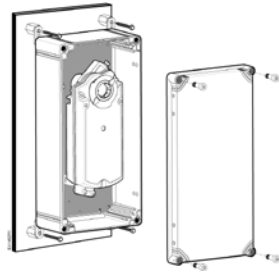
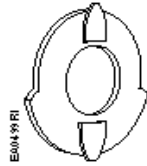

**Figure 6. NEMA Type 4X Weather Shield.**

**ASK75.7U:** GEB Actuators are UL listed to meet NEMA Type 4X requirements (a degree of protection against falling dirt, rain, sleet, snow, windblown dust, splashing water, hose-directed water, corrosion, and damage from external ice formation) when installed with an ASK75.7U Weather Shield and outdoor-rated conduit fittings. This weather shield may be mounted in any orientation.

For dimensions, see Figure 19.

## Service Parts



**985-094P10**

Position indicators (10/pkg.)



**985-093**

Standard shaft adapter



**985-098**

Adjustment Tool

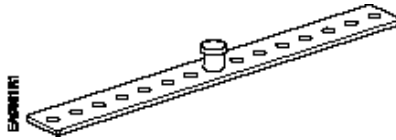

**985-092**

Anti-rotation (mounting) bracket.

**Figure 7. Miscellaneous Service Parts.**

## Operation

### GEB16x

Apply a 0 to 10 Vdc control signal between wire 8 (Y) and wire 2 (G0) to operate the damper actuator. The angle of rotation is proportional to the control signal. A 0 to 10 Vdc position feedback output signal is available between wire 9 (U) and wire 2 (G0) to monitor the position of the damper motor.

In the event of a power failure, the actuator holds its position. In the event that only the control signal is lost, the actuator returns to the "0" position.

### GEB13x

A floating control signal controls the damper actuator. The actuator's angle of rotation is proportional to the length of time the signal is applied. A 24 Vac control signal to wire 6 (Y1) causes the actuator coupling to rotate clockwise. A 24 Vac control signal to wire 7 (Y2) causes the actuator coupling to rotate counterclockwise.

To reverse the direction of rotation, wires 6 (Y1) and 7 (Y2) can be interchanged.

With no control voltage, the damper actuator holds its position.

## Overload protection

In the event of a blockage in the damper, the actuator is overload protected over the full range to prevent damage to the actuator.

## Life expectancy

An improperly tuned loop will cause excessive repositioning that will shorten the life of the actuator.

## Sizing

The type of actuator required depends on several factors:

1. Obtain damper torque ratings (ft-lb/ft<sup>2</sup> or Nm/m<sup>2</sup>) from the damper manufacturer.
2. Determine the area of the damper.
3. Calculate the total torque required to move the damper:

$$\text{Total Torque} = \frac{\text{Torque Rating} \times \text{Damper Area}}{\text{SF}^1}$$

<sup>1</sup> Safety Factor: When calculating the total torque required, a safety factor should be included for unaccountable variables such as slight misalignments, aging of the damper, etc. A suggested safety factor is 0.80.

4. Select the non-spring return actuator type using Table 2.

**Table 2.**

Total Torque		Actuator
<44lb-in	(5Nm)	GDE
>44lb-in <88lb-in	(>5Nm <10Nm)	GLB
>88lb-in <132lb-in	(>10Nm <15Nm)	GEB
>132lb-in <177lb-in	(>15Nm <20 Nm)	GBB
>177lb-in <310lb-in	(>20Nm <35Nm)	GIB
>310lb-in <620lb-in	(>35Nm <70Nm)	Use tandem-mounting bracket ASK73.2U with any combination of GIB161 AND GIB166 actuators or use Master/Slave Actuators. See <i>OpenAir™ Electronic Damper Actuators Technical Instructions</i> (155-542P25).

## Mounting and Installation

- Place the actuator on the damper shaft so that the front of the actuator is accessible. (The label and the manual override button are on the front side.)
- The minimum damper drive shaft is 3/4-inches (20mm). The shaft length determines whether the shaft adapter will be mounted on the front or back of the actuator.
- Refer to Specifications for minimum and maximum damper shaft dimensions.
- Set auxiliary switches, DIP switches, and Offset/Span as required by your application. (See following sections for details.)
- The position indicator can be mounted to show either the clockwise or counterclockwise 0 to 90 scale.
- A mounting bracket is included with the actuator.
- The shaft adapter and mounting parts are shipped in a separate container with the actuator.
- The actuator is shipped from the factory with a 5° pre-load to ensure tight damper close off.
- Detailed mounting instructions are included with each actuator.

## Manual Override

To move the damper blades and lock the position without power present:

1. Hold down the **PUSH** button.
2. Make adjustments to the damper position.
3. Release the **PUSH** button.

Once power is restored, the actuator returns to automated control.

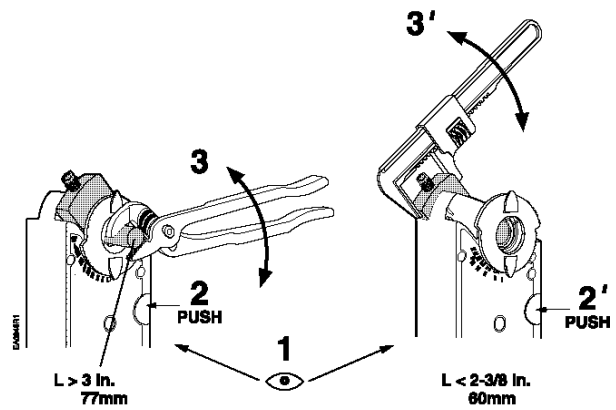

Figure 8. Manual Override.

## Mechanical Range Adjustment

The angular rotation is adjustable between 0 and 90° at 5-degree intervals. The range of shaft movement is limited by mounting the shaft adapter:

1. Loosen the shaft adapter from the damper shaft and remove the actuator from the damper shaft.
2. Remove the clip and shaft adapter from the actuator.

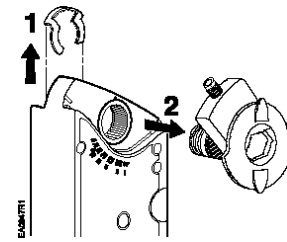

Figure 9.

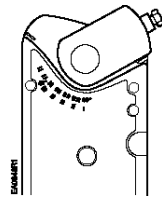

Figure 10.

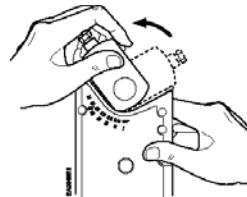

Figure 11

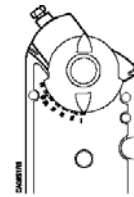

Figure 12.

3. Return the actuator gear train to the “0” position using the steps that follow for the clockwise or counterclockwise damper shaft rotation.

### Clockwise to open:

- a. Insert the shaft adapter to the right as close as possible to the raised stop. See Figure 10.
- b. Hold down the **PUSH** button and rotate the shaft adapter to the left until it stops. See Figure 11.
- c. Release the **PUSH** button.
- d. If the shaft adapter is not resting against the left raised stop, remove the adapter and insert it against the left stop.
- e. Place the position indicator to the “0” position on the outside scale. See Figure 12.

### Counterclockwise to open:

- a. Insert the shaft adapter to the left as close as possible to the raised stop.
- b. Hold down the **PUSH** button and rotate the shaft adapter to the right until it stops.
- c. Release the **PUSH** button.
- d. If the shaft adapter is not resting against the right raised stop, remove the adapter and insert it against the right stop.
- e. Place the position indicator to “0” on the inside scale.



4. Determine the angle of rotation for the damper blade shaft. Subtract that amount from 90°.
5. Remove the shaft adapter and insert it with the position indicator pointing to the mark on the scale calculated in the previous step. See Figure 12.
6. Attach the clip.
7. Rotate the damper blade shaft to its "0" position.
8. Return the actuator to the damper shaft and tighten the shaft adapter to the damper shaft.

**Control signal adjustment**

GEB164.1U  
 (Offset and Span)

The offset (start point) and span of the control signal can be adjusted. The offset,  $U_0$ , can be adjusted between 0 to 5 Vdc. The span,  $\Delta U$ , can be adjusted between 2 to 30 Vdc.

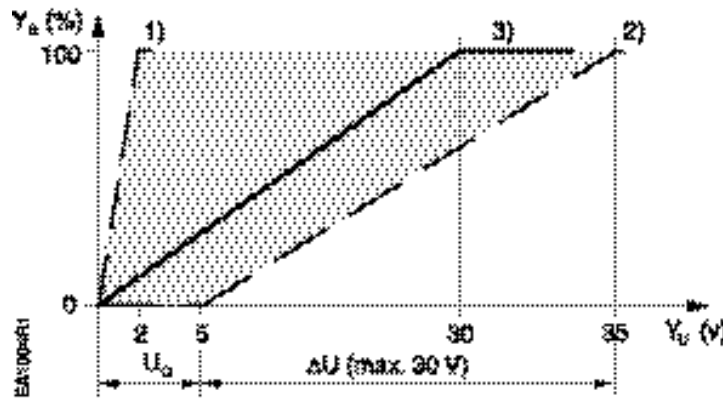

- $Y_s$  Mechanical positioning range (100% = angle of rotation 90°)
- $Y_u$  Control signal
- $U_0$  Offset (start point)
- $\Delta U$  Span

Factory setting:  
 30V span  
 0 offset

**NOTE:** When the mechanical limitation of the angle of rotation and self-adaptive function are ON, 100% does not equal 90°.

1.  $U_0 = 0V, \Delta U = 2V$ : The minimum working range for  $Y_s = 100\%$
2.  $U_0 = 5V, \Delta U = 30V$ : The maximum working range for  $Y_s = 100\%$
3.  $U_0 = 0V, \Delta U = 30V$ : Factory setting

**Figure 13. The Minimum and Maximum Control Signal Adjustment.**

**Example:**

Open the actuator from 0 to 50% (45°) using a control signal of:

$$U_{min} = 2V \text{ to } U_{max} = 10V.$$

**Calculating the valve of  $\Delta U$ :**

$$\Delta U = \frac{100 [\%] (U_{max} - U_{min})}{\text{Working angle of rotation in } \%} = \frac{100 \times (10 - 2)}{50} = 16V$$

**Control Signal Adjustment, Continued**

$U_0 = 2; \Delta U = 16V$

$U_{min}$  = minimum control signal  
 $U_{max}$  = maximum control signal

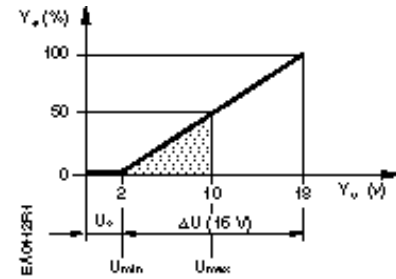

**Figure 14. Example.**

**Dual auxiliary switch**

**GEB164.1U,**  
**GEB136.1U**

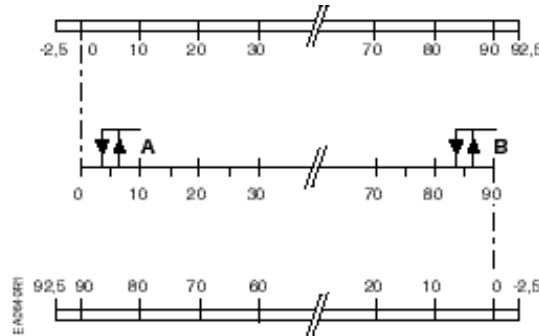

← Actuator scale: Clockwise

Adjustment range for switches A and B:  
 Setting interval: 5°  
 Switching hysteresis: 2°

← Actuator Scale: counterclockwise

To change the settings of A and B:

**NOTE:** The scale is only valid when the actuator is in the "0" position on clockwise motion.

- Use the adjustment tool provided with the actuator to turn the switch adjustment dials to the desired signal setting.

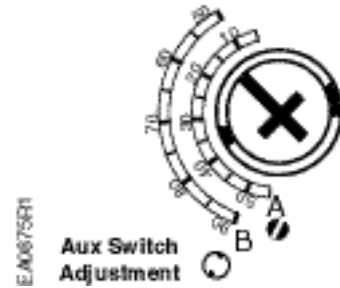

**Figure 15. Dual Auxiliary Switch Dials.**

Factory setting:  
 Switch A 5°  
 Switch B 85°

**NOTE:** Use the long arm of the "+" to point to the position of switch A. Use the narrower tab on the red ring to point to the position of switch B.

**DIP Switch Functionality**

**GEB161**  
**GEB164**

Description	Label	Description	Function
Counterclockwise		Clockwise	Rotary angle direction
Active		0	Self-adaptation to mechanical range
2-10 Vdc	2-10	0-10	<b>GEB161:</b> Positioning control signal 2-10 or 0-10
Offset 0-5V Span 2-30V	ADJ	0-10	<b>GEB164:</b> Positioning signal. Turn on or off capability to adjust offset/span.

**Figure 16. DIP Switches.**

**DIP Switch  
 Functionality,  
 Continued**

**Rotary direction**



- The arrow direction must match the rotational direction of the actuator.
- Factory setting:

**Self-adapting**

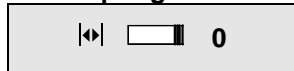

- Alternative switch-on/off for self-adaptation.  
 ||: ON  
 0: OFF
- Factory setting: 0

**CAUTION:**



When turning the self-adaptive feature on, or after a software reset with the feature on, the actuator will enter a five-minute calibration cycle as the actuator adjusts to the rotation limits of the system.

A software reset happens after power on, or may be caused by electrostatic discharge (ESD) at levels of 2kV and above.

**Positioning Control Signal: (GEB161)**



- Alternative settings:  
 2-10 Vdc  
 0-10 Vdc
- Factory setting: 0-10 Vdc

**Positioning Control Signal: (GEB164)**



- Alternative settings:  
 ADJ: Allows offset/span adjustment capability  
 0-10V: Ignores offset/span capability and provides 0-10 Vdc input signal only
- Factory setting: ADJ

**Wiring**

All wiring must conform to NEC and local codes and regulations. Use earth ground isolating step-down Class 2 transformers. Do not use autotransformers.

The maximum rating for a Class 2 step-down transformer is 100 VA. Determine the supply transformer rating by summing the VA ratings of all actuators and all other components used. It is recommended that one transformer power no more than 10 actuators (or 80% of its VA).



**WARNING:**

Mixed switch operation is not permitted to the switching outputs of both auxiliary switches (A and B).

Either all six outputs of the dual auxiliary switches must be connected to the AC line voltage, or all six outputs must be connected to UL-Class 2 voltage (SELV for CE conformance).

**NOTE:** With Plenum cables only UL-Class 2 voltage (SELV for CE conformance) is permitted.



**WARNINGS:**

Installations requiring **CE** Conformance:

- Except for the auxiliary switches (See *Warning* above) all wiring for actuators must be safety extra-low voltage (SELV) or protective extra-low voltage (PELV) per HD384.
- Use safety transformers per EN61558 with double isolation, designed for 100% duty-cycle for supplying SELV or PELV circuits.
- Over-current protection for supply lines is maximum 10A.



**CAUTION:**

Do not parallel GEB13x actuators with any other type of actuator.

**Wire Designations**

Each wire has the standard symbol printed on it. See Table 3.

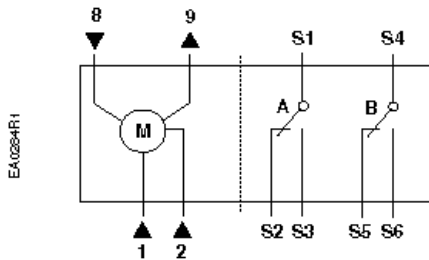

**Figure 17. Modulating 0 to 10 Vdc Control.**  
 24 Vac Power Supply.

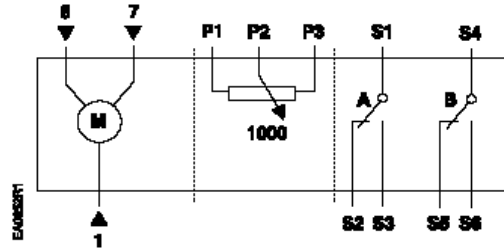

**Figure 18. Floating Control.**  
 24 Vac Power Supply.

**Table 3.**

Actuators	Symbol	Function	Terminal Designations	Color
<b>24 Vac Power Supply</b>	1	Supply (SP)	G	Red
	2	Neutral (SN)	G0	Black
	6	Control signal clockwise	Y1	Violet
	7	Control signal counterclockwise	Y2	Orange
	8	0 to 10 Vdc input signal	Y	Gray
	9	Output for 0 to 10 Vdc position indication	U	Pink
<b>Auxiliary Switches</b>	S1	Switch A Common	Q11	Gray/red
	S2	Switch A N.C.	Q12	Gray/blue
	S3	Switch A N.O.	Q14	Gray/pink
	S4	Switch B Common	Q21	Black/red
	S5	Switch B N.C.	Q22	Black/blue
	S6	Switch B N.O.	Q24	Black/pink
<b>Potentiometer</b>	P1	Feedback Potentiometer 0 to 100% P1 - P2	a	White/red
	P2	Feedback Potentiometer Common	b	White/blue
	P3	Feedback Potentiometer 100 to 0% P3 - P2	c	White/pink

---

**Start-Up/  
Commissioning****Non-spring Return  
Modulating Control  
(0-10 Vdc)  
24 Vac**

1. Check Operation:
    - a. Connect wires 1 (red) and 2 (black) to the 24 Vac power supply.
    - b. Set the Digital Multimeter (DMM) dial to Vdc for the actuator input signal.
    - c. Connect wires 2 (black) and 8 (gray) to a Digital Multimeter (DMM).
    - d. Apply a full-scale input signal (10 Vdc) to wire 8 (gray).
    - e. Allow the actuator shaft coupling to rotate from 0 to 90°.
    - f. Stop the signal to wire 8 (gray).  
The shaft coupling returns to the "0" position.

---

  2. Check Feedback:
    - a. Set the DMM dial to Vdc.
    - b. Attach wires 2 (black) and 9 (pink) to the DMM.
    - c. Apply a full-scale input signal to wire 8 (gray).  
The reading at the DMM should increase.
    - d. Remove the signal from wire 8 (gray).  
The reading at the DMM should decrease and the actuator shaft coupling returns to the "0" position.

---

  3. Check the Auxiliary Switch A:
    - a. Set the DMM dial to ohms (resistance) or continuity check.
    - b. Connect wires S1 and S3 to the DMM.  
The DMM should indicate open circuit or no resistance.
    - c. Apply a full-scale input signal to wire 8 (gray).  
The DMM should indicate contact closure as the actuator shaft coupling reaches the setting of switch A.
    - d. Connect wires S1 and S2 to the DMM.  
The DMM should indicate open circuit or no resistance.
    - e. Stop the signal to wire 8 (gray).  
The DMM should indicate contact closure as the actuator shaft coupling reaches the setting of switch A.

---

  4. Check the Auxiliary Switch B:
    - a. Set the DMM dial to ohms (resistance) or continuity check.
    - b. Connect wires S4 and S6 to the DMM.  
The DMM should indicate open circuit or no resistance.
    - c. Apply a full-scale input signal to wire 8 (gray).  
The DMM should indicate contact closure as the actuator shaft coupling reaches the setting of switch B.
    - d. Connect wires S4 and S5 to the DMM.  
The DMM should indicate open circuit or no resistance.
    - e. Stop the signal to wire 8 (gray).  
The DMM should indicate contact closure as the actuator shaft coupling reaches the setting of switch B.
-

---

**Non-spring Return  
Floating  
24 Vac**

1. Check Operation:
    - a. Apply a control signal (24 Vac) to wires 1 (red) and 6 (violet).
    - b. Allow the actuator shaft coupling to rotate from 0 to 90°.
    - c. Stop applying a control signal to wires 1 (red) and 6 (violet).
    - d. Apply a control signal (24 Vac) to wires 1 (red) and 7 (orange).
    - e. Allow the actuator shaft coupling to rotate from 90° to 0°.

---

  2. Check Feedback:
    - a. Set the DMM dial to ohms.
    - b. Connect wires P1 and P2 to the DMM.  
The DMM should indicate a resistive value.
    - c. Apply a control signal (24 Vac) to wires 1 (red) and 6 (violet).  
The reading of the DMM should increase.
    - d. Stop applying a control signal to wires 1 (red) and 6 (violet).
    - e. Connect wires P2 and P3 to the DMM. The DMM should indicate a resistive value.
    - f. Apply a control signal (24 Vac) to wires 1 (red) and 7 (orange).  
The reading of the DMM should increase.

---

  3. Check the Auxiliary Switch A:
    - a. Set the DMM dial to ohms (resistance) or continuity check.
    - b. Connect wires S1 and S3 to the DMM.  
The DMM should indicate an open circuit or no resistance.
    - c. Apply a control signal (24 Vac) to wires 1 (red) and 6 (violet).  
The DMM should indicate contact closure as the actuator shaft coupling reaches the setting of switch A.
    - d. Stop applying a control signal to wires 1 (red) and 6 (violet).
    - e. Connect wires S1 and S2 to the DMM.  
The DMM should indicate an open circuit or no resistance.
    - f. Apply a control signal (24 Vac) to wires 1 (red) and 7 (orange).  
The DMM should indicate contact closure as the actuator shaft coupling reaches the setting of switch A.

---

  4. Check the Auxiliary Switch B:
    - a. Set the DMM dial to ohms (resistance) or continuity check.
    - b. Connect wires S4 and S6 to the DMM.  
The DMM should indicate an open circuit or no resistance.
    - c. Apply a control signal to wires 1 (red) and 6 (violet).  
The DMM should indicate contact closure as the actuator shaft coupling reaches the setting of switch B.
    - d. Stop applying a control signal to wires 1 (red) and 6 (violet).
    - e. Connect wires S4 and S5 to the DMM.  
The DMM should indicate an open circuit or no resistance.
    - f. Apply a control signal (24 Vac) to wires 1 (red) and 7 (orange).  
DMM should indicate contact closure as the actuator shaft coupling reaches setting for switch B.
-

**Service**



**WARNING:**

Do not open the actuator.  
 If the actuator is inoperative, replace the unit.

**Troubleshooting**



**WARNING:**

To avoid injury or loss of life, pay attention to any hazardous voltage (Example: 120 Vac) when performing checks.

- Check that the wires are connected correctly.
- Check that auxiliary switches, DIP-switches, and Offset/Span are set correctly.
- Set the DMM dial to Vac and verify that the operating voltage is within range.
- If the actuator is not working, check the damper for blockage. If blocked, remove the obstacle and cycle the actuator power off and on. The actuator should resume normal operating mode.

**Dimensions**

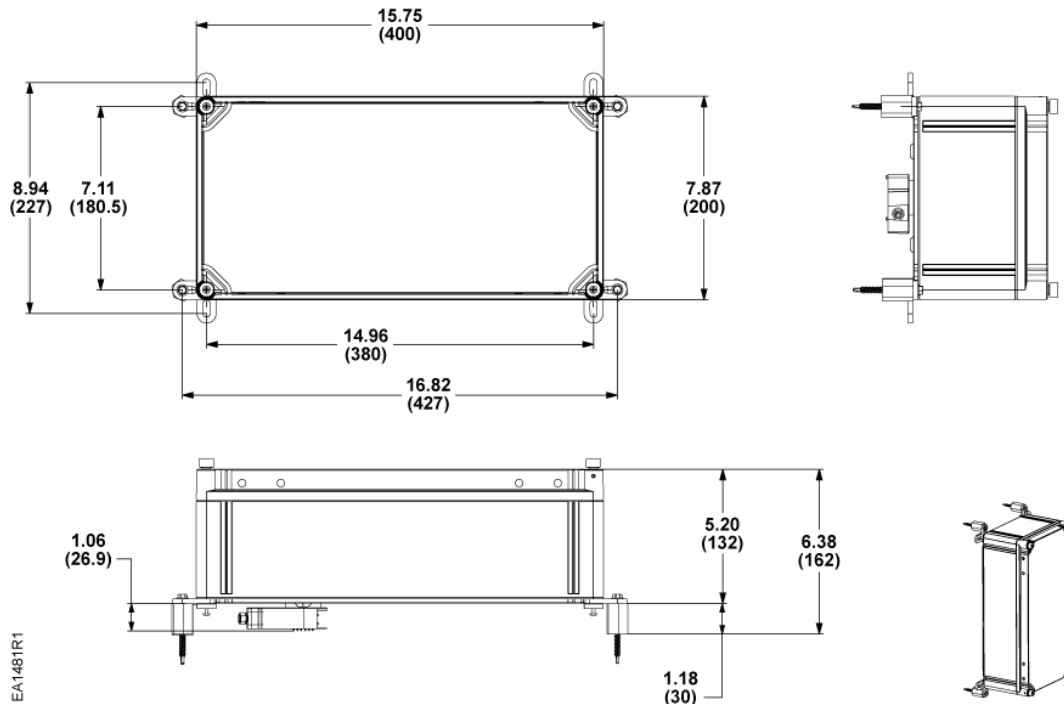

**Figure 19. Dimensions of the ASK75.7U Weather Shield in Inches (Millimeters).**

## Dimensions

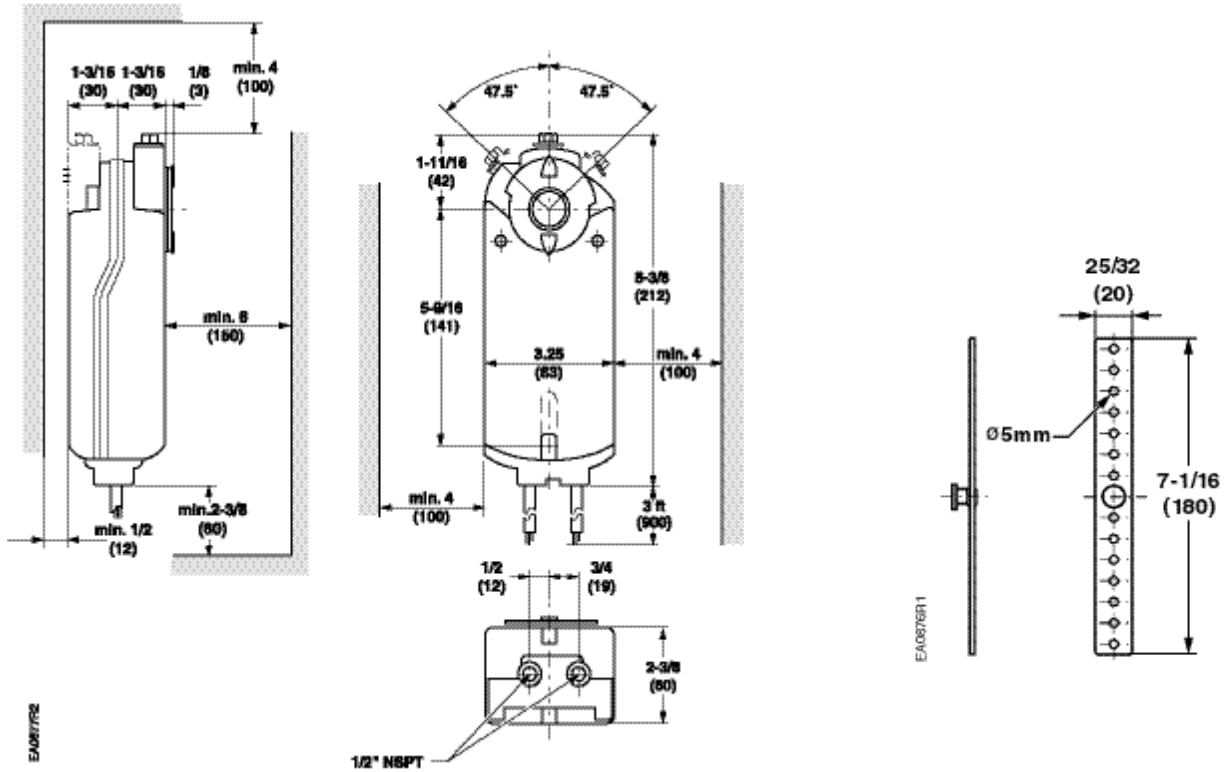

Figure 20. Dimensions of the GEB Actuator and Mounting Bracket in inches (mm).

Information in this publication is based on current specifications. The company reserves the right to make changes in specifications and models as design improvements are introduced. OpenAir is a trademark of Siemens Schweiz AG. Other product or company names mentioned herein may be the trademarks of their respective owners. © 2014 Siemens Industry, Inc.