



Synco™ 700



Switching and Monitoring Device

RMS705

- Freely configurable unit thanks to extended configuration choices
- Additional universal inputs for indication and monitoring /alarming
- Data acquisition: Pulse counter (for display only), hours run counter, data trending, event logger (e.g. for the legionella function)
- Choice of switching and monitoring functions in combination with logic operations
- Lead / lag control of pumps, fans, motors, refrigeration machines, etc., with automatic changeover
- 3 basic universal controllers
- Unit can be extended with extension modules type RMZ785 and RMZ787
- Menu-driven operation with separate plug-in type or detached operator unit
- Konnex bus connection facility for operation and process information

Use

- Switching and monitoring of plant components in heating, ventilation or refrigeration plant
- For non-standard applications

The RMS705 offers extended configuration choices to allow free configurations within the scope of the available function blocks and, for this reason, does not provide any predefined standard applications.

As with all types of Synco™ 700 devices, once an application is created, it can be archived in the form of readable parameter sets to be reused as an adapted or identical application for other plant.

Functions

Universal inputs

8 to 28 ^{*)} universal inputs for:

- Passive or active analog input signals of various measuring variables (°C, %, g/kg, kJ/kg, W/m², bar, mbar, m/s, Pa, ppm, BTU, without unit, pulse)
- Digital input signals (potential-free contacts)

*) When using extension modules: 1 x RMZ787 + 2 x RMZ785

Additional I/Os via extension modules

Additional inputs and outputs can be provided for extending the unit's functionality.

A **maximum of 3 extension modules per RMS705** can be connected. Suited are the following types of modules:

- Maximum 2 universal modules type RMZ785 (8 UI)
- Maximum 2 universal modules type RMZ787 (4 UI, 4 DO)

As a maximum, each RMS705 has:

- 28 universal inputs (Ni1000, Pt1000, T1, DC 0...10 V, 0...1000 Ω, digital, pulses)
- 14 control output relays
- 4 modulating outputs DC 0...10 V

Data acquisition

Pulse counter (for display only, not for billing purposes)

4 counters are available for acquiring consumption values.

Pulses from gas, hot water, cold water and electricity meters can be handled.

- Pulse counting (Wh, kWh, MWh, kJ, MJ, GJ, ml, l, m³, heat cost units, BTU, without unit)

Hours run meters

There are 4 hours run meters showing:

- The total number of operating hours
- Maintenance messages (with adjustable interval)
- The number of operating hours since the last maintenance visit

Trend display of data

4 independent trend channels are available for recording measuring variables.

In addition to the local inputs of the unit, it is also possible to log room temperatures and the outside temperature delivered via the KNX bus.

Event logger (e.g. for the legionella function)

4 event loggers are available; they are used for recording events and for monitoring their scheduled occurrence.

- Logging the last 10 events per logger with time of day and date stamp when "Limit value on" and "Limit value off" are reached
- Saving the maximum or minimum value during the period of time the event occurs
- Selectable fault status message when the minimum or maximum
 - event cycle time is crossed
 - event duration is exceeded

Switching and monitoring functions

Fault status block

A fault status block is available featuring:

- 20 fault status inputs, configurable via universal inputs (analog and digital) and fault status messages delivered via the KNX bus
- Fault indication with red LED, acknowledgement via button
- 2 relay outputs, configurable as fault relays
- 1 digital input, for the external reset of fault status messages

7-day time switches

Six 7-day time switches provide the following functions:

- 6 switch-on or switch-off times per day, configurable relay output
- Yearly time switch with automatic summer- / wintertime changeover
- Operation selector (AUTO, ON, OFF), can be configured for manual control
- Configurable holiday and special day program
- From other 7-day time switches via the KNX bus as slaves (sending not possible)

Logic function blocks

10 freely configurable logic function blocks are available; they are used for handling several logically connected universal input variables.

- Configurable AND, NAND, OR, NOR, EXOR and EXNOR logic functions
- Adjustable switch-on and switch-off delays
- Adjustable minimum on and off times
- Operation selector (AUTO, ON, OFF), configurable for manual control

Comparators

2 comparators are available; they are used for comparing 2 analog input signals.

Output signal with adjustable switch-on and switch-off delays and adjustable minimum on and off times.

Universal motor blocks

6 universal motor blocks are available; they are used for controlling and monitoring motors:

- 1-speed motors (pumps, fans)
- 2-speed motors (fans)
- Twin motors (twin pumps)
- Precommand for dampers or valves installed upstream
- Adjustable times
- Motor kick and switching on at low outside temperatures
- Hours run counter per motor block

Rotary step switches

2 rotary step switches are available affording selectable step switch characteristics per block:

- Linear step switch
- Binary step switch
- Flexible step switch
- With stepwise precommand, switching and modulating outputs
- Lead / lag control of pumps, fans, motors, refrigeration machines, etc., with automatic changeover
- Adjustable times

Control functions

Universal controllers

There are 3 universal controllers as PID sequence controllers each with 2 sequence outputs (1 heating sequence and 1 cooling sequence).

- Control to an absolute variable or a differential
- Individually adjustable heating and cooling setpoints (or upper and lower setpoints)
- Adjustable control timeout

Setpoints

- Universal shift: Setpoint can be shifted depending on another variable, or it can be adapted via a remote setpoint adjuster

Bus functions

- Display of fault status messages from other devices via bus
- Output of a common fault status message of all devices on the bus to a fault relay
- Time synchronization
- Delivery and adoption of outside temperature signal

- Forwarding the yearly clock data (time of day, weekday, date, summer- / wintertime changeover) to another controller, or reception of the yearly clock data from another controller
- Reception of the 7-day program from another controller
- Forwarding the yearly program for holidays / special days to another controller or reception of the yearly program for holidays / special days from another controller
- Reception and forwarding of a demand signal (hot or chilled water) for the primary controller or the heat source or refrigeration machine
- Reception and evaluation of refrigeration demand signals if configured as a primary controller or refrigeration machine

2-pipe system for heating / cooling

If a 2-pipe system for heating / cooling is used, the heating / cooling changeover signal received via a digital input can be handled by the unit and forwarded to other bus users via the KNX bus.

Demand for heat and refrigeration

Collection, evaluation and forwarding of heat and refrigeration requests from and via the KNX bus. Also configurable are the following:

- Modulating output (e.g. for demand-dependent setpoint shift of a refrigeration machine)
- Relay output (e.g. for switching a refrigeration machine)
- Demand-dependent setpoint shift acting on the primary controller
- Adjustable setpoint boost when used in connection with a primary controller
- Outside temperature simulation
- Wiring test
- Data backup
- Display of setpoints and actual values

Service and operating functions

Type summary

Switching and Monitoring device	Type reference	Universal inputs	Positioning outputs DC 0...10 V	Switching outputs	Languages loaded
	RMS705-1	8	4	6	de, fr, it, es
	RMS705-2	8	4	6	de, fr, nl, en
	RMS705-3	8	4	6	da, fi, no, sv
	RMS705-4	8	4	6	pl, cs, hu, ru, sk
	RMS705-5	8	4	6	el, ro, sl, sr, hr

Accessories	Description	Type reference	Data Sheet
Operator / service units	Operator unit, plug-in type	RMZ790	N3111
	Operator unit, detached	RMZ791	N3112
	Service tool	OCI700.1	N5655
Extension modules	Universal module with 8 universal inputs	RMZ785	N3146
	Universal module with 4 universal inputs and 4 relay outputs	RMZ787	N3146
	Module connector for detached extension modules	RMZ780	N3138

Ordering and delivery

When ordering, please give name and type reference of the switching and monitoring device, e.g.: Switching and monitoring device **RMS705-2**.

The products listed under "Accessories" must be ordered as separate items.

Equipment combinations

The table below contains the different types of devices that can be used in connection with the RMS705 and the extension modules:

<i>Type of device</i>	<i>Type reference</i>	<i>Data Sheet</i>
Setpoint adjuster, passive	BSG21.1	N1991
Setpoint adjuster, active	BSG61	N1992
Sensors, passive	All types of sensors using a sensing element LG-Ni 1000, Pt 1000, T1 (PTC)	N1721...N1847, N1713
Sensors, active	All types of sensors – operating on AC 24 V – having a DC 0...10 V output	N1821, N1850...N1962
Monitors	QAF81..., QAF64..., QFA81, QFM81, QFA1000, QFA1001, QFX21, QXA2000, QBM81...	N1284, N1283, N1513, N1514, N1518, N1541, N1542 N1552
Signal converter and Processor for absolute humidity and enthalpy	SEZ220	N5146
Variable speed drives	SED2...	N5192
Transformers	SEM62.2	N5536

Product documentation

<i>Type of document</i>	<i>Document no.</i>
Description of Synco™700 product range	CE1S3110en
Basic Documentation (detailed description of all functions)	CE1P3123en
Installation Instructions (mounting and commissioning) G3140	74 319 0398 0
Operating Instructions (de, fr, it, es) B3123x1	74 319 0502 0
Operating Instructions (de, fr, nl, en) B3123x2	74 319 0503 0
Data Sheet "Konnex Bus KNX"	CE1N3127en
Basic Documentation "Communication via Konnex bus for devices of the Synco™700 range and RXB room controllers"	CE1P3127en
CE Declaration of Conformity	CE1T3110xx
Environmental Declaration	CE1E3110en01

Technical design

With the help of the RMZ790 or RMZ791 operator unit, the RMS705 permits free configuration of applications.

For detailed information about the functions, refer to Basic Documentation CE1P3123en.

The RMS705 switching and monitoring unit consists of insert and terminal base. The terminal base has 2 terminal levels and carries the connecting elements (electrical and mechanical) for an extension module. The insert with the printed circuit boards is plugged into the terminal base.

The unit can be mounted on a top hat rail (conforming to EN 60 715-TH35-7.5) or directly on the wall.

Operation takes place via the plug-in type or detached operator unit (refer to section "Accessories").

Operation, indication and connecting elements

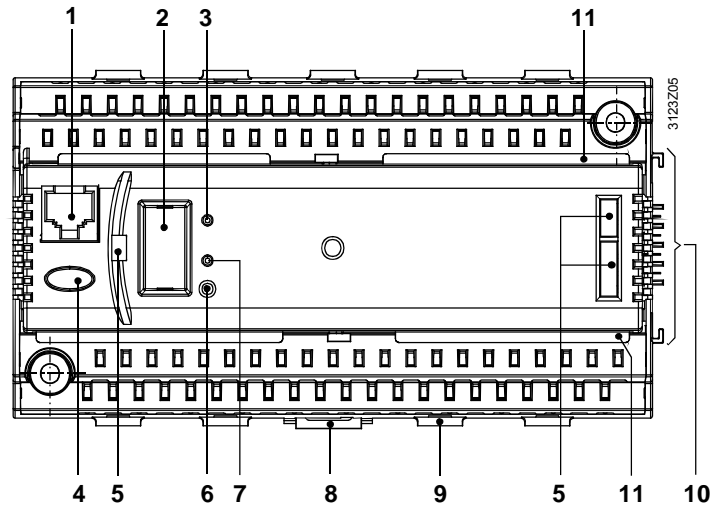

Legend

- 1 Connection facility for service tool (RJ45 connector)
- 2 Removable protective cover with connection facility for operator unit
- 3 LED "RUN" for indicating the unit's operating state:
LED on: Power on, use and peripheral devices ok
LED off: No power or wrong use / peripheral devices faulty
- 4 Button "!" with LED (red) for indicating a fault status message and its acknowledgement:
LED flashing: Fault status message, ready for acknowledgement
LED on: Fault status message still pending but not yet reset
LED off: No fault status message pending
Press button: Acknowledgement or resetting of fault
- 5 Fixing holes for plug-in type operator unit RMZ790
- 6 Programming button "Prog": Learning button for changing between normal mode and addressing mode for adopting the physical device address (tool required)
- 7 Programming LED "Prog" for indicating "Normal mode" (LED off) or addressing mode (LED on) for adopting the physical device address
- 8 Catch for fitting the unit to a top hat rail
- 9 Fixing facility for a cable tie (cable strain relief)
- 10 Electrical and mechanical connecting elements for extension module
- 11 Rest for terminal cover

Engineering notes



- The unit operates on AC 24 V. Operating voltage must conform to the requirements of SELV/PELV (safety extra low-voltage)
- The transformers used must be safety isolating transformers featuring double insulation to EN 60 742 or EN 61 558-2-6; they must be suited for 100 % duty
- Fuses, switches, wiring and earthing must be in compliance with local regulations
- Sensor wires should not be run parallel to mains carrying wires that power fans, actuators, pumps, etc.
- A maximum of 3 extension modules per RMS705 can be connected (possible combinations, see chapter "Functions")

Mounting and installation notes

- The RMS705 and extension modules are designed for:
 - Mounting in a standard cabinet conforming to DIN 43 880
 - Wall mounting on an existing top hat rail (to EN 60715-TH35-7.5)
 - Wall mounting with 2 fixing screws
 - Flush panel mounting
- Not permitted are wet or damp spaces. The permissible environmental conditions must be observed
- If operation shall not take place inside the control panel, the detached operator unit type RMZ791 should be used (in place of plug-in type RMZ790)
- Disconnect the system from power supply prior to mounting the unit
- **The insert must not be removed from the terminal base!**
- If extension modules are used, they must be fitted to the right of the RMS705 observing the correct order in accordance with the internal configuration
- There is no electrical wiring required between the individual extension modules or between the modules and the RMS705. The electrical connections are automatically established when attaching the modules. If it is not possible to arrange all extension modules side by side, the first of the detached modules must be connected to the last module or to the unit via the RMZ780 module connector. In that case, the cumulated cable length must not exceed 10 meters
- The connection terminals for protective extra low-voltage (sensors and data bus) are located in the upper section of the unit, those for mains voltage (actuators and pumps) at the bottom
- Each terminal (spring cage terminal) can accommodate only 1 solid wire or 1 stranded wire. To make the connections, the cables must be stripped for 7 to 8 mm. To introduce the cables into the spring cage terminals and to remove them, a screw driver size 0 or 1 is required. Cable strain relief can be provided with the help of the fixing facility for cable ties
- The RMS705 can be removed from the set of modules on the rail only after the module directly attached to it has been removed
- The unit is supplied complete with Installation and Operating Instructions

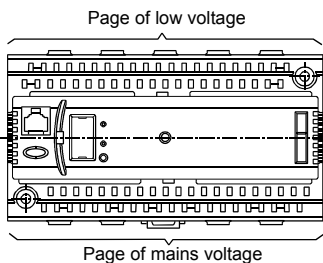

Commissioning notes

- The configuration and parameters of the standard applications offered by the RMS705 can be changed any time by service staff who have been trained by **HVAC Products** and who have the required access rights, either locally with the RMZ790 or RMZ791 operator unit or online / offline with the service tool
- During the commissioning process, the application is deactivated, the outputs are in a defined off state, and no process and alarm signals are delivered to the bus
- On completion of configuration, the unit automatically makes a new start
- When leaving the commissioning pages, the peripheral devices connected to the universal inputs (including the extension modules) are automatically tested and identified. If, at a later stage, a peripheral device is missing, a fault status message will be delivered
- The operator unit can be removed, plugged in or connected during operation
- If adaptations to specific plants are required, they must be recorded and the documentation kept inside the control panel
- For the procedure to be followed when starting up the plant for the first time, refer to the Installation Instructions

General notes

Maintenance	The RMS705 switching and monitoring device is maintenance-free (no battery changes, no fuses). The unit should only be cleaned with a dry cloth.
Repair	The unit cannot be repaired on site.
Disposal	The RMS705 switching and monitoring device is subject to 2002/96/EEC regulations (WEEE, Waste of Electrical and Electronic Equipment). <i>"The device must be disposed of as electronic scrap in compliance with the European directive 2002/96/EEC (WEEE) and not together with municipal waste. The relevant national regulations must be observed using the correct disposal channels. Local and currently valid legislation must be complied with."</i>



Technical data

Power supply (G, G0)	Rated voltage	AC 24 V \pm 20 %
	Safety extra low-voltage (SELV) / protective extra low-voltage (PELV) to Requirements for external safety isolating transformer (100 % duty, max. 320 VA) to	HD 384 EN 60 742 / EN 61 558-2-6
	Frequency	50/60 Hz
	Power consumption (without modules)	12 VA
	Supply line fusing	max. 10 A
Functional data	Backup of clock	48 h typically, min. 12 h
Universal inputs Measured value inputs (X...)	Number	refer to "Type summary"
	Sensors	
	Passive	LG-Ni 1000, T1, Pt 1000 2x LG-Ni 1000 (averaging), 0...1000 Ω , DC 0...10 V
Status inputs (X...)	Active	
	Contact sensing	
	Voltage	DC 15 V
	Current	5 mA
	Requirements for status contacts	
	Signal coupling	potential-free
	Type of contact	maintained contact
	Insulating strength against mains potential	AC 3750 V to EN 60 730
	Requirements for impulse contacts	shielded cables recommended
	Signal coupling	potential-free
	Type of contact	impulse contact
	Mechanical signal source (Reed contact)	
	Max. pulse frequency	25 Hz
	Min. pulse duration	20 ms (incl. max. 10 ms bounce time)
	Electronic signal source	
Max. pulse frequency	100 Hz	
Min. pulse duration	5 ms	
Insulating strength against mains potential	AC 3750 V to EN 60 730	
Perm. resistance		
Contacts closed	max. 200 Ω	
Contacts open	min. 50 k Ω	
Outputs Positioning outputs Y...	Number of positioning and switching outputs	refer to "Type summary"
	Output voltage	DC 0...10 V
	Output current	\pm 1 mA
	Max. load	continuous short-circuit
	Switching outputs AC 230 V (Q1x...Q7x)	External supply line fusing
Non-renewable fuse (slow)		max. 10 A
Automatic line cutout		max. 13 A
Release characteristic		B, C, D to EN 60 898
Relay contacts		
Switching voltage		max. AC 250 V min. AC 19 V
AC current		max. 4 A res., 3 A ind. (cos φ = 0.6)
At 250 V	min. 5 mA	
At 19 V	min. 20 mA	

	Switch-on current	max. 10 A (1 s)
	Contact life at AC 250 V	guide values:
	At 0.1 A res.	2 x 10 ⁷ switching cycles
	At 0.5 A res.	4 x 10 ⁶ switching cycles (NO)
		2 x 10 ⁶ switching cycles (changeover)
	At 4 A res.	3 x 10 ⁵ switching cycles (NO)
		1 x 10 ⁵ switching cycles (changeover)
	Red. factor with ind. loads (cos φ = 0.6)	0.85
	Insulating strength	
	Between relay contacts and system electronics (reinforced insulation)	AC 3750 V to EN 60 730-1
	Between neighboring relay contacts (operational insulation) Q1↔Q2; Q3↔Q4; Q6↔Q7	AC 1250 V to EN 60 730-1
	Between relay groups (reinforced insulation) (Q1, Q2) ↔ (Q3, Q4) ↔ (Q6, Q7)	AC 3750 V to EN 60 730-1
Power supply external devices (G1)	Voltage	AC 24 V
	Current	max. 4 A
Interfaces	Konnex bus	
	Type of interface	Konnex-TP1
	Bus loading number	2.5
	Decentral bus power supply (can be switched off)	25 mA
	Short-time power failure to EN 50 090-2-2	100 ms (with extension module)
	Extension bus	
	Connector specification	4 contacts SELV/PELV
	Number of plug-in cycles	max. 10
	Service tool connection facility	RJ45 connector
Perm. cable lengths	For passive measuring and positioning signals	(Measuring errors can be corrected on "Settings / Inputs" menu)
	Type of signal	
	LG-Ni 1000, T1	max. 300 m
	Pt 1000	max. 300 m
	0...1000 Ω	max. 300 m
	Contact sensing (status and impulse contacts)	max. 300 m
	For DC 0...10 V measuring and control signals	refer to the Data Sheet of the device delivering the signal
	For Konnex bus	max. 700 m
	Type of cable	2-core unshielded, twisted pairs
	For switching outputs (Q1x...Q7x)	max. 300 m
Electrical connections	Connection terminals	spring cage terminals
	For solid wires	dia. 0.6 mm ... 2.5 mm ²
	For stranded wires without ferrules	0.25...2.5 mm ²
	For stranded wires with ferrules	0.25...1.5 mm ²
	Konnex bus connection facility	not interchangeable
Protective data	Degree of protection of housing to IEC 60 529	IP 20 (when mounted)
	Safety class to EN 60 730	suited for use in equipment of safety class II
Environmental conditions	Operation to	IEC 60 721-3-3
	Climatic conditions	class 3K5
	Temperature (housing and electronics)	0...50 °C
	Humidity	5...95 % r.h. (non-condensing)
	Mechanical conditions	class 3M2
	Transport to	IEC 60 721-3-2
	Climatic conditions	class 2K3
	Temperature	-25...+70 °C
	Humidity	<95 % r.h.
	Mechanical conditions	class 2M2
Classification to EN 60 730	Mode of operation, automatic controls	type 1B
	Degree of contamination, controls' environment	2
	Software class	A
	Rated surge voltage	4000 V
	Temperature for ball-pressure test of housing	125 °C

Materials and colors	Terminal base	Polycarbonate, RAL 7035 (light-grey)
	Insert	Polycarbonate, RAL 7035 (light-grey)
	Packaging	corrugated cardboard
Standards	Product safety	
	Automatic electrical controls for household and similar use	EN 60 730-1
	Special requirements for energy controllers	EN 60 730-2-11
	Electromagnetic compatibility	
	For use in industrial and domestic environments	
	Immunity	EN 60 730-1
	Emissions	EN 60 730-1
	Home and Building Electronic Systems (HBES)	EN 50 090-2-2
	CE conformity	
	EMC directive	2004/108/EC
Low-voltage directive	2006/95/EC	
U conformity to		
Australian EMC Framework	Radio Communication Act 1992	
Radio Interference Emission Standard	AS/NZS 3548	
Environmental compatibility	ISO 14001 (Environment)	
The environmental product declaration CE1E3110en01 contains data on environmentally compatible product design and assessments (RoHS compliance, materials composition, packaging, environmental benefit, disposal)	ISO 9001 (Quality) SN 36350 (Environmentally compatible products) 2002/95/EG (RoHS)	
Weight	Without packaging	0.49 kg

Connection diagrams

Internal diagram

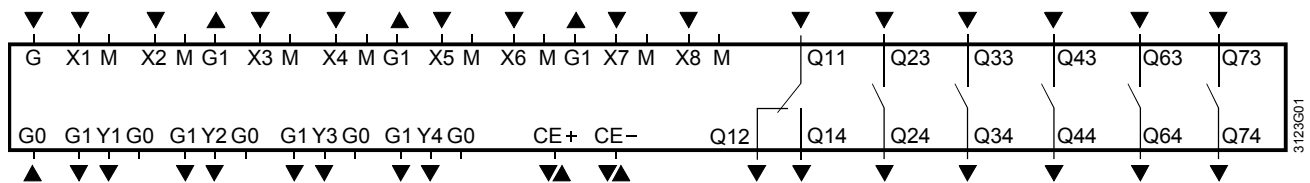

Legend

G, G0	Operating voltage AC 24 V
G1	Output voltage AC 24 V for powering external active devices
M	Measuring neutral for signal input
G0	System neutral for signal output
X1...X8	Universal signal inputs for LG-Ni 1000, 2 x LG-Ni 1000 (averaging), T1, Pt 1000, 0...1000 Ω, DC 0...10 V, pulse, contact sensing (potential-free)
Y1...Y4	Control or status outputs, analog DC 0...10 V
Q...	Potential-free relay outputs for AC 24...230 V
CE+	Konnex bus data line, positive
CE-	Konnex bus data line, negative

Notes

Each terminal can accommodate only 1 solid wire or 1 stranded wire (spring cage terminals). Double terminals are internally interconnected.

Connection diagrams

Connections on the measuring side

Examples:

Diagram 1:
Measuring section with passive sensor

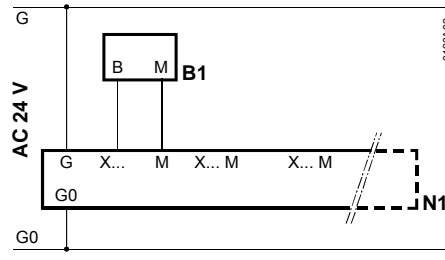

Diagram 2:
Measuring section with active sensor and signal source

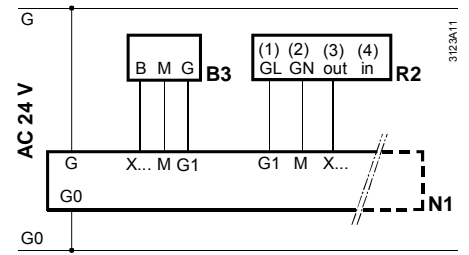
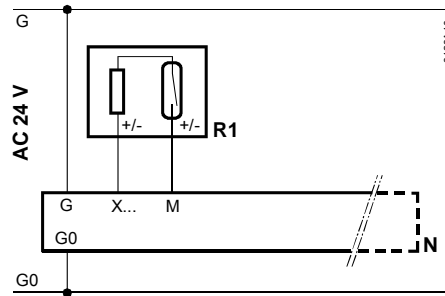

Diagram 3:
Measuring section with pulse source



Recommendation: Use shielded cables

Connections on the switching and monitoring side

Diagram 4:
Multiple use of sensors (B1, N2), external changeover of operating mode (S6)

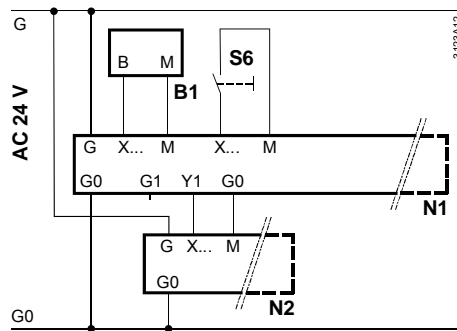
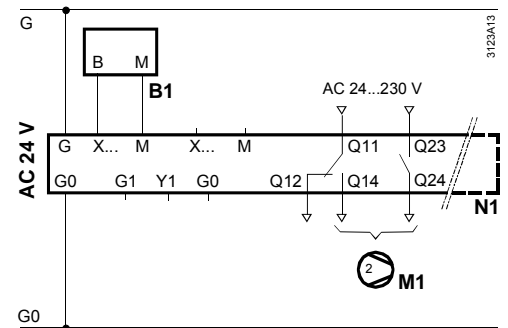

Diagram 5:
Connection of a 2-speed fan



Legend to connection diagrams 1 through 5

- N1 RMS705
- N2 Universal controller RLU210
- B1 Duct temperature sensor QAM21.20...
- B3 Duct temperature sensor QAM2161.040

- R1 Reed pulse source
- R2 Setpoint adjuster BSG61
- S6 H/C changeover switch (manual)
- M1 2-speed fan

Note

For the required internal configuration of the RMS705, refer to Basic Documentation CE1P3123en.

Dimensions

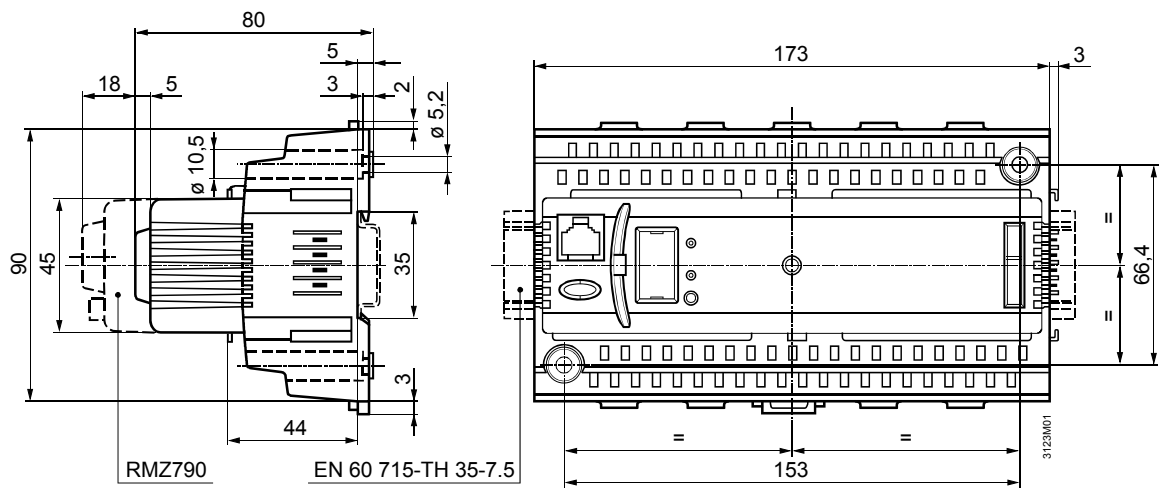

Dimensions in mm