

SIEMENS

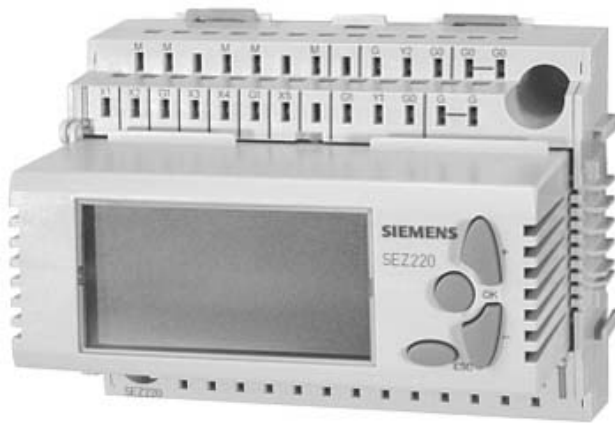

Synco™ 200 SEZ220 signal converter Documentation on basics

Siemens Switzerland Ltd
Building Technologies Group
International Headquarters
Gubelstrasse 22
CH-6301 Zug
Tel. +41 41-724 24 24
Fax +41 41-724 35 22
www.siemens.com/sbt

© 2004-2008 Siemens Switzerland Ltd
Subject to change

Table of contents

1	About this document	5
1.1	Revision history.....	5
1.2	Before you start.....	5
2	Overview	7
2.1	Connections and functions.....	7
2.2	Scope of delivery	7
2.3	Equipment combinations.....	8
2.4	Accessories.....	8
2.5	Product documentation	8
2.6	Important notes	9
3	Operation	10
3.1	Operating elements and display	10
3.2	Operating and access levels.....	12
3.3	Menu structure and navigation.....	14
4	Commissioning	16
4.1	Safety	16
4.2	Begin commissioning.....	16
4.3	Select basic configuration	17
4.4	General settings.....	18
4.5	Three ways to select the right application.....	19
4.6	Wiring test	19
4.7	Exit commissioning	20
5	Analog inputs X1...X5	21
5.1	Activation and setting values	21
5.2	Connection diagrams (examples)	22
5.3	Settings	23
5.4	Error handling.....	24
6	Function block MIN-MAX-AVR	25
6.1	Connections and functions.....	25
6.2	Assign inputs.....	25
6.3	Assign outputs.....	26
6.4	Settings	26
6.5	Error handling.....	27
7	Function block ENTHALPY	28
7.1	Connections and functions.....	28
7.2	Assign inputs.....	28
7.3	Assign outputs.....	28
7.4	Settings	29
7.5	Error handling.....	30

8	Function block 2X-INV	31
8.1	Connections and functions.....	31
8.2	Assign inputs and outputs.....	32
8.3	Settings.....	32
8.4	Error handling.....	33
9	Help in the case of faults	34
9.1	Fault list.....	34
9.2	Fault handling.....	34
10	Electrical connections	35
10.1	Connection rules.....	35
10.2	Connection terminals.....	36
11	Configuration	37
11.1	Configuration principle explained.....	37
11.2	Standard application example.....	38
11.3	Configuration diagram.....	39
12	Application examples	40
12.1	Multiple use of sensors.....	40
12.2	Enthalpy and absolute humidity.....	40
12.3	Average and maximum.....	41
12.4	Average from 6 input signals.....	41
12.5	Signal converter.....	42
12.6	Adapt signal.....	42
12.7	Signal doubler.....	42
13	Appendix	43
13.1	Operating text SEZ220.....	43
Index	45

1 About this document

1.1 Revision history

Changes	Chapter/Section	Pages
New template, e.g. footers	Entire document	
Document retranslated and revised in English (improved wording)	Entire document	
New	Chapter 1	
Menu text changes: CHECK is now INFO	Entire document	12, 14, 15, 17 (ff), 44
EXP level now is PASS level	Entire document	11, 13, 16, 43
New order of menus	3	14
Displays as per the new device	Entire document	10, 12, 15, 16, 20, 34

1.2 Before you start

1.2.1 Copyright

This document may be duplicated and distributed only with the express permission of Siemens, and may be passed only to authorized persons or companies with the required technical knowledge.

1.2.2 Quality assurance

These documents were prepared with great care.

- The contents of all documents are checked at regular intervals.
- Any corrections necessary are included in subsequent versions.
- Documents are automatically amended as a consequence of modifications and corrections to the products described.

Please make sure that you are aware of the latest document revision date.

If you find lack of clarity while using this document, or if you have any criticisms or suggestions, please contact the product manager in your nearest branch office.

The addresses of the Siemens regional companies are available at

www.siemens.com/sbt.

1.2.3 Document use/ request to the reader

Before using our products, it is important that you read the documents supplied with or ordered at the same time as the products (equipment, applications, tools etc.) carefully and in full.

We assume that persons using our products and documents are authorized and trained appropriately and have the technical knowledge required to use our products as intended.

More information on the products and applications is available:

- On the intranet (Siemens employees only) at <https://workspace.sbt.siemens.com/content/00001123/default.aspx>
- From the Siemens branch office near you www.siemens.com/sbt or from your system supplier
- From the support team at headquarters fieldsupport-zug.ch.sbt@siemens.com if there is no local point of contact

Siemens assumes no liability to the extent allowed under the law for any losses resulting from a failure to comply with the aforementioned points or for the improper compliance of the same.

2 Overview

2.1 Connections and functions

Block circuit diagram

The following block circuit diagram shows the SEZ220 connections and function blocks. The function blocks convert the signals to the inputs as per the configuration and parameterization, and provide them via the outputs as DC 0...10 V signals.

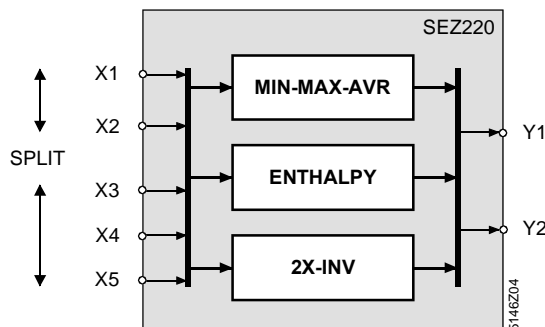

Key

Element	Explanation
X1...X5	Universal inputs for analog, passive, or active signals of various measured values (°C, %, ---).
MIN-MAX-AVR	Function block "Min-max-average".
SPLIT	Configuration parameter. When active, the functions of MIN-MAX-AVR are assigned to inputs X1 – X2 and X3 – X5.
ENTHALPY	Function block "Enthalpy processor".
2X-INV	Function block "Signal doubling / signal inversion".
Y1, Y2	DC 0...10 V outputs.

2.2 Scope of delivery

Overview

Standard applications, functions and connections for the SEZ220:

Subject	Number
Canned applications	13
Basic type M... (MIN-MAX-AVR)	✓
Basic type E... (ENTHALPY)	✓
Basic type D... (2X-INV)	✓
Function blocks	3
MIN-MAX-AVR (min. and max. selection, calculation of average)	1
ENTHALPY (calculation of enthalpy, enthalpy differential, absolute humidity, dewpoint)	1
2X-INV (signal doubling, signal inversion)	1
Universal inputs	5
As analog inputs DC 0...10 V	✓
As analog inputs Ni 1000	✓
As analog inputs T1	✓
As analog inputs 0...1000 Ω	✓
As analog inputs Pt 1000	✓
Modulating outputs DC 0...10 V	2

2.3 Equipment combinations

Possible combinations

The following table shows the devices that can be used with the SEZ220 signal converter:

<i>Device</i>	<i>Type</i>	<i>Data sheet</i>
Passive sensors	All sensors with sensing element LG-Ni 1000, Pt 1000, T1 (PTC).	N1721...N1846, N1713
Passive signal sources	BSG21.1, BSG21.5, QAA25, QAA27	N1991, N1721
Active signal sources	BSG61	N1992
Actuating devices	All electro-motoric and electro-hydraulic actuators: With operating voltage AC 24 V. For continuous DC 0...10 V control. For detailed information on actuators and valves, see:	N4000...N4999

Deploy SEZ220

The SEZ220 signal converter can be used for different tasks together with the RLU2... and RMU7... universal controllers:

- At the outset of a process, e.g. to calculate enthalpy or dewpoint temperature.
- At the end of a process, e.g. to double the signal from a positioning output.

2.4 Accessories

Names and types

The following table contains the accessories for the SEZ220 signal converter:

<i>Name</i>	<i>Type</i>	<i>Data sheet</i>
Service tool	OCI700.1	N5655
Flush panel mounting frame	ARG62.201	N3101

2.5 Product documentation

Supplementary information

The following product documentation provides detailed information on safe and intended use and operation of Synco™ 200 products in building services plants.

<i>Document</i>	<i>Order number</i>
Basic documentation "Signal converter SEZ220"	CE1P5146en
Data sheet "Signal converter SEZ220"	CE1N5146en
Instructions set (mounting, commissioning, operation)	74 319 0425 0
CE Declaration of conformity	CE1T5146xx
Environmental declaration	CE1E5146en

2.6 Important notes



The symbol to the left denotes special safety notes and warnings. Failing to observe these notes may result in injury and/or serious damages.

Field of use	You may only use Synco™ 200 products to control and monitor heating, ventilating, air conditioning, and chilled water plants.
Intended use	Safe and trouble-free operation of Synco™ 200 products presupposes transport, storage, mounting, installation and commissioning as intended as well as careful operation.
Electrical installation	Fuses, switches, wiring and earthing must comply with relevant national safety regulations for electrical installations.
Commissioning	Only qualified staff trained by Siemens Building Technologies may prepare and commission Synco™ 200 products.
Operation	Only persons trained by Siemens Building Technologies or their representatives who are properly informed of the risks may operate Synco™ 200 products.
Wiring	When wiring, strictly separate AC 230 V mains voltage from AC 24 V safety extra-low voltage (SELV) to protect against electrical shock!
Storage and transport	Refer to the environmental conditions specified in the respective data sheets for storage and transport. Contact your supplier or Siemens Building Technologies if you have any questions.
Maintenance	Synco™ 200 products are maintenance-free and require only cleaning at regular intervals. We recommend removing dust and dirt from system components installed in the control panels during standard service.
Faults	Call service staff responsible for your plant in case of system faults; do not diagnose and correct faults.
	Only authorized staff may diagnose and correct faults and recommission the plant. This applies to working within the panel as well (e.g. testing or changing fuses).
Disposal	Devices contain electrical and electronic components; do not dispose of them in the household garbage.

Comply with all local, applicable laws.

3 Operation

3.1 Operating elements and display

3.1.1 Operating elements

View

The following illustration shows the operating elements for the SEZ220 signal converter:

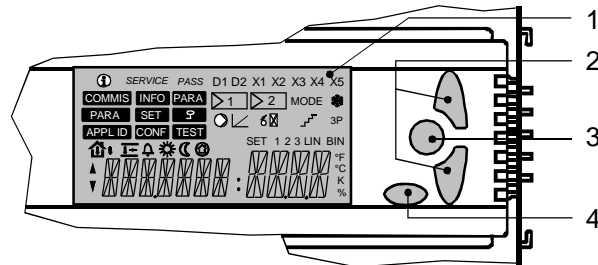

Key

Item	Designation	Properties / function
1	Display	Backlit segment display.
2	+ and – buttons	Navigate and adjust values.
3	OK button	Confirm navigation and value entries.
4	ESC button	Return to the previous menu or abort value entries.

Note

The display above featuring all available symbols only is displayed for a short time, e.g. during startup. The symbols used are explained below.

3.1.2 Display

View / arrangement

The display is subdivided into several logical blocks. The blocks contain symbols associated with specific operating states. They provide current information for the user.

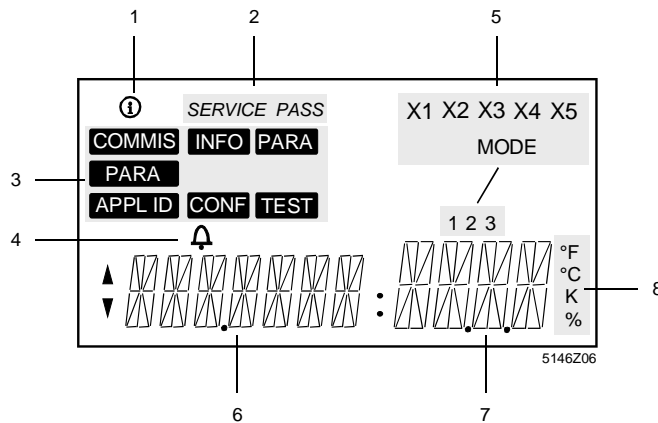

Key

Item	Designation
1	Display Info page.
2	Display access levels.
3	Menu navigation.
4	Fault symbol.
5	Function block navigation.
6	Information segments (7 characters): Text describing data points (abbreviation).
7	Value segments (4 characters): Displays data point values.
8	Display unit.

3.1.3 Symbols on the display

Table of symbols

The following table lists displayed symbols and their meaning. Grouping matches the aforementioned arrangement.

<i>Symbol</i>	<i>Meaning</i>	<i>Symbol</i>	<i>Meaning</i>
Operating level		Function block navigation.	
ⓘ	Info level	X1...X5	Analog inputs X1...X5.
None	Setting level	MODE 1	FB MIN-MAX-AVR
Access level		MODE 2	FB ENTHALPY
SERVICE	Service level	MODE 3	FB 2X-INV
PASS	Password level	Units	
Menus		°F	Degrees Fahrenheit.
COMMISS	Commissioning	°C	Degrees Celsius.
APPL ID	Basic configuration	K	Kelvin.
TEST	Wiring test	%	Percent.
INFO	Inputs/outputs	Navigation	
CONF	Extra configuration	▲	Navigate UP or + value.
PARA	Settings	▼	Navigate DOWN or – value.
Operating modes			
🔔	Fault		

Note on access level

User level is active when neither service level symbol nor password level symbol are displayed.

3.2 Operating and access levels

3.2.1 Operating levels

Two operating levels

The SEZ220 signal converter has two basic operating levels: They are:

- Info level
- Main menu

The following table contains their properties and identification.

<i>Designation</i>	<i>Properties</i>	<i>Identification</i>
Info level	Use this level to display key plant data as INFO pages.	
Main menu	This level is structured as a menu. It allows you to read data points and/or change their values.	None

Note

The two operating levels are always available regardless of the active access level.

Term "data point"

The term "data point" is used as a general term for:

- Real data points with a physical connection to the plant, and
- Fictitious data points without direct connection to the plant (defined solely in software, e.g. setpoints).

All data points are set and read via operating lines on the menu structure. The operating elements allow you to select, display and set data points (setting parameter).

The LCD shows all menus as clear text.

Change between operating levels

Change back and forth between the two operating levels as follows:

- From Info level to main menu: Press **OK**.
- From main menu to Info level: Press **ESC**.

Example for Info page and main menu

The following example shows the above information. The table shows an Info page for the user (top) and a main menu page (bottom):

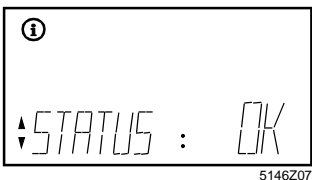
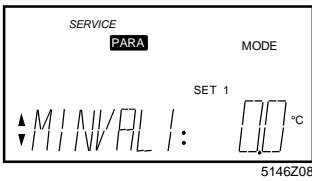
<i>Display</i>	<i>Explanation</i>
 <p>5146Z07</p>	<p>Info level:</p> <ul style="list-style-type: none"> • Change between Info pages using the navigation buttons. • Number and presentation of Info pages depend on the selected application.
 <p>5146Z08</p>	<p>Main menu:</p> <ul style="list-style-type: none"> • Change between different data points using the navigation buttons, here e.g. to MINVAL1. • Change values: <ol style="list-style-type: none"> 1. Press OK. 2. Change the value with the navigation buttons, here e.g. to 0.0 °C. 3. Press OK to assume the value.

3.2.2 Access levels

Three access levels

The SEZ220 signal converter has three access levels: They are:

- User level
- Service level
- Password level

Each data point is assigned to one of these access levels .

Access

The following table contains the three access levels and their purpose, access and symbols:

<i>Level</i>	<i>Access</i>	<i>Symbol</i>
User level (for plant operator)	The user level can be accessed any time. The SEZ220 only shows Info pictures.	None
Service level (for maintenance tasks)	1. Press OK and ESC simultaneously. 2. Press + / - to select service level SERV. 3. Confirm the selection by pressing OK.	<i>SERVICE</i>
Password level (for commissioning)	1. Press OK and ESC simultaneously. 2. Select the password level PASS by pressing + / - . 3. Confirm the selection by pressing OK. 4. When PASSWRD is displayed, press + and select 2. 5. Confirm the selection by pressing OK.	<i>PASS</i>

Common properties

The three access levels share the following properties:

- Individual menus or individual operating lines are enabled depending on the access level.
- A higher access level also shows the menus and operating lines for the lower access levels.
- The levels use a shared menu as a basis. The password level contains the entire menu.
- After a timeout of 30 minutes, the signal converter changes to the user level.
Timeout: Period of time during which the unit is not operated.

3.3 Menu structure and navigation

3.3.1 Menu structure

Levels and menus

The submenus are shown or hidden depending on the selected access level:

<i>User level</i>	<i>Service level</i>	<i>Password</i>
Info level Info pictures 1...n	Info level Info pictures 1...n	Info level Info pictures 1...n
	↓ OK ESC ↑	↓ OK ESC ↑
	Main menu INFO (Inputs/outputs) PARA (Settings)	Main menu COMMIS (Commissioning) PARA (Settings) APPL ID (Basic configuration) CONF (Extra configuration) TEST (Wiring test) INFO (Inputs/outputs) PARA (Settings)

User level information

The user level only provides access to Info pictures 1...n.

3.3.2 Menu navigation

Example

The pictures below show menu navigation based on the following example:
Set minimum value MINVAL1 in MIN-MAX-AVR function block.

Starting point:

- Access level *SERVICE*
- Info level

Step Display

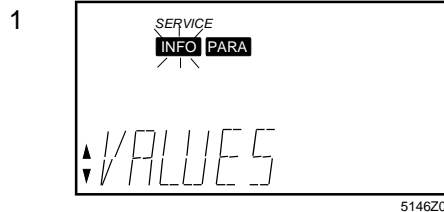

Procedure / results

1. Press **OK**:
=> The first menu item flashes, here **INFO** (inputs / outputs).

Note: Text explaining the menu is displayed together with the information segments (here *VALUES*).

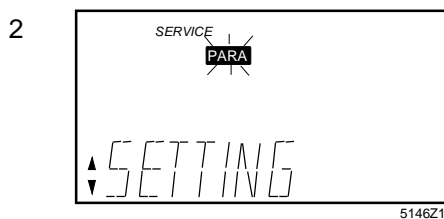

1. Press - (down) to go to menu item **PARA** (Settings):
=> **PARA** flashes.
2. Confirm by pressing **OK**.

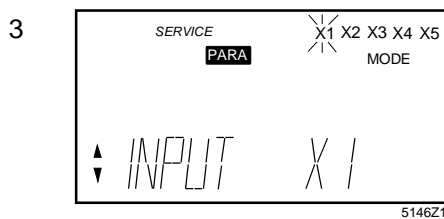

Function block selection is displayed and the first function block (X1) flashes.



1. Press - (down) to go to menu item **MIN-MAX-AVR**.
2. Confirm by pressing **OK**.



Parameter selection is displayed (information segments at bottom left).

1. Press + / - to go to the desired parameter (MINVAL1) and then **OK**:
=> The corresponding value flashes.
2. Press + / - to select the required value (here 0.0 °C) and confirm by pressing **OK**.
=> The new value is saved.

4 Commissioning

4.1 Safety



Only qualified staff trained by Siemens Building Technologies may prepare and commission the SEZ220 signal converter.

4.2 Begin commissioning

4.2.1 Initial startup

Procedure

The commissioning menu automatically starts when AC 24 V operating voltage is supplied to the signal converter. Note:



During commissioning, the application is not active. The outputs are in a defined OFF state.

Basic settings

The following settings are displayed as soon as the signal converter is started:

- Access level **PASS** (Password level).
- **COMMIS** (Commissioning) menu with flashing menu item **PARA** (Settings).

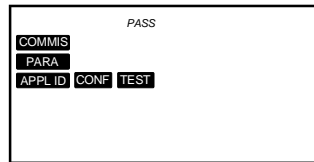

4.2.2 Start from main menu

Prerequisite

The **COMMIS** (Commissioning) menu is active only at the Password level (Password = 2). If not yet selected, press **ESC** and **OK** at the same time to go to the access level.

Application is deactivated

When changing from the main menu to commissioning, the user is informed that the application is deactivated:

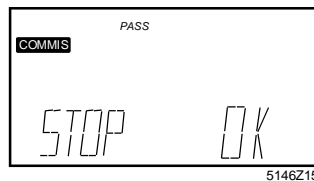

The following happens after you press **OK**:

- The application is deactivated.
- All outputs are set to a defined OFF state.
- The **COMMIS** (Commissioning) menu items are displayed, **PARA** (Settings) flashes; see picture above under "Basic settings".
- Press + or – to select menu **APPL ID** (Basic configuration).

4.3 Select basic configuration

4.3.1 Select basic type

APPL ID menu

First, enter the basic type in the unit. Selecting the basic type via menu **APPL ID** (Basic configuration) enables or disables functions. The SEZ220 provides the following basic types:

- M Empty configuration.
- Mxx Applications with MIN-MAX-AVR functions.
- Exx Applications with ENTHALPY function.
- Dxx Applications with 2X-INV function.

4.3.2 Select programmed application

Selection

The unit contains tested, programmed applications. They are described in data sheet CE1N5146en.

The easiest way to commission the unit is to activate one of these programmed applications and to adapt the configuration as needed.

Select the application via **COMMIS > APPL ID**, and confirm with **OK**.

Selection exampleLine APPL ID displays: M01

This means:

M Standard application, basic type M.

01 First number of this basic type.

Information in INFO menu

The **INFO** menu contains data point APPL ID: It provides information on:

- If the programmed application was changed (ADAP = adapted), or
- If it was not changed (ORIG = original).

*Note on basic type M*Note the following on basic type M:

- The empty configuration M allows for freely configuring MIN-MAX-AVR functions. The outputs are undefined.
- Selecting M triggers a reset:
A free configuration are reset to undefined state!

4.3.3 Settings

Configuration

Path: **COMMIS > APPL ID**

<i>Display</i>	<i>Name</i>	<i>Range / comment</i>
APPL ID	Plant type	Set basic type: M, Mxx, Exx, Dxx.

Display values

Path: **INFO**

<i>Display</i>	<i>Name</i>	<i>Comment</i>
APPL ID	Plant type	Displays basic type / adapted or original.

4.4 General settings

4.4.1 Select unit

Setting values

The unit for temperature can be changed between °C and °F:

Path: ... > **PARA** > **MODE**

<i>Display</i>	<i>Name</i>	<i>Range</i>	<i>Factory setting</i>
UNIT	Unit	°C, °F	°C

4.4.2 Device information

Display values

The software version used can be displayed:

Path: **INFO**

<i>Display</i>	<i>Name</i>	<i>Comment</i>
VERSION	Software version	

4.5 Three ways to select the right application

4.5.1 Programmed application

Easiest

The easiest way to commission the unit is to activate a programmed application and adapt the configuration to the requirements of the relevant plant. Data sheet CE1N5146en describes the programmed applications.

4.5.2 Adapted application

Strike a balance

The programmed application is not quite right, but data sheet CE1N5146en describes an adapted application. In this case, enter your adaptations via the **CONF** (Extra configuration) menu. Press **OK** to save the settings.

4.5.3 Free configuration

Most complex

The desired application is not described and the configuration must be created from scratch: This includes the following:

- Complete the configuration diagram for the desired application (see chapter 10).
- Configure the unit by selecting basic type M (MIN-MAX-AVR).

Note

You can cancel or recreate an existing free configuration or parts thereof any time by selecting and confirming basic type M.

4.6 Wiring test

Functions

When peripheral devices are connected, test the wiring via the TEST (wiring test) menu. We recommend testing after configuration and settings are complete. The test provides the following functions:

- Display reading values for inputs.
- Display reading values for outputs.



The application is not active during the wiring test. The outputs are in a defined OFF state.

Error checks

During wiring test, both inputs and outputs are checked for the following errors:

- Connection error (mixed up wires).
- Position error (mixed up sensors or actuating devices).
- Discrepancy between connections and configuration (e.g. LG-Ni 1000 in place of active DC 0...10 V).

4.7 Exit commissioning

User information

After quitting the **COMMIS** (Commissioning) menu, pressing **ESC** displays the following information telling the user that the plant is started:

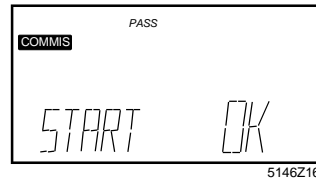

Plant is started

The following happens after you press **OK**:

- Application starts:
 - All sensors are checked, and
 - Existing sensors are marked for future fault status messages.
- The display changes to the next higher menu level and the first menu symbol **COMMIS** flashes:

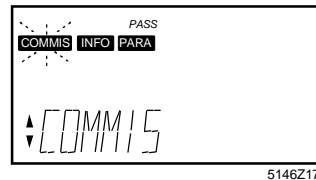

Exit

Press **ESC** once.

If the signal converter is in normal mode, an Info page is displayed:

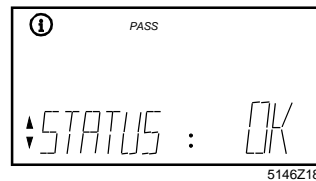

5 Analog inputs X1...X5

5.1 Activation and setting values

Connectable signals

The following signals can be connected to universal inputs X1...X5 at the SEZ220 signal converter:

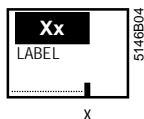

- Passive analog signals.
- Active analog signals.

Activate the function

Universal Xx inputs are always available. If not required for their functionality, they can be used for diagnostics purposes.

To activate, assign each input used to a LABEL (identifier). The identifier also defines the input's unit. The following identifiers are available:

<i>LABEL (identifier)</i>	<i>Explanation</i>
TEMP	Temperature sensor without any ready assigned functionality (type), unit °C / °F.
%	DC 0...10 V signal, unit %.
0.0	Universal input with 1 decimal, resolution -99.9...+999.9, increment 0.1.
0000	Universal input with no decimal, resolution -999...+9999, increment 1.

Setting value TYPE

The following types (TYPE) are available for the identifier TEMP:

- NI (LG-Ni 1000)
- 2XNI (2 x Ni1000)
- T1 (T1)
- PT (Pt 1000)
- 0-10 (DC 0...10 V)
- Ohm (0...1000 Ω)

The type is always DC 0...10 V for identifiers %, 0.0 or 0000.

Measuring ranges passive temperature signals

The measuring ranges for the passive temperature signals are defined as follows:

<i>Temperature signal</i>	<i>Measuring range</i>
LG-Ni 1000	-50...+250 °C
2 x Ni 1000 or T1	50...150 °C
Pt 1000	50...400 °C

Measuring range active signals and 0...1000 Ω

You can set the measuring range by entering a minimum and maximum value for DC 0...10 V signals and 0...1000 Ohm resistance signals.

Example:

Room temperature with an active DC 0...10 V signal = 0...50 °C:

- Minimum measured value (MIN VAL): 0 °C
- Maximum measured value (MAX VAL): 50 °C

Setting value CORR

You can enter a measured value correction (CORR) for passive temperature sensors aimed at compensating line resistance.

This allows for on-site calibration using a reference measuring instrument.

5.2 Connection diagrams (examples)

Connection diagram LG-Ni 1000 sensor

A passive LG-Ni 1000 temperature sensor can be connected to the unit's input. Connect as follows:

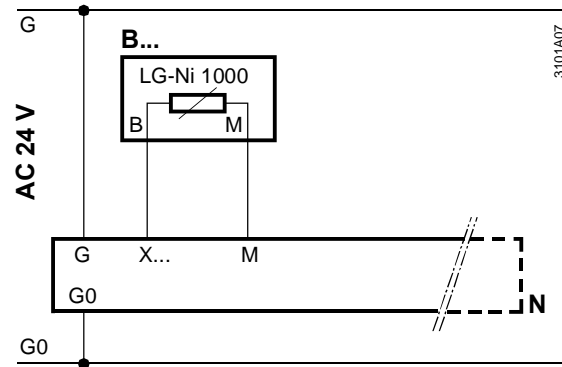

Connection diagram 2 x LG-Ni 1000

Two passive LG-Ni 1000 temperature sensors can be connected to the unit's input. The unit calculates the average temperature. Connect the sensors as follows:

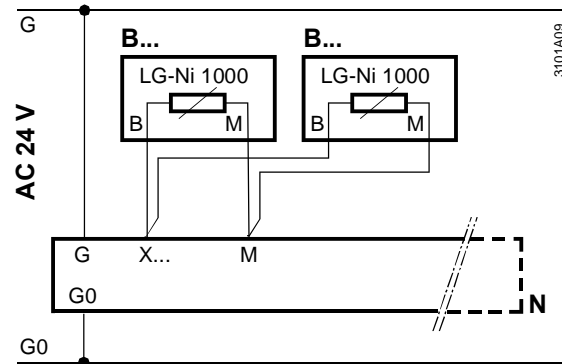

Connection diagram T1

A passive T1 temperature sensor can be connected to the unit's input. Connect as follows:

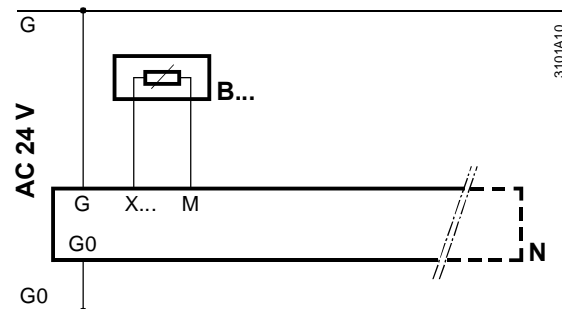

Connection diagrams (examples), *continued*

Connection diagram DC 0...10 V

An active sensor can be connected to the unit's input. Connect as follows:

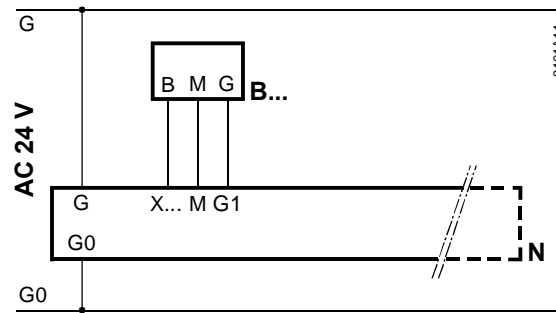

Connection diagram 0...1000 Ω

A passive setpoint adjuster (e.g. QAA25 or BSG21.1) can be connected to the unit's input. Connect as follows:

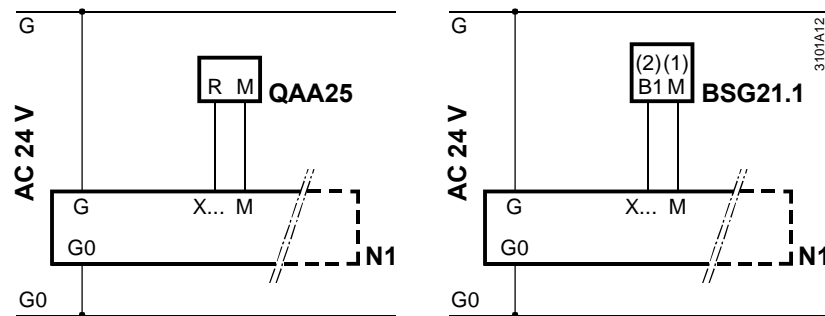

5.3 Settings

Configuration

Path: **COMMIS > CONF > INPUT X1...X5**

Display	Name	Range / comment
LABEL	Input identifier	Assignment of TEMP, %, 0.0, 0000.

Setting values

Path: **... > PARA > INPUT X1...X5**

Display	Name	Range	Factory setting
TYPE	Type	NI, 2XNI, T1, PT, 0-10, OHM	NI
MIN VAL	Value low	-999.9...+9999.9	0
MAX VAL	Value high	-999.9...+9999.9	100
CORR	Correction	-3.0...+3.0	0 K

Display values

Path: **INFO**

Display	Name	Comment
X1	X1	Display current measured value at terminal X1.
...
X5	X5	Display current measured value at terminal X5.

Settings, *continued*

Wiring test

Path: ... > **COMMIS** > **TEST**

<i>Display</i>	<i>Name</i>	<i>Positions</i>
X1	X1	Display the current measured value at terminal X1, non-adjustable.
...
X5	X5	Display the current measured value at terminal X5, non-adjustable.

Fault status messages

<i>Display.</i>	<i>Name</i>	<i>Impact</i>
Xx --- / ooo	Sensor error Xx	Non-urgent fault (Simple Alarm, Prio Low, without plant stop).

5.4 Error handling

Monitor input signals

When quitting the COMMIS (Commissioning) menu, the unit checks which input signals are connected:

- A sensor error message is displayed when one of these signals is subsequently missing:
 - "Xx ---" Signal missing (e.g. in the event of a cable break).
 - "Xx ooo" Short-circuit (only applicable to passive signals).
- Outputs are set to predetermined values when the function blocks are unable to run calculations due to a missing input signal (see function block section "Error handling").

Exercise caution when changing identifiers!

Changing the identifier for an inputs after the configuration for the other function blocks is completed may cause certain functions for these blocks to become inactive as otherwise they would have to operate on invalid units.

6 Function block MIN-MAX-AVR

6.1 Connections and functions

Connections

The following illustration displays the function block connections and selection fields as shown on the configuration sheet:

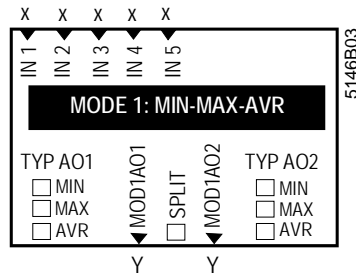

See below for assigning connections (inputs and outputs).

Function types

The function block calculates the following based on signals received at inputs IN 1 – IN 5:

- Selection of minimum input signal (MIN)
- Selection of maximum input signal (MAX)
- Calculation of average value (AVR)

Configuration parameter SPLIT

When configuration parameter SPLIT is active, the above calculations are applied separately to these 2 ranges:

- Inputs IN 1 – IN 2
- Inputs IN 3 – IN 5

Note

The calculations do not consider non-configured inputs.

6.2 Assign inputs

Activate function block

The function block is activated through the following assignments:

- At least 1 analog input Xx, **and**
- At least 1 of the 2 outputs Y1 or Y2.

Valid identifiers

Each analog input Xx can be assigned with a valid identifier to function block MIN-MAX-AVR. Valid identifiers are TEMP, %, 0.0, and 0000.

Note on averaging

When calculating the average, the first input IN 1 can be assigned more weight via configuration parameter FACTIN1 .

Example:

Enter average value of 5 signals at input 1 and provide signals to the other 4 inputs.

Result:

The output provides the average of 9 input signals.

6.3 Assign outputs

Assignment rules without SPLIT

When configuration parameter SPLIT is inactive, the following applies:

- 1 of the 3 function types MIN, MAX and AVR can be assigned to each output (parameter MOD1AOx / TYP AOx).
- Each of the assigned function types considers all active inputs.
- The value range of output Y1 can be specified with parameters MINVAL1, MAXVAL1. The same applies to output Y2 (MINVAL2, MAXVAL2).
Example: DC 0...10 V corresponds to 0...50 °C.

Assignment rules with SPLIT

When SPLIT is active, the following applies:

- 1 of the 3 function types MIN, MAX and AVR can be assigned to each output (parameter MOD1AOx / TYP AOx).
- The first output (AO1) with its function type considers input range IN 1 – IN 2.
- The second output (AO2) with its function type considers input range IN 3 – IN 5.
- The value range of output Y1 can be specified with parameters MINVAL1, MAXVAL1. The same applies to output Y2 (MINVAL2, MAXVAL2).
Example: DC 0...10 V corresponds to 0...50 °C.

6.4 Settings

Configuration

Path: **COMMIS > CONF > MIN-MAX-AVR**

<i>Display</i>	<i>Name</i>	<i>Settings</i>
IN 1	Input 1	---, X1...X5
IN 2	Input 2	---, X1...X5
IN 3	Input 3	---, X1...X5
IN 4	Input 4	---, X1...X5
IN 5	Input 5	---, X1...X5
SPLIT	Inputs segregated	NO, YES
MOD1AO1	Min-max average output 1	---, Y1, Y2
MOD1AO2	Min-max average output 2	---, Y1, Y2
TYP AO1	Function type output 1	MIN, MAX, AVR
TYP AO2	Function type output 2	MIN, MAX, AVR

Setting values

Path: **... > PARA > MIN-MAX-AVR**

<i>Display</i>	<i>Name</i>	<i>Range</i>	<i>Factory setting</i>	
			<i>TEMP</i>	<i>% or 0</i>
FACTIN1	Factor input 1	1...100	1	1
MINVAL1	Value low 1	-999.9...+9999.9	-50	0
MAXVAL1	Value high 1	-999.9...+9999.9	250	100
MINVAL2	Value low 2	-999.9...+9999.9	-50	0
MAXVAL2	Value high 2	-999.9...+9999.9	250	100

Settings, continued

Display values

Path: **INFO**

Display	Name	Comments
MIN 1	Minimum 1	Smallest value of the input signals assigned to output Y1 (in the respective unit).
MAX 1	Maximum 1	Biggest value of the input signals assigned to output Y1 (in the respective unit).
AVR 1	Average 1	Average value of the input signals assigned to output Y1 (in the respective unit).
MIN 2	Minimum 2	Smallest value of the input signals assigned to output Y2 (in the respective unit).
MAX 2	Maximum 2	Biggest value of the input signals assigned to output Y2 (in the respective unit).
AVR 2	Average 2	Average value of the input signals assigned to output Y2 (in the respective unit).

Note on MIN display

If setting values are defined for MINVAL and MAXVAL, Yx output signal does not necessarily correspond to the displayed minimum and maximum values.

Example:

- MINVAL1 is set to 20 °C.
- The assigned input signals are 12 °C, 20 °C and 60 °C.
- 12 °C is displayed under MIN 1.
- However, output signal Y1 is DC 0 V (because MINVAL = 20 °C).



Wiring test

Path: **COMMIS > TEST**

Display	Name	Positions
MOD1AO1	Min-max average output 1	---, 0...100 %
MOD1AO2	Min-max average output 2	---, 0...100 %

6.5 Error handling

A check identifies available input signals after quitting the COMMIS (commissioning) menu. We differentiate between two cases if one of the input signals previously acquired is missing due to short-circuit or open circuit:

Case	Description	Display
1	At least 1 input signal is missing, but calculation is still possible.	Fault symbol  . The calculated values are displayed (Info pictures and INFO menu (Inputs/outputs)).
2	At least 1 input signal is missing, and calculation is not possible.	Fault symbol  . Values: MIN = 0; MAX = 0; AVR = 0.

The relevant input is not monitored if one of the input signals is missing after you quit the COMMIS (commissioning) menu.

Note

Section 5.4 describes how to handle errors of inputs Xx.

7 Function block ENTHALPY

7.1 Connections and functions

Connections

The following illustration shows the function block connections as shown on the configuration sheet:

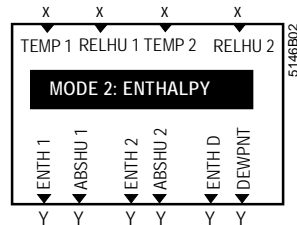

See below on how to assign connections (inputs and outputs).

Functions

The function block calculates the following from its input signals TEMP 1 / RELHU 1 and TEMP 2 / RELHU 2:

- Enthalpy based on temperature and relative humidity.
- Absolute humidity based on temperature and relative humidity.
- Enthalpy differential based on 2 temperatures and 2 relative humidity values.
- Dewpoint temperature based on temperature TEMP 1 and relative humidity RELHU 1.

The results of the calculations are provided as DC 0...10 V signals.

7.2 Assign inputs

Activate function block

The function block is activated through the following assignments:

- At least 2 inputs, **and**
- At least 1 of the 2 outputs.

Valid identifiers

- Any analog input Xx with valid identifier can be assigned to the ENTHALPY function block. Valid identifiers are TEMP, %, 0.0, and 0000.

7.3 Assign outputs

7.3.1 Activation and value ranges

Value ranges

The value ranges of the output signals are limited and cannot be changed. The DC 0...10 V output signal corresponds to the following value ranges:

<i>Display</i>	<i>Name</i>	<i>Unit</i>	<i>Y MIN</i>	<i>Y MAX</i>
ENTH 1	Enthalpy 1	kJ/kg	0	100
ABSHU 1	Absolute humidity 1	g/kg	0	20
ENTH 2	Enthalpy 2	kJ/kg	0	100
ABSHU 2	Absolute humidity 2	g/kg	0	20
ENTH D	Enthalpy difference	KJ/kg	-50	+50
DEWPNT	Dew point	° C	0	50

7.4 Settings

Configuration

Path: **COMMIS > CONF > ENTHALPY**

<i>Display</i>	<i>Name</i>	<i>Settings</i>
TEMP 1	Temperature input 1	---, X1...X5
RELHU 1	Relative humidity input 1	---, X1...X5
TEMP 2	Temperature input 2	---, X1...X5
RELHU 2	Relative humidity input 2	---, X1...X5
ENTH 1	Enthalpy 1	---, Y1, Y2
ABSHU 1	Absolute humidity 1	---, Y1, Y2
ENTH 2	Enthalpy 2	---, Y1, Y2
ABSHU 2	Absolute humidity 2	---, Y1, Y2
ENTH D	Enthalpy difference	---, Y1, Y2
DEWPNT	Dew point	---, Y1, Y2

Setting values

Path: **... > PARA > MODE 2**

<i>Display</i>	<i>Name</i>	<i>Unit</i>	<i>Range</i>	<i>Factory setting</i>
ALTIT	Elevation above sea level	m	0...5000, adjustable in increments of 10 m.	500

Display values

Path: **INFO**

<i>Display</i>	<i>Name</i>	<i>Comments</i>
ENTH 1	Enthalpy 1	
ABSHU 1	Absolute humidity 1	
ENTH 2	Enthalpy 2	
ABSHU 2	Absolute humidity 2	
ENTH D	Enthalpy difference	
DEWPNT	Dew point	



Wiring test

Path: **COMMIS > TEST**

<i>Display</i>	<i>Name</i>	<i>Positions</i>
ENTH 1	Enthalpy 1	---, 0...100 %
ABSHU 1	Absolute humidity 1	---, 0...100 %
ENTH 2	Enthalpy 2	---, 0...100 %
ABSHU 2	Absolute humidity 2	---, 0...100 %
ENTH D	Enthalpy difference	---, 0...100 %
DEWPNT	Dew point	---, 0...100 %

7.5 Error handling

A check identifies available input signals after quitting the COMMIS (commissioning) menu. We differentiate between two cases if one of the input signals previously acquired is missing due to short-circuit or open circuit:

<i>Case</i>	<i>Description</i>	<i>Display</i>
1	At least 1 input signal is missing, but calculation is still possible.	Fault symbol  . The calculated values are displayed (Info pictures and INFO menu (Inputs/outputs)).
2	At least 1 input signal is missing, and calculation is not possible.	Fault symbol  . Values according to the table below.

Calculation not possible If calculation is not possible (case 2), the following predefined values are displayed:

<i>Function</i>	<i>Value</i>
ENTH x	0 kJ/kg
ABSH x	0 g/kg
ENTH D	-50 kJ/kg
DEWPNT	0 °C

The relevant input is not monitored later if one of the input signals is missing after you quit the COMMIS (commissioning) menu.

Note

See section 5.4 on how to handle input errors.

8 Function block 2X-INV

8.1 Connections and functions

Connections

The following illustration shows the function block connections as shown on the configuration sheet:

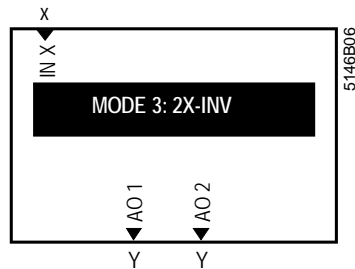

See below on how to assign connections (inputs and outputs).

Functions

The function block provides these functions :

- Limit the input signal's low and high value (MIN VAL, MAX VAL) for each of the output signals AO 1 and AO 2.
- Adapt the low and high value (MIN POS, MAX POS) for each of the output signals AO 1 and AO 2.
- Invert output signals AO 1 and AO 2.

Corresponding signals in the DC 0...10 V range appear at the outputs.

Function diagrams

The following function diagrams illustrate the above statements. Limitation of input signal X is selected to result in signal doubling, with AO 2 starting to operate after control of AO 1.

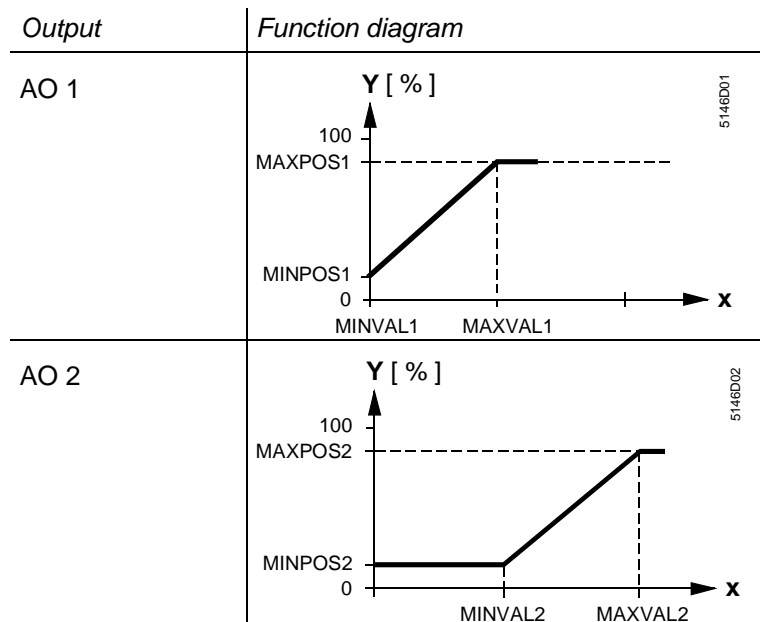

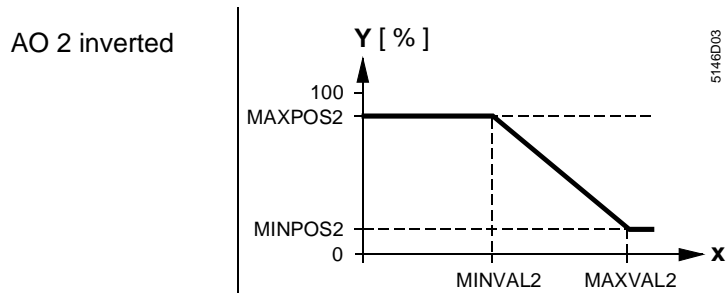

8.2 Assign inputs and outputs

Activate function block

The function block is activated through the following assignments:

- Input IN X, and
- At least 1 of the 2 outputs AO x.

You can define the measuring or value range of IN X when configuring the associated input Xx (see Section 5).

8.3 Settings

Configuration

Path: **COMMIS > CONF > 2X-INV**

Display	Name	Settings
IN X	Preselection external	---, X1...X5
AO 1	Modulating output 1	---, Y1, Y2
AO 2	Modulating output 2	---, Y1, Y2

Setting values

Path: **... > PARA > 2X-INV**

Display	Name	Range	Factory setting
MINPOS1	Dew point	0...100 %	0
MAXPOS1	Positioning signal max 1	0...100 %	100
MINVAL1	Value low 1	-50...+9999.9	0
MAXVAL1	Value high 1	-50...+9999.9	50
INVERS1	Inversion 1	NO, YES	NO
MINPOS2	Positioning signal min 2	0...100 %	0
MAXPOS2	Positioning signal max 2	0...100 %	100
MINVAL2	Value low 2	-50...+9999.9	0
MAXVAL2	Value high 2	-50...+9999.9	50
INVERS2	Inversion 2	NO, YES	NO

Display values

Path: **INFO**

Display	Name	Comments
AO 1	Modulating output 1	0...100 %
AO 2	Modulating output 2	0...100 %

Wiring test

Path: **COMMIS > TEST**

Display	Name	Positions
AO 1	Modulating output 1	---, 0...100 %
AO 2	Modulating output 2	---, 0...100 %

Settings, *continued*

Example of MIN POS / MAX POS

Assumption:

The parameter settings are MIN POS = 15 % and MAX POS = 65 %.

In this case:

INVERS = NO:	0 % => Minimum positioning signal	DC 1.5 V
	100 % => Maximum positioning signal	DC 6.5 V
INVERS = YES:	0 % => Minimum positioning signal	DC 6.5 V
	100 % => Maximum positioning signal	DC 1.5 V

Notes on the wiring test

When testing the wiring, note the following:

- If an AOx output is inverted, it also applies to the wiring test. The following always applies:
INVERS = NO: 0...100% corresponds to DC 0...10 V
INVERS = YES: 0...100% corresponds to DC 10...0 V
- Adaptations with MIN POS and MAX POS are also effective with the wiring test.
Example:
MIN POS be set to 20%.
When entering 0%, the voltage at the output is not DC 0 V, but DC 2 V.

8.4 Error handling

A check identifies an available input signal after quitting the COMMIS (commissioning) menu. Fault symbol  indicates a fault on the display if the acquired input signal later is missing due to short circuit or open circuit. In this case, the values of AO 1 and AO 2 cannot be calculated. The values are set to 0 (zero).

Note

See section 5.4 on how to handle input errors.

9 Help in the case of faults

9.1 Fault list

Causes for faults

The following list contains all possible causes for faults, their display and priority.

Display	Cause for fault	Priority	Effect
X1 --- / ooo	Sensor error X1 Type: Simple Alarm	1	See Sect. 5.4
X2 --- / ooo	Sensor error X2 Type: Simple Alarm	2	ditto
X3 --- / ooo	Sensor error X3 Type: Simple Alarm	3	ditto
X4 --- / ooo	Sensor error X4 Type: Simple Alarm	4	ditto
X5 --- / ooo	Sensor error X5 Type: Simple Alarm	5	ditto
STATUS OK	Display in normal operation	6	

Key

Display	Meaning
---	Open circuit
ooo	Short circuit

9.2 Fault handling

Display and measures

A plant fault is displayed by symbol :

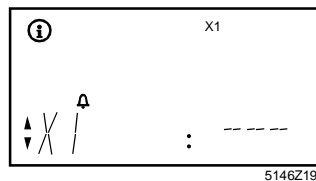

Remove fault.

After removing the fault, the fault display disappears automatically and info picture "STATUS: OK" is displayed:

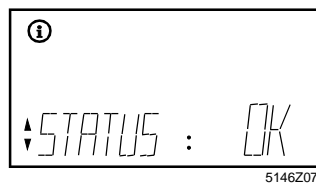

10 Electrical connections

10.1 Connection rules

Synco 200 terminal connection concept

The following illustration shows the terminal block for the SEZ220 signal converter and its connection terminals:

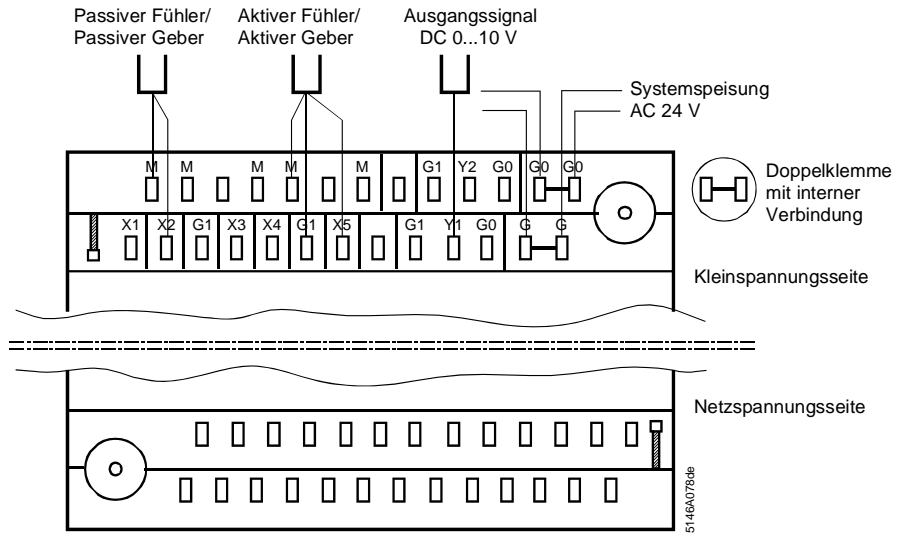

Terminal assignment

Terminal	Used for ...
Xx, M	Passive sensors and signal sources.
G1, Xx, M	Active sensors and signal sources.
Yx	Provide measured values to control devices, sequential control of pumps, valves, fans, etc..
G und G0	AC 24 V power supply.

Note

Only one solid or one stranded wire can be connected per terminal.

Connection procedure with spring cage terminals

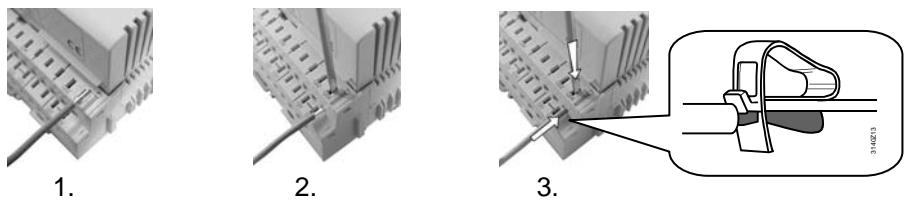

Steps

1. Strip wire for 7 to 8 mm.
2. Locate wire and screwdriver size 0 or 1.
3. Push screwdriver down and, at the same time, insert the wire.
4. Remove the screwdriver.

10.2 Connection terminals

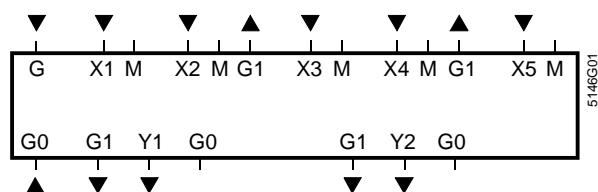

Key

G, G0	Rated voltage AC 24 V.
G1	Power supply AC 24 V for active sensors or signal sources.
M	Measuring neutral for signal input.
G0	System ground for signal output.
X1...X5	Universal signal inputs (analog signals only) for LG-Ni 1000, 2x LG-Ni 1000, T1, Pt 1000, DC 0...10 V, 0...1000 Ω.
Y1, Y2	Measured value or control outputs, analog DC 0...10 V.

11 Configuration

11.1 Configuration principle explained

Configuration diagram, contents

The SEZ220 signal converter comes with a number of preconfigured function blocks. See the configuration diagram below. They comprise:

- Inputs (input identifier, input function).
- Function blocks MIN-MAX-AVR, ENTHALPY and 2X-INV.

Configuration diagram, use

Planning engineers use the configuration diagram to draw connections between individual input and output functions (or their internal signals) and the assigned terminals.

Designations

Physical inputs:

- X universal (for analog signals only in the SEZ220).

Physical outputs:

- Y DC 0...10 V

Use of inputs Xx

The following rules and properties apply to inputs:

- Multiple use of inputs is possible.
- Fault indication for inputs is active only if the input was connected prior to commissioning.
- All related settings change when you change an input identifier.

Configuration procedure

Order:

- Basic configuration (APPL ID) first, then extra configuration (CONF).
- Input identifiers first, then function blocks.

Possible wiring:

- From function block to input: "x" to "x".
- From function block to output terminal: Analog "Y" to "Y".

Use of outputs Yx

The following applies to outputs:

- Each output terminal can be used only once.

11.2 Standard application example

Task

The following two operations are to apply to all active input signals:

- Calculate average.
- Select maximum input signal.

Note: The example corresponds to standard application M03.

Connection diagram

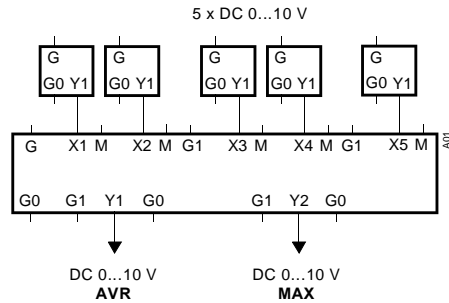

Comment: The active signal sources shown serve as example only.

Configuration diagram

The configuration diagram excerpt shows the required function block, the connections, and the activated selection fields:

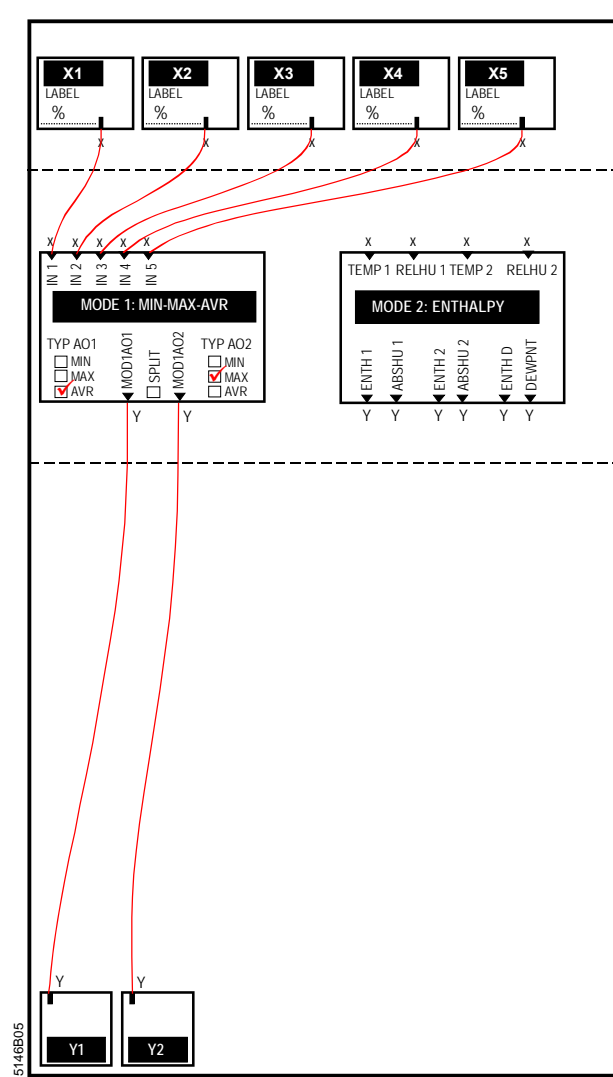

11.3 Configuration diagram

Standard diagram

This configuration diagram generates free configurations for applications of all basic types M, E and D.

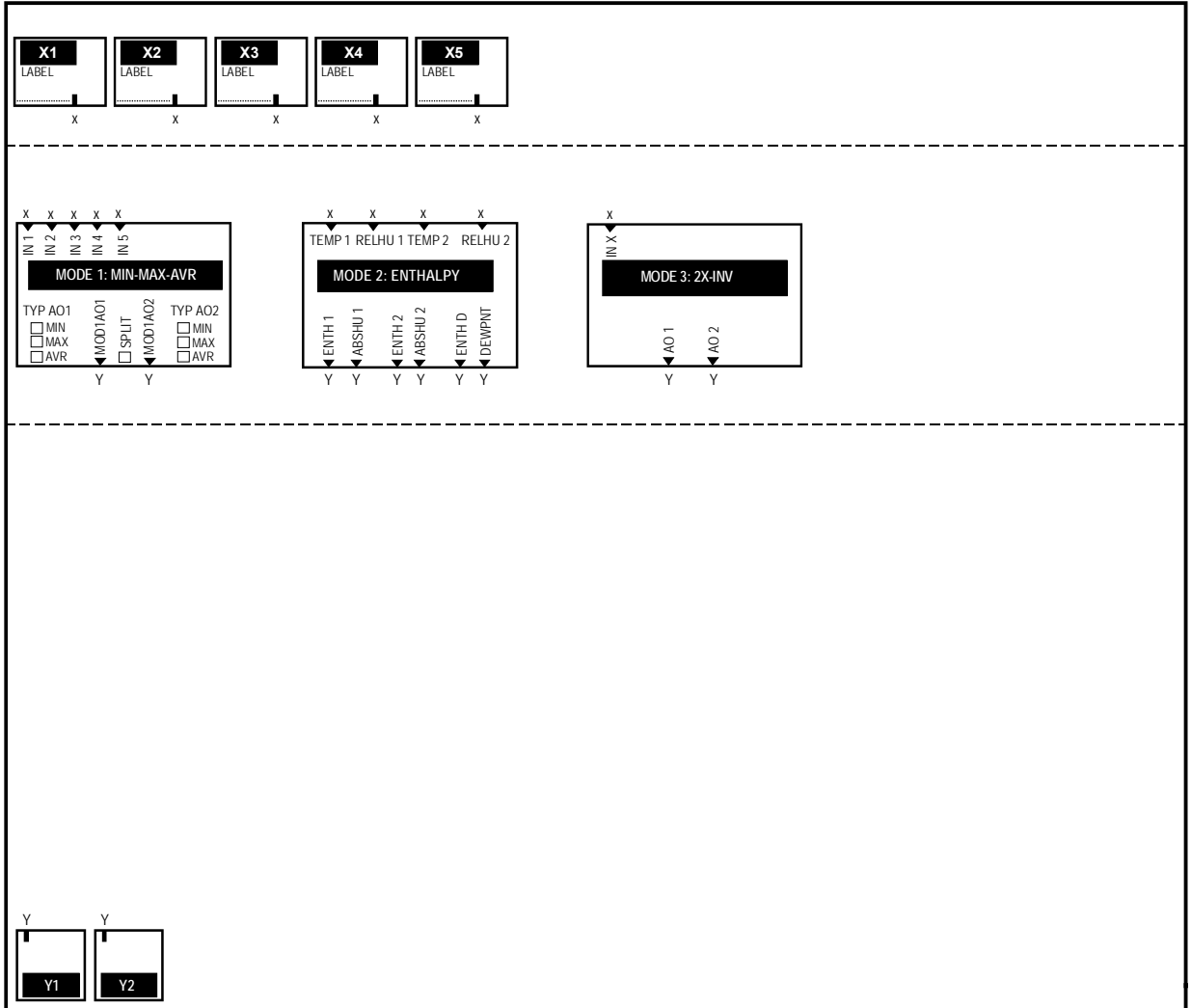

12 Application examples

Introduction

The sections below list the configuration and setting values for simple examples in **free configuration (APPL ID: M)**.

Note

The functions can also be combined if a sufficient number of inputs and output are available. The instructions below contain only the changes for basic type M.

12.1 Multiple use of sensors

Task

Passive temperature sensor LG-Ni 1000 (connected to X1).
Signal conversion to DC 0...10 V = 0...50 °C for further use by Y1.

Configuration

CONF / INPUT X1 / LABEL	TEMP
CONF / 2X-INV / IN X	X1
CONF / 2X-INV / AO 1	Y1

Setting values

PARA / INPUT X1 / TYPE	NI
PARA / 2X-INV / MINVAL1	0
PARA / 2X-INV / MAXVAL1	50
PARA / 2X-INV / MIN POS1	0
PARA / 2X-INV / MAX POS1	100

or:

Configuration

CONF / INPUT X1 / LABEL	TEMP
CONF / MIN-MAX-AVR / IN 1	X1
CONF / MIN-MAX-AVR / SPLIT	NO
CONF / MIN-MAX-AVR / MOD1AO1	Y1

Setting values

PARA / INPUT X1 / TYPE	NI
PARA / MIN-MAX-AVR / MINVAL1	0
PARA / MIN-MAX-AVR / MAXVAL1	50

12.2 Enthalpy and absolute humidity

Task

Passive temperature sensor LG-Ni 1000 connected to X1 and DC 0...10 V signal for relative humidity fed to X2.
Calculate enthalpy (output via Y1) and absolute humidity (output via Y2) as active DC 0...10 V signals.

Configuration

CONF / INPUT X1 / LABEL	TEMP
CONF / INPUT X2 / LABEL	%
CONF / ENTHALPY / TEMP 1	X1
CONF / ENTHALPY / RELHU 1	X2
CONF / ENTHALPY / ENTH 1	Y1
CONF / ENTHALPY / ABSHU 1	Y2

Setting values

PARA / INPUT X1 / TYPE	NI
------------------------	----

12.3 Average and maximum

Task DC 0...10 V signals to X1 and X2.
Output average via Y1 and maximum via Y2 as DC 0...10 V signals.

Configuration

CONF / INPUT X1 / LABEL	%
CONF / INPUT X2 / LABEL	%
CONF / MIN-MAX-AVR / IN 1	X1
CONF / MIN-MAX-AVR / IN 2	X2
CONF / MIN-MAX-AVR / SPLIT	NO
CONF / MIN-MAX-AVR / MOD1AO1	Y1
CONF / MIN-MAX-AVR / TYP AO1	AVR
CONF / MIN-MAX-AVR / MOD1AO2	Y2
CONF / MIN-MAX-AVR / TYP AO2	MAX

12.4 Average from 6 input signals

Task 2 passive temperature sensors LG-Ni 1000 connected to X1 and 1 passive temperature sensor each connected to X2, X3, X4 and X5.
Output average as a DC 0...10 V (0...50 °C) signal at Y1.

Configuration

CONF / INPUT X1 / LABEL	TEMP
CONF / INPUT X2 / LABEL	TEMP
CONF / INPUT X3 / LABEL	TEMP
CONF / INPUT X4 / LABEL	TEMP
CONF / INPUT X5 / LABEL	TEMP
CONF / MIN-MAX-AVR / IN 1	X1
CONF / MIN-MAX-AVR / IN 2	X2
CONF / MIN-MAX-AVR / IN 3	X3
CONF / MIN-MAX-AVR / IN 4	X4
CONF / MIN-MAX-AVR / IN 5	X5
CONF / MIN-MAX-AVR / MOD1AO1	Y1
CONF / MIN-MAX-AVR / TYP AO1	AVR

Setting values

PARA / INPUT X1 / TYPE	2XNI
PARA / INPUT X2 / TYPE	NI
PARA / INPUT X3 / TYPE	NI
PARA / INPUT X4 / TYPE	NI
PARA / INPUT X5 / TYPE	NI
PARA / MIN-MAX-AVR / FACTIN1	2
PARA / MIN-MAX-AVR / MINVAL1	0
PARA / MIN-MAX-AVR / MAXVAL1	50
PARA / MIN-MAX-AVR / MINVAL2	0
PARA / MIN-MAX-AVR / MAXVAL2	50

12.5 Signal converter

Task	DC 0...10 V signal to X1. Invert and output via Y2.	
Configuration	CONF / INPUT X1 / LABEL	%
	CONF / 2X-INV / IN X	X1
	CONF / 2X-INV / AO 2	Y2
Setting value	PARA / 2X-INV / INVERS2	YES

12.6 Adapt signal

Task	DC 0...10 V signal to X1. Adapt to DC 5...7.5 V range and output inverted to Y1.	
Configuration	CONF / INPUT X1 / LABEL	%
	CONF / 2X-INV / IN X	X1
	CONF / 2X-INV / AO 1	Y1
Setting values	PARA / 2X-INV / MINVAL1	0
	PARA / 2X-INV / MAXVAL1	100
	PARA / 2X-INV / MINPOS1	50
	PARA / 2X-INV / MAXPOS1	75
	PARA / 2X-INV / INVERS1	YES

12.7 Signal doubler

Task	DC 0...10 V signal to X1. Subdivide into ranges DC 0...5V (to Y1) and DC 5...10V (to Y2) with output as active signals.	
Configuration	CONF / INPUT X1 / LABEL	%
	CONF / 2X-INV / IN X	X1
	CONF / 2X-INV / AO 1	Y1
	CONF / 2X-INV / AO 2	Y2
Setting values	PARA / 2X-INV / MINVAL1	0
	PARA / 2X-INV / MAXVAL1	50
	PARA / 2X-INV / MINPOS1	0
	PARA / 2X-INV / MAXPOS1	100
	PARA / 2X-INV / INVERS1	NO
	PARA / 2X-INV / MINVAL2	50
	PARA / 2X-INV / MAXVAL2	100
	PARA / 2X-INV / MINPOS2	0
	PARA / 2X-INV / MAXPOS2	100
	PARA / 2X-INV / INVERS2	NO

13 Appendix

13.1 Operating text SEZ220

<i>Operating text</i>	<i>Explanation</i>
°C	Degrees Celsius
°F	Degrees Fahrenheit
0.0	Universal 000.0
0000	Universal 0000
0-10	Active DC 0...10 V = 0...15 °C
2X-INV	Signal doubler-inverter
2xNI	
ABSHU 1	Absolute humidity 1
ABSHU 2	Absolute humidity 2
ALTIT	Elevation above sea level
AO	Modulating output
AO 1	Modulating output 1
AO 2	Modulating output 2
APPL ID	Basic configuration
AVR	Average
AVR 1	Average 1
AVR 2	Average 2
COMMIS	Commissioning
CONF	Extra configuration
CORR	Correction
DEWPNT	Dew point
ENTH 1	Enthalpy 1
ENTH 2	Enthalpy 2
ENTH D	Enthalpy difference
ENTHALPY	Enthalpy processor
FACTIN1	Factor input 1
IN 1	Input 1
IN 2	Input 2
IN 3	Input 3
IN 4	Input 4
IN 5	Input 5
IN X	Preselection external
INFO	Inputs/outputs
INVERS	Inversion
INVERS1	Inversion 1
INVERS2	Inversion 2
LABEL	Input identifier
MAINALM	Main contr var sensor error
MAX	Limitation max
MAX	Maximum
MAX 1	Maximum 1
MAX 2	Maximum 2
MAX VAL	Value high
MAXPOS1	Positioning signal max 1
MAXPOS2	Positioning signal max 2
MAXVAL1	Value high 1

Operating text SEZ220, *continued*

Operating text	Explanation
MAXVAL2	Value high 2
MIN	Minimum
MIN 1	Minimum 1
MIN 2	Minimum 2
MIN VAL	Value low
MIN-MAX-AVR	Min-max average
MINPOS1	Positioning signal min 1
MINPOS2	Positioning signal min 2
MINVAL1	Value low 1
MINVAL2	Value low 2
MOD1AO1	Min-max average output 1
MOD1AO2	Min-max average output 2
MODE	Operating mode
NI	Passive Ni1000
NO	No
OHM	
OPEN	Open
PARA	Settings
PASS	Password level
PASSWRD	Enter password
PT	
RELHU 1	Relative humidity input 1
RELHU 2	Relative humidity input 2
SETTING	Settings
SPLIT	Inputs segregated
START OK	Caution! Plant starts
STATUS	Device state
STOP OK	Caution! Plant stops
SW-VERS	Software version
TEMP 1	Temperature input 1
TEMP 2	Temperature input 2
TEST	Wiring test
TYP AO1	Function type output 1
TYP AO2	Function type output 2
TYPE	Type
UNIT	Unit
USER	User level
WIRING TEST	Wiring test
YES	Yes

Index

2		
2X-INV, function block		
Error handling.....	33	
Example of MIN POS / MAX POS	33	
Functions.....	31	
Notes on wiring test.....	33	
A		
Application example		
Adapt signal.....	42	
Average and maximum	41	
Average from 6 input signals.....	41	
Enthalpy and absolute humidity	40	
Signal converter	42	
Signal doubler	42	
Application examples		
Multiple use of sensors	40	
B		
Basic types M, E, D	17	
C		
Change operating level.....	12	
Configuration		
Configuration diagram.....	39	
Configuration principle	37	
Standard application example	38	
D		
Data point, term	12	
E		
ENTHALPY, function block		
Error handling.....	30	
Functions.....	28	
Output signal value range	28	
F		
Fault list	34	
I		
inputs X1...X5		
measuring range temperature	21	
Inputs X1...X5		
identifier	21	
Setting value CORR	21	
Setting value TYPE.....	21	
M		
Menu navigation, example	15	
Menu structure	14	
MIN-MAX-AVR, function block		
Assignment rules with SPLIT	26	
Assignment rules without SPLIT.....	26	
Error handling	27	
Functions	25	
Note on MIN x display.....	27	
Parameter FACTIN1	25	
O		
Operating text, addendum.....	43	
S		
Safety notes	9, 16	
Select access level.....	13	
Select basic type	17	
Settings, general		
Temperature unit.....	18	
View software version.....	18	
SEZ220, device		
Connection rules.....	35	
Connection terminals	36	
Connections and functions	7	
Device combinations.....	8	
Scope of delivery	7	
Symbols on the display	11	
W		
Wiring test	19	

Siemens Switzerland Ltd
Building Technologies Group
International Headquarters
Gubelstrasse 22
CH-6301 Zug
Tel. +41 41-724 24 24
Fax +41 41-724 35 22
www.siemens.com/sbt

© 2004-2008 Siemens Switzerland Ltd
Subject to change