



Room Temperature Controller with LCD

RDU20

for heating and cooling systems

Modulating PI control or ON/OFF control selectable
Control depending on the room or the return air temperature
Three point output for heating or cooling
Automatic heating / cooling changeover
Operating modes: normal and energy saving (or off)
Operating mode changeover input for remote control
Selectable installation and control parameters
Display of room temperature or setpoint selectable
Minimum and maximum setpoint limitation
Operating voltage AC 230 V

Use

Control of the room temperature in individual rooms of ventilation or air conditioning plants that are heated or cooled.

For the control of the following pieces of equipment:

- Three-position valve actuators
- Three-position damper actuators

The controller acquires the room temperature with its integrated sensor or external room temperature sensor (QAA32) – if used – via a remote return air temperature sensor (QAH11.1) and maintains the setpoint by delivering 3-position control commands to the actuator. The controller provides PI control or ON/OFF control (selectable via DIP switch no 2). The proportional band (or switching differential) in heating mode is 2 K and in cooling mode 1 K (adjustable). The integral action time is 5 minutes (adjustable).

Heating mode

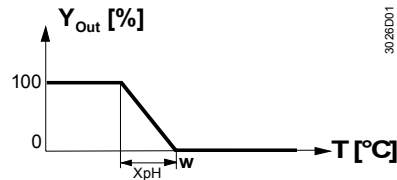

Cooling mode

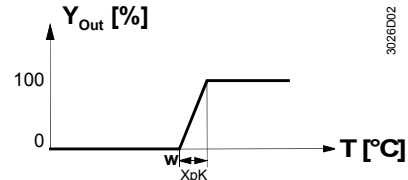

- | | | | |
|-----|-----------------------------|------------------|---------------------------|
| T | Room temperature | w | Room temperature setpoint |
| XpH | Proportional band "Heating" | Y _{Out} | Manipulated variable |
| XpK | Proportional band "Cooling" | | |

Note 1: The diagrams only show the proportional part of the PI controller
 Note 2: If ON/OFF control is selected, Xp becomes the switching differential

Automatic changeover

The water or air temperature acquired by the changeover sensor (QAH11.1) is used by the controller to automatically switch from heating to cooling mode, or vice versa. When the temperature lies above 28 °C (adjustable), the controller switches to heating mode, below 16 °C (adjustable) it switches to cooling mode. If, immediately after switching on, the temperature lies between the 2 changeover points, the controller will start in heating mode. The temperature is measured at half-minute intervals and the operational status updated. The value of the current temperature reading and the mode can be visualized temporary by selecting parameter P14.

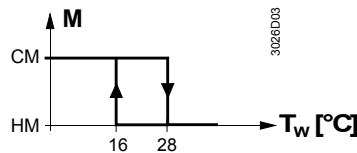

- | | |
|----------------|--------------------|
| CM | Cooling mode |
| HM | Heating mode |
| T _w | Medium temperature |
| M | Operating mode |

In systems without automatic changeover, the temperature sensor can be replaced by an external switch (suited for mains voltage) for manual changeover. In systems with continuous heating mode, no sensor will be connected to the controller's input. With continuous cooling mode, the controller input must be bridged.

Three-position control signal

Outputs Y1 = opening, Y2 closing and N = neutral are used to drive three-position actuators with a maximum running time of 150 seconds from the fully closed to the fully open position.

- 1 When commissioning the controller, a closing signal of the actuator running time (parameter P11) + 20% seconds is delivered to ensure the actuator will be fully closed and synchronized with the control algorithm. This synchronization is not active when ON/OFF control is selected (DIP switch no 2).
- 2 When the actuator has reached the position calculated by the controller, a waiting time of 30 seconds is observed in order to stabilize the outputs.
- 3 The control outputs carry AC 230 V.



Return air temperature

The RDU20 provides control either depending on the measured room temperature or depending on the return air temperature. The return air temperature measurement overrides the internal measurement automatically if a QAH11.1 cable temperature sensor is connected to input B1-M. Parameter P12 shows which temperature sensor is currently active.

Display

If the DIP switch no 1 is set to ON (factory setting) the controller displays the measured room or return air temperature (unless parameter or setpoints are temporarily selected). If the DIP switch is set to OFF, the controller displays the active setpoint (normal operation or energy saving mode). In this case the value of the current temperature reading can only be visualized temporarily by selecting parameter P13.

Operating modes

Normal operation

Heating or cooling mode with automatic changeover. The controller maintains the adjusted setpoint.

Energy saving mode

A changeover switch can be connected to status input D1-GND. When the switch closes (caused by an open window, for instance), the operating mode will change from normal operation to energy saving mode. In this operating mode, the setpoints of heating or cooling are maintained (setting of control parameters P01 and P02). If the energy saving mode setpoints are set to OFF, the controller is OFF when the switch closes its contact. Note that in energy saving mode the normal operation setpoint is displayed if selected, but it cannot be modified.

The operating action of the switch is N.O.

Setting the control parameters

A number of control parameters can be set to optimise the control performance. These parameters can also be set during operation without opening the unit. In the event of a power failure, all control parameters set will be maintained.

Settings

The parameters can be changed as follows:

1. Press buttons + and – simultaneously for a minimum of 3 seconds and a maximum of 5 seconds. Release them and press button + again for approximately 3 seconds until the display shows “P01”.
2. Select the required parameter by repeatedly pressing buttons + and – :

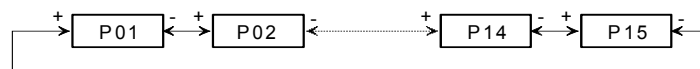

3. By pressing buttons + and – simultaneously, the current value of the selected parameter appears, which can be changed by repeatedly pressing buttons + and –.
4. By pressing buttons + and – simultaneously again or after 5 seconds after the last press of a button (not valid for P15), the last parameter will be displayed again.
5. If you wish to display and change additional parameters, repeat steps 3 through 5.
6. 10 seconds after the last display or setting, all changes will be stored and the controller returns to normal operation.

Control parameters

Parameter	Meaning	Setting range	Factory setting
P01	Setpoint of heating in energy saving mode (operating mode changeover switch activated)	OFF, 5...18 °C (in increments of 0.5 K)	16 °C
P02	Setpoint of cooling in energy saving mode (operating mode changeover switch activated)	OFF, 24...35 °C (in increments of 0.5 K)	28 °C
P03	Minimum setpoint limitation in normal mode	5...20 °C (in increments of 0.5 K)	5 °C
P04	Maximum setpoint limitation in normal mode	21...35 °C (in increments of 0.5 K)	35 °C
P05	Heat-cool changeover switching point cooling	10...25 °C (in increments of 0.5 K)	16 °C
P06	Heat-cool changeover switching point heating	27...40 °C (in increments of 0.5 K)	28 °C
P07	Sensor calibration	-3...+3 K (in increments of 0.5 K)	0 K
P08	P-band / switching differential in heating mode	0.5...+4 K (in increments of 0.5 K)	2 K
P09	P-band / switching differential in cooling mode	0.5...+4 K (in increments of 0.5 K)	1 K
P10	Integration time (only with modulating PI control, DIP switch no. 2 is set to ON)	1...10 min. (in increments of 1 min.)	5 min.
P11	Actuator running time (only with modulating PI control, DIP switch no. 2 is set to ON)	50...150 s (in increments of 10 s)	150 s
P12	Active temperature sensor (no setting, display only)	1: room temperature sensor active 2: return air temperature sensor active	-
P13	Value of current room temperature reading (no setting, display only)	0...49 °C = current temperature value (below and above this range???)	-
P14	Value of current heat-cool changeover temperature reading including indication of current mode (⚙️, 🌡️) (no setting, display only)	100 = input open (no sensor connected, heating mode (🔥)) 0...49 °C = current temperature value 00 = input bridged, cooling mode (❄️)	-
P15	Test mode for checking the actuator direction (note that this parameter can be quit only if the setting is back at “---” and by pressing buttons + and – simultaneously)	“---” = no signal on outputs Y1 and Y2 OPE = output Y1 forced open CLO = output Y2 forced open	---

Equipment combinations

Type of unit	Type reference	Data sheet
Temperature sensor	QAH11.1	1840
Room sensor	QAA32	1747
Changeover mounting kit for pipes	ARG86.3	1840
Changeover mounting kit for ducts	ARG22.2	1831
Motonic actuator (radiator valve)	SSA31...	4893
Motonic actuator (small valve 2,5 mm)	SSP31...	4864
Motonic actuator (small valve 5,5 mm)	SSB31...	4891
Motonic actuator (valve 5,5 mm)	SSC31...	4895
Motonic actuator (valve 5,5 mm)	SQS35...	4573
3-Point damper actuators	GDB33... / GLB33...	4634
	GBB33...	4626
	GIB33...	4626
	GXD331.1A	4622
Residential damper actuator*		

*use with ON/OFF control algorithm, DIP switch no 2 set to OFF

Mechanical design

The unit consists of 2 parts:

- A plastic housing which accommodates the electronics, the operating elements and the built-in room temperature sensor
- A baseplate



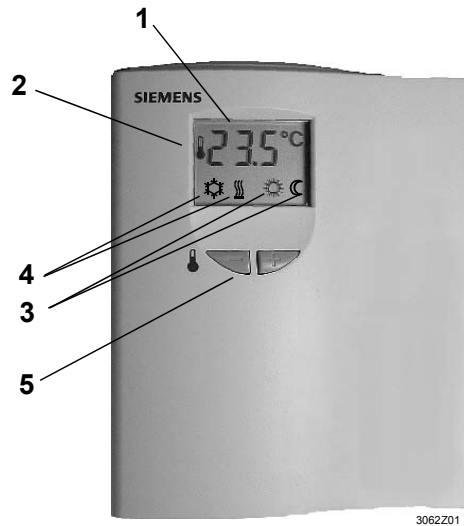

The housing engages in the baseplate and is secured with two screws.

The baseplate carries the screw terminals. The DIP switches are located at the rear of the housing.

Setting and operating elements



Legend

- 1 Display of the room or return air temperature, setpoints and control parameters
- 2  Symbol used when displaying the current room temperature
- 3  Normal operation
 Energy saving mode (if no setpoint is active (= parameter set to zero), no symbol appears).
- 4  Cooling valve or damper open
 Heating valve or damper open
- 5 Buttons for adjusting the setpoints and the control parameters

DIP switch

DIP switch no.	Meaning	Position ON (factory setting)	Position OFF
1	Display of temperature or setpoint	Room (or return air) temperature display	Setpoint display
2	Control algorithm	Modulating PI control	ON/OFF control (in conjunction with GXD331.1A actuator)

Accessories

Description	Type reference
Adapter plate 120 x 120 mm for 4" x 4" conduit boxes	ARG70
Adapter plate 96 x 120 mm for 2" x 4" conduit boxes	ARG70.1
Adapter plate for surface wiring 112x130 mm	ARG70.2

Mounting, installation and commissioning notes

In systems without automatic changeover, the temperature sensor can be replaced by an external switch (suited for mains voltage) for manual changeover.

In systems with continuous heating mode, no sensor will be connected to the controller's input.

With continuous cooling mode, the controller input (B2-M) must be bridged.

Mounting location: on a wall of the room to be heated or cooled. Not in niches or bookshelves, not behind curtains, above or near heat sources and not exposed to direct solar radiation. Mounting height is about 1.5 m above the floor. The connecting wires can be run to the controller from a recessed conduit box.

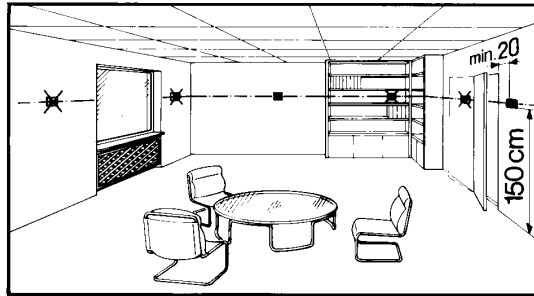

Check the setting of the DIP switches and change, if required. After applying power, the controller makes a reset during which all LCD segments flash, indicating that the reset has been made correctly. This takes about 3 seconds. Then, the controller is ready to operate.

Test mode: Parameter P15 helps to check the correct functioning of the actuator and its direction: Select parameter P15 and press + to change display to "OPE", now Y1 is active (open signal). Press + again to change display to "CLO", now Y2 is active (close signal). Press + again to change display to "---" and then press buttons + and - simultaneously to quit the test mode.

If the modulating PI control algorithm is selected (DIP switch no 2 ON, factory setting): Before the controller starts its control action (after power on or after quitting the test mode), it performs a 3-position synchronization of the actuator. As a result, a closing signal of the actuator running time (parameter P11) + 20% seconds is delivered to ensure the actuator will be fully closed and synchronized with the control algorithm. Then, the controller will be ready to operate.

- Prior to fitting the changeover sensor on a pipe, thermal conductive paste must be applied to the location on the pipe where the sensor is placed
- The cables used must satisfy the insulation requirements with regard to mains potential
- Sensor inputs B1-M and B2-M carry mains potential. If the sensor's cables must be extended, they must be suited for mains voltage





The controller is supplied with Mounting Instructions.



Calibrating the sensor

If the room temperature displayed by the controller does not agree with the room temperature effectively measured, the temperature sensor can be recalibrated. In that case, parameter P07 must be changed.

Technical data

⚠ Power supply	Operating voltage	AC 230 V +10/-15 %	
	Frequency	50/60 Hz	
	Power consumption	max. 6 VA	
	Control outputs Y1, Y2 – N	AC 230 V, max. 5 (3) A	
	Return air temperature input B1-M and changeover temperature input B2-M	QAH11.1, safety class II NTC resistor 3 kΩ at 25 °C	
	Status input D1 and GND		
	Contact sensing	SELV DC 6-15 V / 3-6 mA	
	Insulation against mains	4 kV, reinforced insulation	
	Operating action	N.O.	
	Perm. cable length with copper cable 1.5 mm ² for connection to terminals B1, B2 and D1	80 m	
Operational data	Setpoint setting range	5...35 °C	
	Control deviation at 25 °C	max. ±0.5 K	
	Setpoint in normal operation, adjustable	20 °C	
	P-band in heating mode, adjustable	2 K	
	P-band in cooling mode, adjustable	1 K	
	Integral action time, adjustable	5 minutes	
	Setpoint «Energy saving mode  », heating (adjustable)	16 °C	
	Setpoint «Energy saving mode  », cooling (adjustable)	28 °C	
	Environmental conditions	Operation	to IEC 721-3-3
		Climatic conditions	class 3 K5
Temperature		0...+50 °C	
Humidity		<95 % r.h.	
Transport		to IEC 721-3-2	
Climatic conditions		class 2 K3	
Temperature		-25...+70 °C	
Humidity		<95 % r.h.	
Mechanical conditions		class 2M2	
Storage		to IEC 721-3-1	
Climatic conditions	class 1 K3		
Temperature	-25...+70 °C		
Humidity	<95 % r.h.		
Norms and standards	 conformity to		
	EMC directive	89/336/EEC	
	Low voltage directive	73/23/EEC	
	 N474 C-Tick conformity to	AS/NSZ 4251.1:1994	
	EMC emission standard		
	Product standards		
	Automatic electrical controls for household and similar use	EN 60 730 – 1	
	Special requirements on temperature-dependent controls	EN 60 730 – 2 – 9	
	Electromagnetic compatibility		
	Emissions	EN 50 081-1	
Immunity	EN 50 082-1		
Devices of safety class	II to EN 60 730		
Pollution class	normal		

General

Degree of protection of housing	IP 30 to EN 60 529
Connection terminals	solid wires or prepared stranded wires 2 x 0.4-1.5 mm ² or 1 x 2.5 mm ²
Weight	0.225 kg
Colour of housing front	white, NCS S 0502-G (RAL9003)

Connection diagram

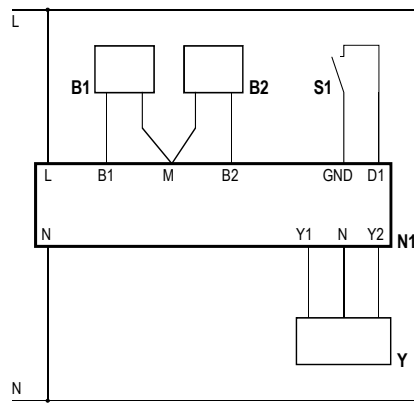

- B1 Return air temperature sensor
- B2 Heating-cooling changeover sensor
- N1 Room temperature controller
- S1 External operating mode changeover switch
- Y 3-point valve actuator
- Y1 Control output "Open valve", AC 230 V
- Y2 Control output "Close valve", AC 230 V

Dimensions

Controller

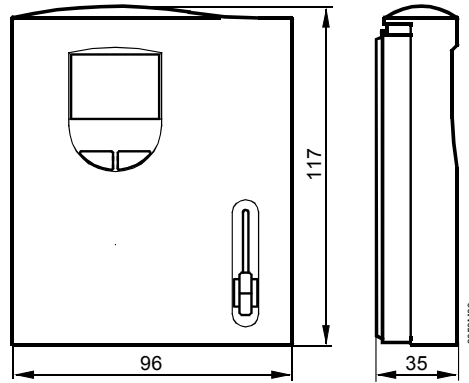

Baseplate

