

SIEMENS

Landis & Staefa Division

AV62

(SCS 2T...)

(KWC)

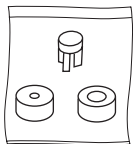

35732

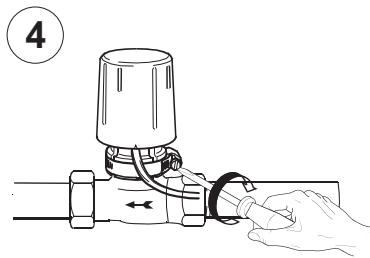
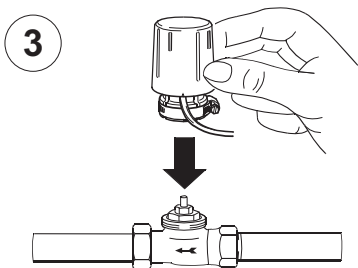
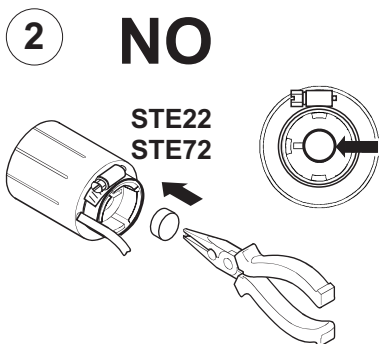
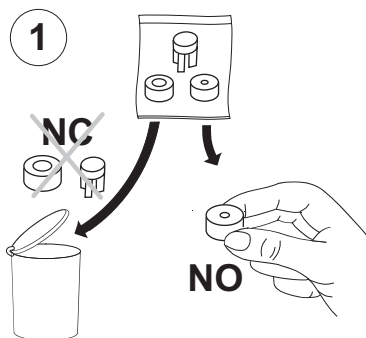

NO → NC

5

...

9

NC

5

III

II

I

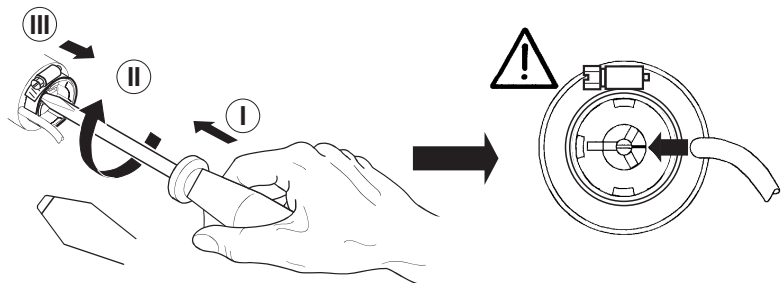

6



NC

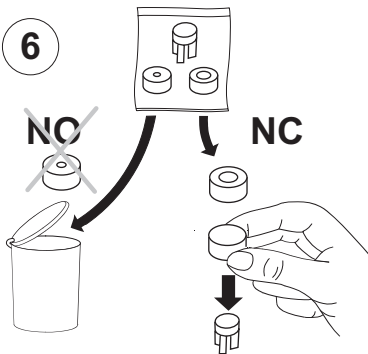

7

STE22
STE72

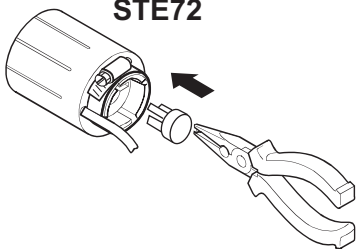

8

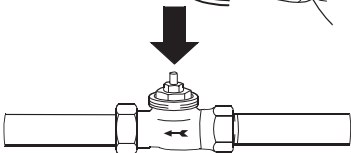
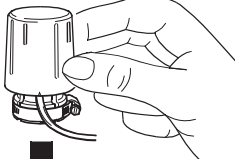

9

