

Installation

Place of installation

- In a dry room, e.g. the heat exchanger room
- Mounting choices:
 - In a compact station
 - In a control panel (in the front, on the inner wall, or on a DIN mounting rail)
 - In the sloping front of a control desk

Permissible ambient temperature: 0...50 °C

Electrical installation

- Local regulations for electrical installations must be complied with
- Cable tension relief must be ensured
- The cables from the controller to the actuators and pumps carry mains voltage
- The cables to the sensors should not be run parallel to mains carrying cable (safety class II to EN 60730!)

Permissible cable lengths

- For all sensors:

Copper cable 0.6 mm dia.	20 m max.
Copper cable 1.0 mm ²	80 m max.
Copper cable 1.5 mm ²	120 m max.
- For room units:

Copper cable 0.6 mm dia.	37 m max.
Copper cable ≥0.8 mm dia.	75 m max.

Mounting and wiring the base

Wall mounting

1. Separate base from the controller
2. Hold base against the wall. Marking "TOP" must be at the top!
3. Mark fixing holes on the wall
4. Drill holes
5. If required, knock out holes on the base for cable entry glands
6. Screw base to the wall
7. Wire up base

DIN rail mounting

1. Fit rail
2. Separate base from the controller
3. If required, knock out holes on the base for cable entry glands
4. Fit base to the rail. Marking "TOP" must be at the top!
5. If required, secure base (depending on the type of rail used)
6. Wire up base

Flush panel mounting

- Maximum thickness: 3 mm
- Panel cutout required: 92 x 138 mm

1. Separate base from the controller
2. If required, knock out holes on the base for cable entry glands
3. Insert base in the panel cutout from behind until stop is reached. Marking "TOP" must be at the top!
4. Push lateral tongues behind the front panel (refer to illustration below)

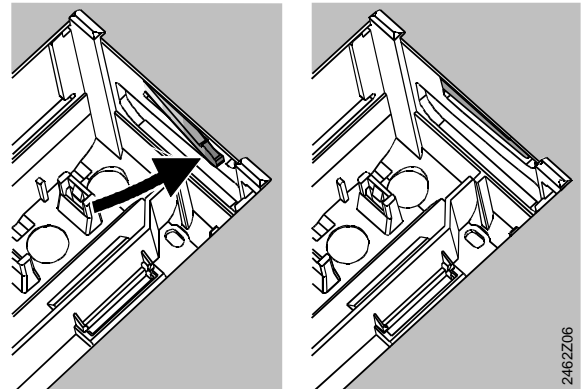

Wrong

Correct

Place tongues on both sides correctly – they may not be located inside the cutout!

5. Wire up base. Make sure the cable lengths are such that there is sufficient space to open the control panel door

Securing the controller to the base

1. Ensure correct position and location of levers by turning the fixing screws (refer to illustration on the lateral wall of the unit)

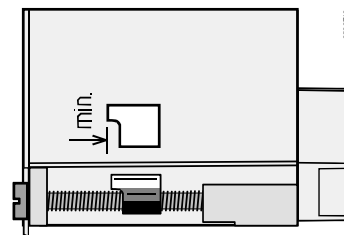

2. Insert controller in the base until stop is reached. Marking "TOP" must be at the top!
3. Tighten fixing screws alternately

Commissioning

Preparatory checks





1. DO NOT switch on power supply yet
2. Check wiring according to the plant connection diagram
3. Check each motorized valve: see if
 - it is correctly installed (observe direction of flow indicated on the valve body)
 - the manual lever is disengaged

4. Note with underfloor and ceiling heating systems!



The limit thermostat must be set to the correct value. During the functional test, the flow temperature may not exceed the maximum permissible level (usually 55 °C). If it does, proceed immediately as follows:

- Either close the valve manually, or
 - Switch off the pump, or
 - Close the pump isolating valve
5. Switch on power supply. The display must show the time of day. If not, the reason may be one of the following:
- No mains voltage present
 - Main fuse defective
 - Mains isolator or main switch not set to ON
6. If one of the operating mode buttons flashes, a room unit overrides the controller. Select operating mode  on the room unit

General information about operation



- Setting elements for commissioning:
 - Nominal room temperature setpoint: with the setting knob
 - Other variables: in the display, where one operating line is assigned to each setting
- Buttons for selecting and readjusting the values:
 -  To select the next operating line below
 -  To select the next operating line above
 -  To decrease the displayed value
 -  To increase the displayed value
- Adopting a setting value:



The setting value is adopted by selecting the next operating line (or by pressing one of the operating mode buttons)
- Entering --. / --: / --- (deactivating a function):

Keep  or  depressed until the required display appears
- Block jump function:

To select a single operating line quickly, two button

combinations can be used:

Keep  depressed and press  to select the next line block above



Keep  depressed and press  to select the next line block below

Setting procedure

 Enter all adjusted values in the tables provided!

1. Make settings on the "End-user" level (operating lines 1...50)
2. Configure plant type on operating lines 51... 55
3. Make the relevant settings in the parameter list below. All functions and operating lines configured for the type of plant are activated and adjustable. All operating lines that are not required are locked.
4. Make settings on the "Heating engineer's" level (operating lines 56...150).
5. Make settings on the "Locking functions" level (operating lines 151...191)

Commissioning and functional check

- Specific operating lines for the functional check:
 - 141 = sensor test
 - 142 = relay test
 - 149 = reset of service settings
- If **Er** (ERROR) appears in the display: interrogate operating line 50 to pinpoint error
- If no line selection button has been pressed for eight minutes, or if one of the operating mode buttons is pressed (controller in the non-operated status), setting buttons  and  can be used to prompt all actual values and the time of day. The actual values are presented like those on operating line 141.

Setting elements

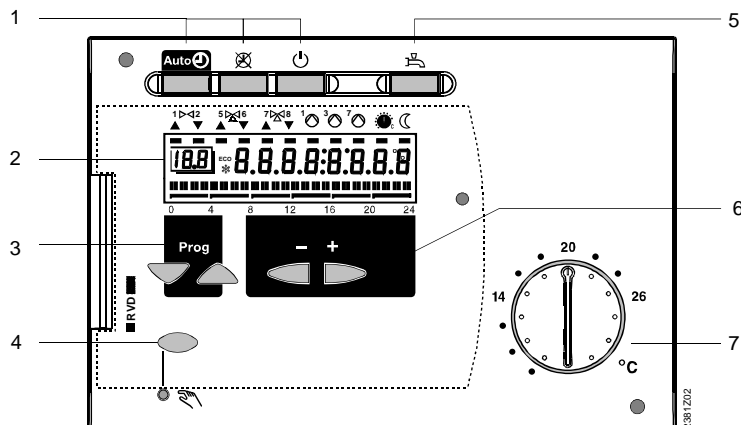

- 1 Operating mode buttons
- 2 Display
- 3 Buttons for selecting operating lines
- 4 Button for manual operation ON / OFF
- 5 Button for d.h.w. heating ON / OFF
- 6 Buttons for making readjustments of values
- 7 Setting knob for nominal room temperature setpoint

Connection diagrams

Low voltage side

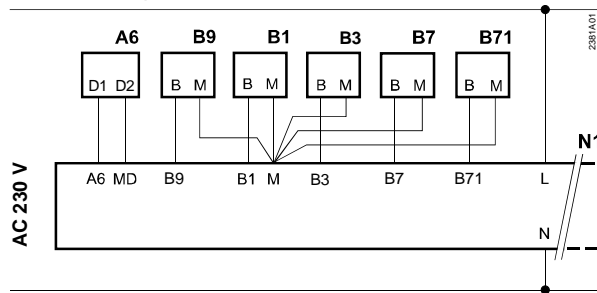

RVD110

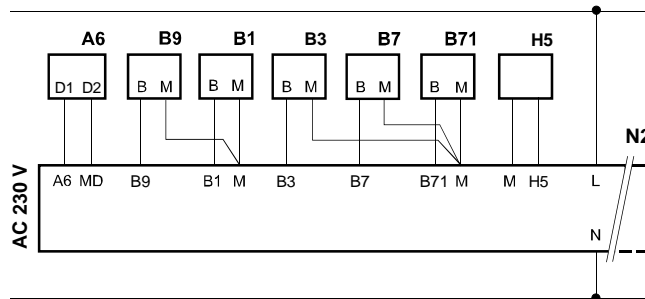

RVD130

Mains voltage side

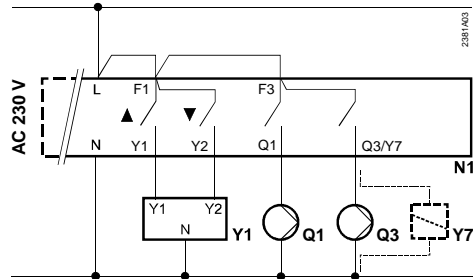

RVD110 (plant types 1, 2 and 3)

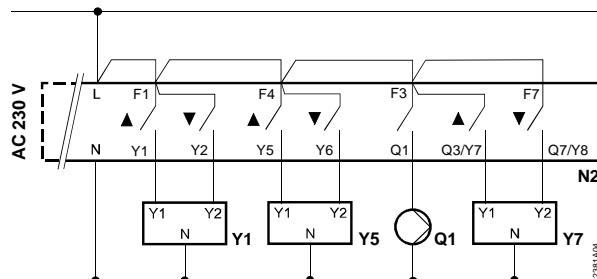

RVD130 (plant type 5)
Three actuators and one pump

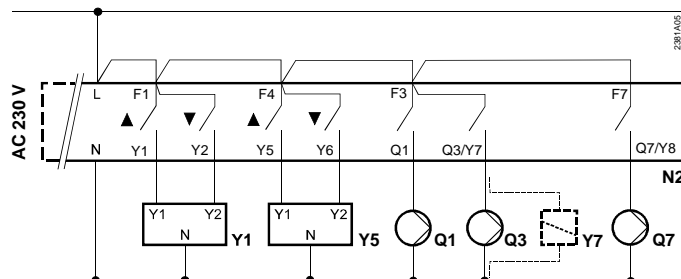

RVD130 (plant types 1, 2, 3, 4, 6, 7 and 8)
Two actuators and three pumps or two pumps and one changeover valve

A6 Room unit
 B1 Flow temperature sensor
 B3 D.h.w. temperature sensor
 B7 Primary return temperature sensor
 B71 Universal sensor according to plant type
 B9 Outside sensor
 F1 D.h.w. thermostat
 H5 Flow switch







N1 Controller RVD110
 N2 Controller RVD130
 Q1 Heating circuit pump
 Q3 D.h.w. charging pump
 Q7 Circulating pump
 Y1 Actuator of two-port valve in the primary return
 Y5 Actuator of mixing valve or of two-port valve according to plant type
 Y7 Actuator of changeover valve or of mixing valve according to plant type

Parameter list

Line	Function, display	Default	Range	Setting	Explanations, notes and tips
------	-------------------	---------	-------	---------	------------------------------



Settings on the „End-user“ level

Press  or  to activate the “End-user“ level

Line	Function, display	Default	Range	Setting	Explanations, notes and tips
1	Current nominal room temperature setpoint		Display function		Including room unit
2	Reduced room temperature setpoint	14 °C	Variable* °C	* From nominal setpoint to frost protection setpoint
3	Frost protection / holiday mode setpoint	8 °C	8 °C ... variable* °C	* From 8 to reduced setpoint. Holiday setting only with room unit QAW70
5	Heating curve slope	15	2.5...40	Effective slope is ten times smaller
6	Weekday, for entering the heating program	Current weekday	1...7, 1-7		1 = Monday, 2 = Tuesday, etc. 1-7 = entire week
7	Heating period 1 start	6:00	00:00...24:00 :	Switch. program for heating circuit --:-- = period inactive
8	Heating period 1 end	22:00	00:00...24:00 :	Switch. program for heating circuit --:-- = period inactive
9	Heating period 2 start	--:--	00:00...24:00 :	Switch. program for heating circuit --:-- = period inactive
10	Heating period 2 end	--:--	00:00...24:00 :	Switch. program for heating circuit --:-- = period inactive
11	Heating period 3 start	--:--	00:00...24:00 :	Switch. program for heating circuit --:-- = period inactive
12	Heating period 3 end	--:--	00:00...24:00 :	Switch. program for heating circuit --:-- = period inactive
13	Time of day	Undefined	00:00...23:59		
14	Weekday	--:--	1...7		1 = Monday, 2 = Tuesday, etc.
15	Date	01.01	01.01...31.12.		Day.Month
16	Year	2004	1995...2094		
17	Weekday, for entering the d.h.w. program	Current weekday	1...7, 1-7		1 = Monday, 2 = Tuesday, etc. 1-7 = entire week
18	Release period 1 start	6:00	00:00...24:00 :	Switching program for d.h.w. --:-- = period inactive
19	Release period 1 end	22:00	00:00...24:00 :	Switching program for d.h.w. --:-- = period inactive
20	Release period 2 start	--:--	00:00...24:00 :	Switching program for d.h.w. --:-- = period inactive
21	Release period 2 end	--:--	00:00...24:00 :	Switching program for d.h.w. --:-- = period inactive
22	Release period 3 start	--:--	00:00...24:00 :	Switching program for d.h.w. --:-- = period inactive
23	Release period 3 end	--:--	00:00...24:00 :	Switching program for d.h.w. --:-- = period inactive
24	Room temperature (terminal A6)		Display function		
25	Outside temperature		Display function		Press  and  for 3 s: actual outside temperature will be adopted as the attenuated outside temperature
26	D.h.w. temperature		Display function		
27	Flow temperature heating circuit		Display function		Keep  or  depressed: current setpoint is displayed
41	Setpoint d.h.w. temperature NORMAL	55 °C	variabel °C	
42	Setpoint d.h.w. temperature REDUCED	40 °C	8...setpoint NORMAL °C	
49	Reset of operating lines 2...12, 17...23 and 41, 42				Press  and  until display changes: 0 (flashing) = normal status 1 = reset to factory settings completed

50	Display of faults	Display function	10 = fault outside sensor 30 = fault flow temperature sensor 40 = fault return temperature sensor (primary side) 42 = fault return temperature sensor (secondary side) 50 = fault d.h.w. temperature sensor 61 = fault room unit 62 = connected unit shows wrong identification 86 = short-circuit on room unit bus (PPS)
----	-------------------	-------------------------	--

Settings on the “Heating engineer’s” level

Press  and  simultaneously for 3 seconds, thus activating the “Heating engineer’s” level for configuring the plant type and for setting the plant-related variables. The “End-user” level remains activated.

Configuration of plant

The required plant type must be configured on operating lines 51...55. This activates all functions and operating lines required for the particular type of plant, which can then be set.

Ignore the other types of plant!

Line	Function, display	Default	Range	Setting	Explanations, notes and tips		
51	Plant type	1	1...3 or 1...8	RVD110: range 1...3 RVD130: range 1...8 For diagram, refer to the following section		
52	Space heating present	1	0 / 1	0 = no space heating present 1 = space heating present		
53	Universal sensor connected to B71	1	0 / 1	0 = secondary return temperature sensor 1 = d.h.w. temperature sensor		
54	Flow switch present / circulating pump present (heat losses are compensated)	0	0...3	<i>Flow switch present</i>	<i>Circulating pump present</i>	
					0	no	insignificant (heat losses fully compensated [100 %])
					1	yes	no
					2	yes	yes, heat losses partly compensated (80 %)
55	Return flow of circulating pump	0	0...2	0 = d.h.w. storage tank / no circulating pump	1 = heat exchanger, heat losses partly compensated (80 %)	
					2 = heat exchanger, heat losses fully compensated (100 %)		
56	Periodic pump run (pump kick)	1	0 / 1	0 = no periodic pump run 1 = weekly pump run enabled		
57	Winter- / summertime changeover	25.03	01.01. ...31.12	Setting: earliest possible changeover date		
58	Summer- / wintertime changeover	25.10	01.01. . 31.12	Setting: earliest possible changeover date		

Plant types

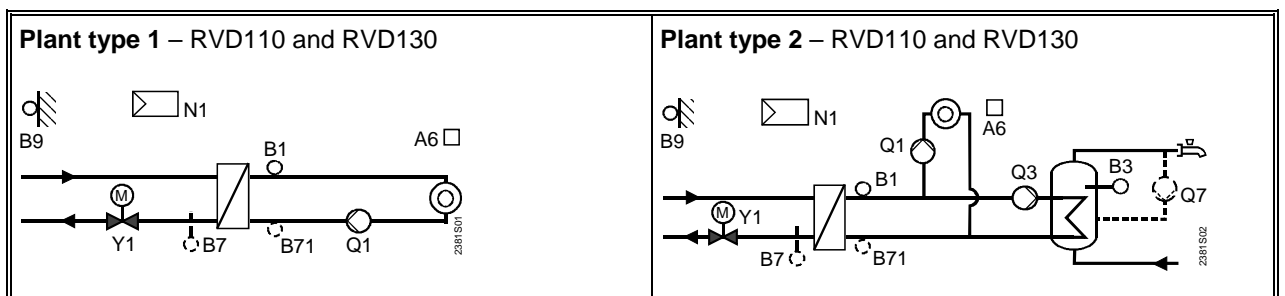

Plant type 3 – RVD110 and RVD130

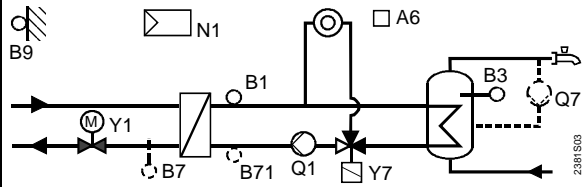

Plant type 4 – only RVD130

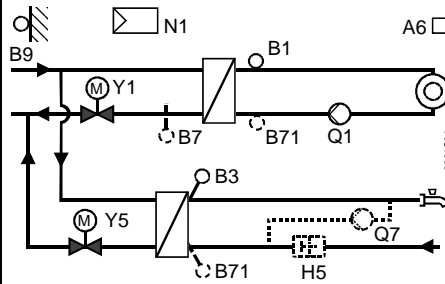

Plant type 5 – only RVD130

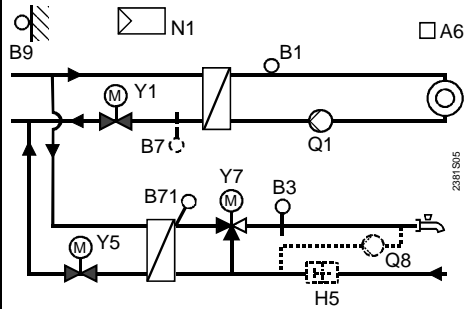

Plant type 6 – only RVD130

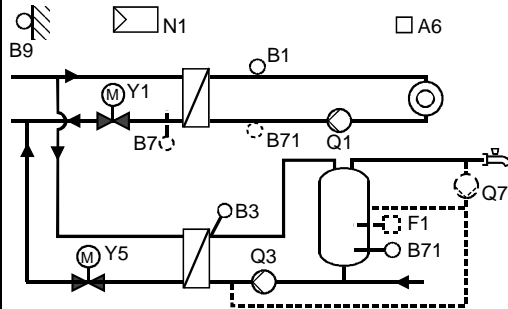

Plant type 7 – only RVD130

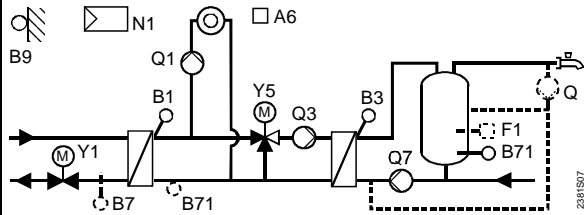

Plant type 8 – only RVD130

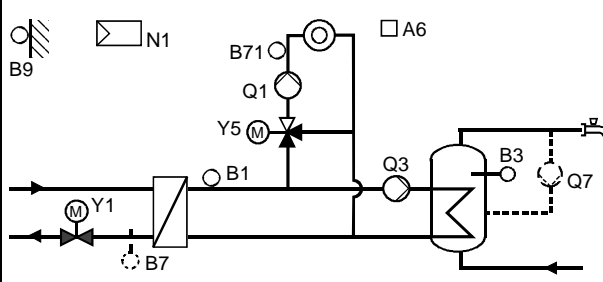

- | | | | |
|-----|---|----|---|
| A6 | Room unit | N1 | Controller |
| B1 | Flow temperature sensor (controlled variable) | Q1 | Heating circuit pump |
| B3 | D.h.w. temperature sensor | Q3 | Charging pump |
| B7 | Primary return temperature sensor | Q7 | Circulating pump controlled by controller (only RVD130) |
| B71 | Universal sensor according to plant type | Q | Externally controlled circulating pump |
| B9 | Outside sensor | Y1 | Two-port valve in the primary return |
| F1 | D.h.w. thermostat | Y5 | Actuator of mixing valve or of two-port valve according to plant type |
| H5 | Flow switch | Y7 | Actuator of changeover valve or of mixing valve according to plant type |

Heating slope chart

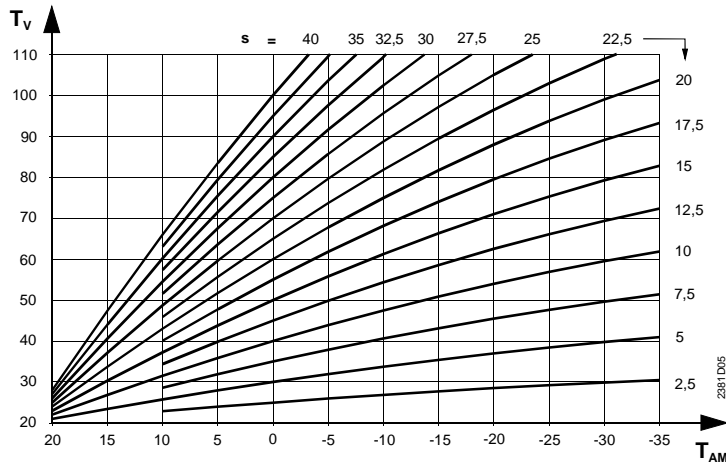

- s Slope
 T_{AM} Composite outside temperature
 T_V Flow temperature

Line	Function, display	Default	Range	Setting	Explanations, notes and tips
------	-------------------	---------	-------	---------	------------------------------

Block „Space heating“

61	Heating limit (ECO)	-3 K	---, -10...+10 K K	--- = function deactivated
62	Building structure	1	0 / 1	0 = heavy 1 = light
63	Quick setback without room temperature sensor	1	0...15	0 = no quick setback 1 = min. setback time 15 = max. setback time
66	Adaptation of heating curve	0	0 / 1	0 = no adaptation 1 = adaptation
69	Heat gains	0 K	-2...+4 K K	Setting in K room temperature
70	Room temperature influence (gain factor)	10	0...20	Function can be provided only with room temperature sensor
71	Parallel displacement of heating curve	0.0 K	-4.5...+4.5 K K	Setting in K room temperature
72	Overrun time heating circuit pump	4 min	0...40 min min	0 = no pump overrun
73	Frost protection for the plant	1	0 / 1	0 = no frost protection for the plant 1 = frost protection for the plant
74	Max. limitation of room temperature	---	---, 0.5...4 K K	Limit value: nominal setpoint plus setting on this line. --- = function deactivated

Block „Actuator heat exchanger“

81	Actuator Y1 running time common flow	120 s	10...873 s s	
82	P-band common flow control	35 K	1...100 K K	
83	Integral action time common flow control	120 s	10...873 s s	
85	Max. limitation of common flow temperature	---	Variable*... 140 °C °C	* Min. value = operating line 86 --- = no limitation
86	Min. limitation of common flow temperature	---	8 °C... variable* °C	* Max. value = operating line 85 --- = no limitation

Block „Actuator heating circuit“

91	Actuator running time heating circuit	120 s	10...873 s s	
92	P-band heating circuit control	35 K	1...100 K K	
93	Integral action time heating circuit control	120 s	10...873 s s	
94	Setpoint boost for control of the common flow	10 K	0...50 K K	
95	Max. limitation of flow temperature heating circuit	---	Variable*... 140 °C °C	* Min. value = operating line 96 --- = no limitation
96	Min. limitation of flow temperature heating circuit	---	8 °C... variable* °C	* Max. value = operating line 95 --- = no limitation

Block „D.h.w heating“

101	Release of d.h.w. heating	0	0...3	0 = permanently (24 h / day) 1 = acc. to the d.h.w. program 2 = acc. to the heating program 3 = acc. to the heating program with forward shift (operating line 109)
102	Release of circulating pump	1	0...2	0 = permanently (24 h / day) 1 = acc. to the d.h.w. program 2 = acc. to the heating program
103	D.h.w. switching differential	5 K	1...20 K K	
104	Legionella function	6	---, 1...7, 1-7	1 = Monday 2 = Tuesday, etc. 1-7 = entire week --- = no legionella function
105	Setpoint legionella function	65 °C	60...95 °C °C	

Line	Function, display	Default	Range	Setting	Explanations, notes and tips	
106	D.h.w. priority	4	0...4	<i>D.h.w. priority</i>	
					<i>Flow temp. set-point acc. to:</i>	
					0 = absolute priority	d.h.w.
					1 = shifting priority	d.h.w.
					2 = shifting priority	max. selection
3 = none (parallel)	d.h.w.					
4 = none (parallel)	max. selection					
107	Overrun time charging pump Q3	4 min	0...40 min min	Plant type no.3: changeover valve	
108	Overrun time charging pump (Q7 in the secondary d.h.w. circuit, after Q3)	4 min	0...40 min min		
109	Max. time d.h.w. heating	150 min	---, 5...250 min min	--- = function deactivated	

Block „D.h.w. actuator 1“

111	Actuator Y5 opening time d.h.w. circuit	35 s	10...873 s s	
112	Actuator Y5 closing time d.h.w. circuit	35 s	10...873 s s	
113	P-band d.h.w. control (Y5)	35 K	1...100 K K	
114	Integral action time d.h.w. control (Y5)	35 s	10...873 s s	
115	Derivative action time d.h.w. control	16 s	0...255 s s	
116	Setpoint boost with d.h.w. heating	16 K	0...50 K K	
117	Max. d.h.w. temperature setpoint	65 °C	20...95 °C °C	

Block „D.h.w. actuator 2“

121	Actuator running time, mixing valve Y7 in the secondary d.h.w. circuit	35 s	10...873 s s	
122	P-band d.h.w. control	35 K	1...100 K K	
123	Integral action time d.h.w. control	35 s	10...873 s s	

Block „D.h.w. load limit“

124	Load limit when flow switch is activated	25 %	0...60 % %	Setting in % of the current max. stroke
-----	--	------	----------	---------	---

Block “Additional legionella functions”

126	Time for charging	--:--	--:--, 00:00...23:50	... : ...	
127	Dwelling time at legionella setpoint	---	---, 10...360 minmin	
128	Circulating pump operation during legionella function	1	0 / 1	...	0 = no 1 = yes

Block „Test and display“

141	Sensor test 0 = outside sensor (B9) 1 = flow temperature sensor (B1) 2 = d.h.w. temperature sensor (B3) 3 = room unit sensor (A6) 4 = primary return temp. sensor (B7) 5 = universal sensor (B71)	0	0...5		— = open circuit or no sensor ooo = short-circuit
142	Relay test 0 = normal operation (no test) 1 = all relays de-energized 2 = relay at terminal Y1 energized 3 = relay at terminal Y2 energized 4 = relay at terminal Q1 energized 5 = relay at terminal Q3/Y7 energized 6 = relay at terminal Y5 energized 7 = relay at terminal Y6 energized 8 = relay at terminal Q7/Y8 energized	0	0...8		To terminate the relay test: • Select another operating line • Press an operating mode button • Automatically after 8 minutes Note: with plant type 5, perform relay test only when main valve is closed! Recommendation: always close main valve when making the relay test

Line	Function, display	Default	Range	Setting	Explanations, notes and tips
143	Display of active limitations		Display function		<i>Max. limitation f</i> : 1 = primary return temperature 2 = common flow temperature 3 = secondary flow temperature heating circuit 4 = temperature differential 5 = room temperature <i>Min. limitation j</i> : 11 = reduced room temperature setpoint 12 = common flow temperature 13 = secondary flow temperature heating circuit
145	Address and identification of device at terminal A6		Display function		1 82 = room unit QAW50 1 83 = room unit QAW70 1 90 = room temperature sensor QAA10
146	Status at terminal H5		Display function		H5 0 = H5-contact open H5 1 = H5-contact closed
149	Reset of operating lines 56...128				Press and until display changes: 0 (flashing) = normal status 1 = reset to factory settings completed
150	Software version		Display function		

Settings on the “Locking functions“ level

To access the “Locking functions“ level, proceed as follows:

1. Press and simultaneously for 6 seconds
2. The display shows **Cod 00000**
3. Enter the code (for information about code, contact your Siemens Building Technologies service centre)

The “End-user“ and “Heating engineer’s“ levels remain activated.

Block „Locking functions“

151	Max. limitation of primary return temperature, constant value	---	---, 0...140 °C °C	
152	Max. limitation of primary return temperature, slope	7	0...40	
153	Max. limitation of primary return temperature slope, start of shifting limitation	10 °C	-50...+50 °C °C	
154	Max. setpoint of return temperature with d.h.w. heating	---	---, 0...140 °C °C	Only with plant types 2, 3, 7 and 8 --- = function deactivated
155	Integral action time primary return temperature limitations	15 min	0...60 min min	
156	Max. limitation of temperature differential (between primary return and secondary return temperature)	--.	--., 0.5...50 °C °C	Only with plant types 1, 2, 3, 4, 6 and 7 --. = function deactivated
157	Max. setpoint of the return temperature during d.h.w. heating on legionella setpoint	---	--- / 0...140 °C °C	
161	Raising the reduced room temperature setpoint	0	0...10	Effect of outside temperature on the reduced setpoint of the room temperature 0 = function deactivated
162	Daily forced d.h.w. heating at the start of release period 1	1	0 / 1		Only with plant types 2, 3, 6, 7 and 8 0 = function deactivated 1 = function activated
163	Idle heat function primary flow	---	---, 3...255 min min	Only with plant types 4 and 5 --- = function deactivated If B7 is available, place sensor as indicated:
191	Locking on the hardware side	0	0 / 1		0 = no locking 1 = code can be entered only when terminals B71–M on the base are bridged

Keep Instructions

After the settings have been entered in the tables, keep the Installation Instructions in a safe place!

Dimensions

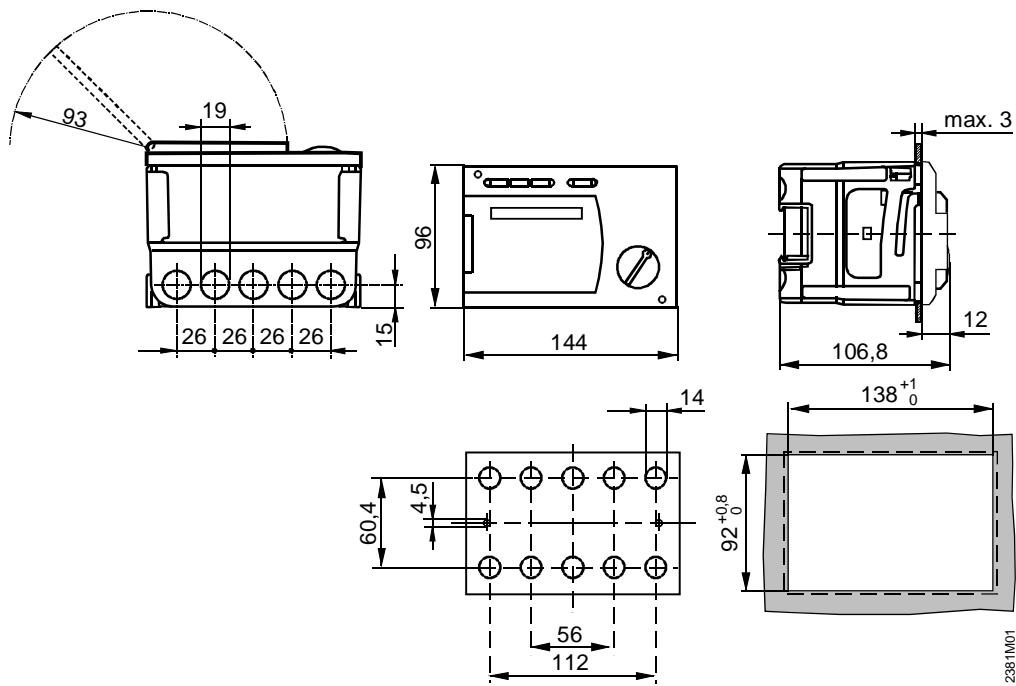

2381M01

Dimensions in mm