



Modulating Control Valve PN 16 with Magnetic Actuator

M3K...FX...N
M3K...FX...NP

for brine circuits, hot water, steam or media containing mineral oils (M3K...FX...NP)

- **Fast positioning time (< 2 s)**
- **High-resolution stroke and rangeability**
- **Operating voltage AC 24 V or power signal DC 0...20 V Phs (phase cut)**
- **Selectable electrical interface DC 0...10 V, DC 4...20 mA or DC 0...20 V Phs**
- **Fail-safe feature: control path 1 → 3 closed when de-energised**
- **Low friction, robust, no maintenance required**

Use

The control valves are mixing or throughport valves with the magnetic actuator ready fitted.

The short positioning time, high resolution and high rangeability make these valves ideal for modulating control of chilled water, low-temperature hot water, high-temperature hot water, hot water and steam systems or media containing mineral oils in closed circuits of heating, ventilating and air conditioning systems as well as industry related applications.

Type summary

Type reference ¹⁾	DN	k_{VS}	Δp_{max}	Δp_S	S_{NA}	P_{med}	I_N	Wire cross-section [mm ²] 4-wire connection		
		[m ³ /h]	[kPa]	[kPa]				4.0	2.5	4.0
M3K15FX06N	15	0.6	500	500	20	5	3.15	40	65	110
M3K15FX15N		1.5								
M3K15FXN		3.0								
M3K20FXN	20	5.0	300	300	26	6	4	30	50	80
M3K25FXN	25	8.0								
M3K32FXN	32	12								
M3K40FXN	40	20								
M3K50FXN	50	30			40	10	6.3	20	30	50

¹⁾ Version for media containing mineral oils with type suffix P, e.g. M3K50FXNP

Δp_{max} = max. permissible differential pressure across the valve's control path, valid for the entire actuating range of the motorised valve

Δp_S = max. permissible differential pressure (close off pressure) at which the motorised valve will close securely against the pressure (used as throughport valve)

S_{NA} = nominal apparent power for selecting the transformer

P_{med} = typical power consumption

I_N = required slow fuse

k_{VS} = nominal flow rate of cold water (5 to 30 °C) through the fully opened valve (H_{100}) at a differential pressure of 100 kPa (1 bar)

L = max. cable length; with 4-wire connections, the max. permissible length of the separate 1.5 mm² copper positioning signal cable is 200 m.

Accessories

Terminal housing ZM...

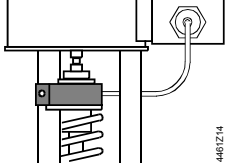
Type reference	Operating voltage	Positioning signal	Operating range	Data sheet
ZM101/A ²⁾	AC 24 V	DC 0...10 V	DC 4...8 V	N4591
ZM121/A ²⁾	AC 24 V	DC 4...20 mA	DC 12...16 mA	
ZM111		DC 0...20 V Phs	DC 10...15 V Phs	
Description				
Z366	AC / DC 24 V, 10 W; required for medium temperatures < 0 °C			
Z155/... (... = DN)	with blank flange, seal, screws, spring washers and nuts			

Stem heating element

Blank flange set

²⁾ For the ZM101/A and ZM121/A types also the DC 0...20 V Phs positioning signal is possible without operating voltage.

Order

When ordering, please give quantity, product name and type reference.

Example:

- 1 valve M3K25FXN
- 1 terminal housing Z101/A
- 1 stem heating element Z366
- 1 blank flange set Z155/25F

Delivery

Valve body and magnetic actuator form one assembly and cannot be separated. The terminal housing, the stem heating element and the blank flange set are delivered in a separate package

Technical and mechanical design

For a detailed description of operation, refer to Data Sheet CA1N4028E.

Control operation

The electronics module converts the positioning signal to a phase-cut power signal which generates a magnetic field in the coil. This causes the armature to change its position in accordance with the interacting forces (magnetic field, counterspring, hydraulics, etc.). The armature responds rapidly to any change in signal, transferring the corresponding movement directly to the valve plug, enabling fast changes in load to be corrected quickly and accurately.

Spring return facility

If the positioning signal is interrupted, or in the event of a power failure, the valve's return spring will automatically close control path 1 → 3.

Control

The magnetic actuator can be driven by a Siemens controller or a controller of other manufacture that deliver a DC 0...10 V, DC 4...20 mA or DC 0...20 V Phs output signal. To achieve optimum control performance, it is recommended to use a 4-wire connection.

Manual operation

Control path ports 1 → 3 can be opened mechanically to between 0 and approximately 90 %, by turning the handwheel clockwise (CW).

The manual adjustment facility can also be used as a mechanical method of low limit control, i.e. the valve will exercise its normal control function between the manually-set position and the 100 % open position. For full-stroke automatic control, the handwheel must be set to 0 (the anticlockwise end-stop).

Sizing

Flow chart

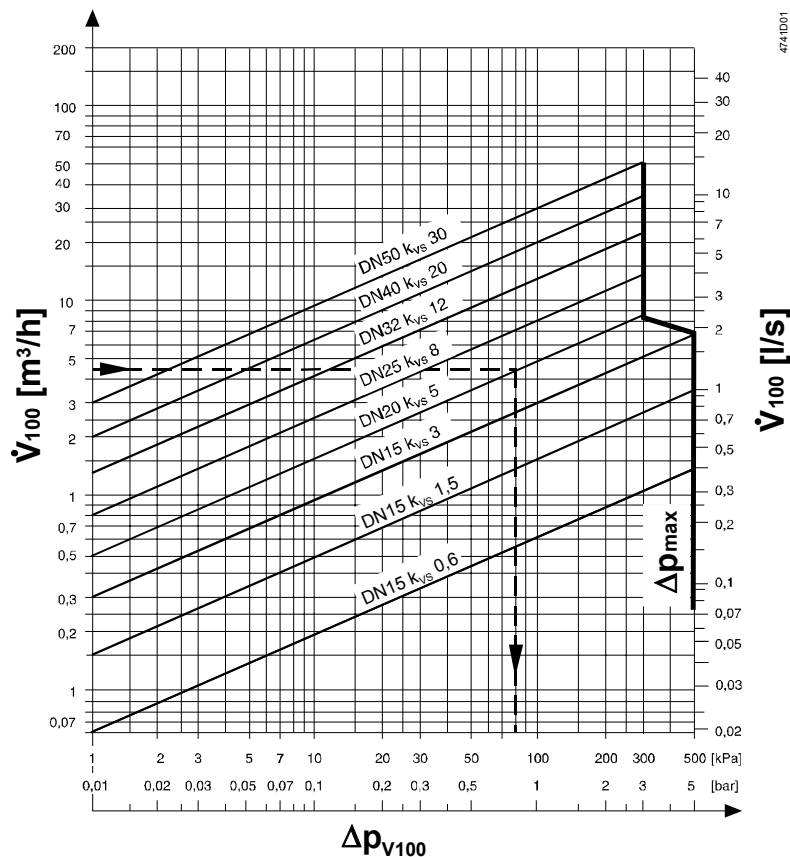

Δp_{V100} = differential pressure across the fully open valve and the valve's control path 1 → 3 by a volumetric flow \dot{V}_{100}

\dot{V}_{100} = volumetric flow through the fully open valve (H_{100})

Δp_{max} = max. permissible differential pressure across the valve's control path for the entire actuating range of the motorised valve

100 kPa = 1 bar \approx 10 mWC

1 m³/h = 0.278 l/s water at 20 °C

Water with additives

To determine the volumetric flow \dot{V}_{100} in case of anti-freeze proportions > 20 % use the following formula:

$$\dot{V}_{100} = \frac{Q_{100}}{1.163 \cdot \Delta T \cdot f_1} \quad [m^3/h]$$

\dot{V}_{100} = Volumetric flow [m³/h]
 Q_{100} = Nominal system output [kW]
 ΔT = Temperature differential [K]
 between flow and return
 f_1 = Correction factor

The correction factor f_1 can be taken from the following table or calculated with the formula below.

Table
correction factor f_1
for Antifrogen N:

N [%]	Temperature [°C]							
	-40	-20	0	20	40	60	80	100
100	0.60	0.62	0.63	0.65	0.67	0.68	0.69	0.71
80	0.71	0.73	0.74	0.75	0.77	0.78	0.79	0.80
60	0.79	0.80	0.81	0.82	0.84	0.85	0.86	0.86
52	0.82	0.83	0.84	0.85	0.86	0.87	0.88	0.88
44		0.87	0.88	0.88	0.89	0.90	0.90	0.90
34		0.92	0.92	0.92	0.92	0.92	0.93	0.93
20			0.97	0.97	0.97	0.96	0.96	0.95

The data and application notes of the anti-freeze manufacturer are binding.

Calculation correction
factor f_1 :

$$f_1 = \frac{c \left[\frac{kJ}{kgK} \right] \cdot \rho \left[\frac{kg}{m^3} \right]}{4.18 \cdot 1000}$$

f_1 = Correction factor = 1 for water
 c = Specific heat of anti-freeze [kJ/kgK]
 ρ = Density of anti-freeze [kg/m³]
 4.18 = Specific heat of water at 20 °C [kJ/kgK]
 1000 = Density of water at 20 °C [kg/m³]

For valve sizing with media other than water, note that the following media properties differ from those of water.

- specific heat
- density
- kinematic tenacity

All variables are temperature-dependent.

The design temperature equals the lowest media temperature prevailing in the valve.

General formula:

$$\dot{V}_{100} = \frac{Q_{100} \cdot 3600}{c \cdot \Delta T \cdot \rho} \quad [m^3/h]$$

\dot{V}_{100} = Volumetric flow [m³/h]
 Q_{100} = Nominal system output [kW]
 ΔT = Temperature differential [K]
 between flow and return
 c = Specific heat [kJ/kgK]
 ρ = Specific density [kg/m³]

Note

In HVAC plants, the kinematic viscosity ν [mm²/s] is always below 20 mm²/s so that its impact on volumetric flow is negligible

Mounting Notes

Mounting Instructions are included in the packaging:

No: 35582 (valve)

No. 35541 (terminal housing ZM...)

Vorsicht 

The valve may only be used as a mixing or throughport valve, not as a diverting valve. Observe the direction of flow!!

A strainer should be fitted upstream of the valve. This increases reliability.

Orientation

Any

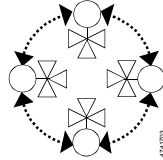

Use as straight-through valves

Only three-way valves are supplied. They may be used as straight-through valves.

Port «2» can be sealed with Z155/... which must be ordered as a separate item. The blank flange set comes complete with blank flange, seal, screws, spring washers and nuts.

DN15...DN32 blank flange (Z155/15F...Z155/32F)

DN40...DN50 blank flange (Z155/40...Z155/50)

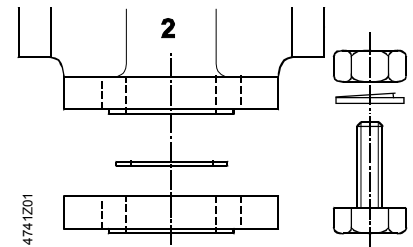

Installation Notes

The actuator may not be lagged.

For notes on electrical installation, see «Connection terminals» resp. «Connection diagrams»

Maintenance Notes

The valves and actuators are maintenance-free.

The low friction and robust design make regular servicing unnecessary and ensure a long service life.

The valve stem is sealed from external influences by a maintenance-free gland.

Caution 

Always disconnect power before fitting or removing the terminal housing.

Caution 

Under operating conditions within the limits defined by the application data, the actuator will become hot, but this does not represent a burn risk. Always maintain the minimum clearance specified, refer to «Dimensions».



Disposal

The actuator must not be disposed of together with domestic waste. This applies in particular to the PCB.

Legislation may demand special handling of certain components, or it may be sensible from an ecological point of view

Current local legislation must be observed.

Warranty

Application-specific technical data must be observed.

If specified limits are not observed, Siemens Switzerland Ltd / HVAC Products will not assume any responsibility.

Technical Data

Functional actuator data

Power supply	Extra low-voltage only (SELV, PELV)			
Operating voltage ¹⁾	AC 24 V, + 15 % / -10 %			
Frequency	50...60 Hz			
Typical power consumption P_{med}	refer to table «Type summary»			
Rated apparent power S_{NA}	refer to table «Type summary»			
Input	Positioning signal	ZM101/A DC 0...10 V or DC 0...20 V Phs		
		ZM121/A DC 4...20 mA or DC 0...20 V Phs		
		ZM111 DC 0...20 V Phs		
Current draw	DC 0...10 V	max. 1 mA		
Impedance	DC 4...20 mA	2 x 56 k Ω		
Functional valve data	PN class	PN 16 to EN 1333		
	Permissible operating pressure			
	Water up to 120 °C	1.6 MPa (16 bar)		
	Water > 120 °C	1.3 MPa (13 bar)		
	Saturated steam \leq 180 °C	1.0 MPa (10 bar) abs		
	Leakage rate	1 \rightarrow 3	max. 0.05 % k_{vs} (to DIN EN 1349)	
		2 \rightarrow 3	approx. 2 % k_{vs} (depending on operating conditions)	
	Permissible media	Brine		
		Water	Chilled water, low-temperature hot water, high-temperature hot water, hot water, water with anti-freeze; recommendation: water treatment to VDI 2035	
		Saturated steam		
	M3K...FX...NP:	Oil mixtures	mineral oils SAE05...SAE50, heat transfer oils	
	Medium temperature		max. 180 °C	
		Water ²⁾	-20...120 °C	1.6 MPa (16 bar)
	Water	> 120 °C	1.3 MPa (13 bar)	
	Saturated steam	\leq 180 °C	1.0 MPa (10 bar) abs	
Valve characteristic (stroke, k_v)	linear (to VDI / VDE 2173), optimised in low opening range			
Stroke resolution $\Delta H / H100$	> 1 : 200 (H = stroke)			
Mode of operation	modulating			
In de-energised position	control path 1 \rightarrow 3 closed			
Mounting position	any			
Positioning time	< 2 s			
Ambient temperature	-5...45 °C			
Materials	Valve body	spheroidal graphite cast iron EN-GJS-400-18-LT		
	Seat / inner valve	CrNi steel		
	Valve stem seal for M...N	EPDM (O ring)		
	Valve stem seal for M...NP	Fluoroelastomer FPM product		
Bellows	CrNi steel			
Electrical connection	Cable entry	2 x PG11 (ZM101/A, ZM111, ZM121/A)		
	Min. cross-sectional area	1.5 mm ²		
Dimensions / weight	Connection terminals	screw terminals for max. 1 x 4 mm ² copper wires		
	Dimensions	refer to «Dimensions»		
	Weight	refer to table in «Dimensions»		

¹⁾ No operating voltage is required for the DC 0...20 V Phs power positioning signal.

²⁾ For medium temperatures < 0 °C, the Z366 stem heating element is required.

Norms and standards

Degree of protection	IP 54 to IEC 60529
Conforming to	CE requirements
Permissible operating pressure	PED 97/23/EC
Pressure accessories	as per article 1, section 2.1.4
Fluid group 2	without CE-marking as per article 3, section 3 (sound engineering practice)

General environmental conditions

	Operation EN 60721-3-3	Transport EN 60721-3-2	Storage EN 60721-3-1
Climatic conditions	Class 3K5	Class 2K3	Class 1K3
Temperature	-5...+45 °C	-25...+70 °C	-5...+45 °C
Humidity	5...95 % r.h.	5...95 % r.h.	5...95 % r.h.
Mechanical conditions	EN 60721-3-6 Class 6M2		

Connection terminals

Warning

If a ZM.../A terminal housing is used with DC 0...20 V Phs (phase cut), AC 24 V must not be connected!

ZM101/A (DC 0...10 V or DC 0...20 V Phs)

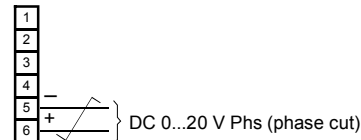
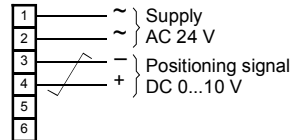

ZM111 (DC 0...20 V Phs)

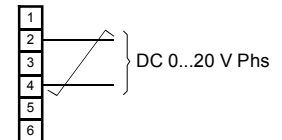

ZM121/A (DC 4...20 mA or DC 0...20 V Phs)

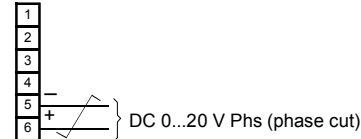
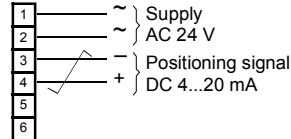

twisted pairs

4721Z03en

Connection diagrams

Refer to data sheet N4591 for the ZM... terminal housings.

Application examples

Hydraulic circuits

The examples shown below are basic diagrams with no installation-specific details.

Caution ⚠

The valve may only be used as a mixing or throughport valve, not as a diverting valve. Observe the direction of flow!

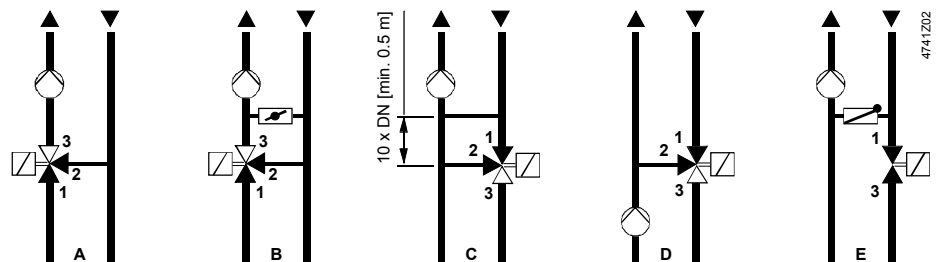

- A Mixing circuit
- B Mixing circuit with bypass (underfloor heating system)
- C Injection circuit
- D Diverting circuit
- E Injection circuit with throughport valve

Dimensions

Dimensions in mm

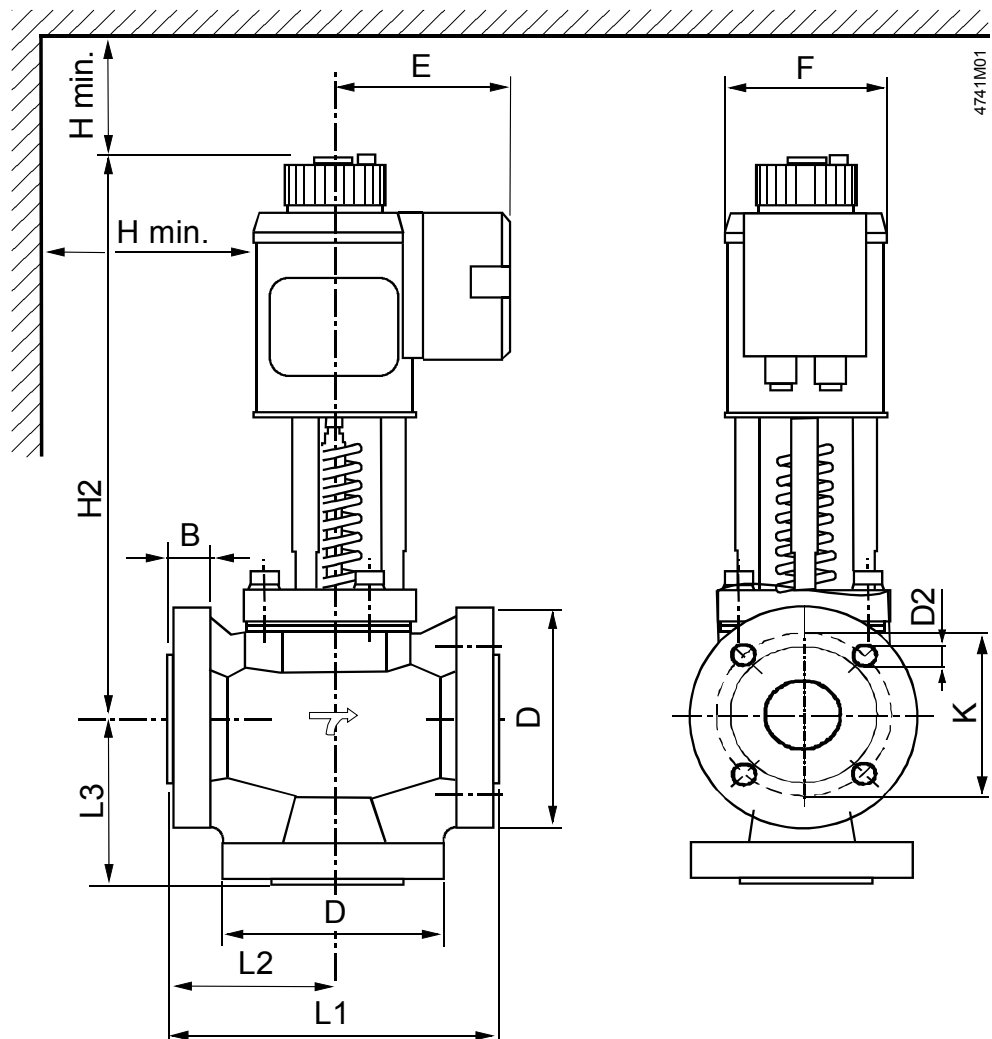

Type reference	DN	B	D	D2	K	L1	L2	L3	H2	H min.	E	F	Weight [kg]
M3K15FX06N	15	14	95	4x14	65	130	65	65	283	100	84	80	7
M3K15FX15N													
M3K15FXN													
M3K20FXN	20	16	105	75	150	75	75	282	9				
M3K25FXN			115								85	160	80
M3K32FXN	32	18	140	4x18	100	180	90	90	325		150	94	100
M3K40FXN	40		150		110	200	100	100	324	18			
M3K50FXN	50		20		165	125	230	115	105	343			

Remarks:

- Flange dimensions to ISO 7005-2 / DIN 2533, PN 16
- Weight including packaging