



ACVATIX™

## Modulating pilot valve, PN 32

**M2FP03GX**

to control main valves

- 
- **Short positioning time (approx 1 s)**
  - **High resolution**
  - **Hermetically sealed**
  - **Versatile electrical interface with terminal housing ZM..**
  - **Friction free**
  - **Robust and maintenance-free**

### Use

---

Modulating pilot valve with magnetic actuator as the controlling element for 2...5" main valves for modulating control of chillers, or for direct control of low  $k_{vs}$  values. Suitable for use with safety refrigerants such as R22, R134a, R404A, R407C, R507 and for ammonia R717. Unsuitable for applications with gas/liquid mixtures.

## Type summary

Product number	$k_{vs}$ [m <sup>3</sup> /h]	$\Delta p_{max}$ [MPa]
<b>M2FP03GX</b>	0.3	1.8

$\Delta p_{max}$  = Maximum permissible differential pressure across the valve's control path 1 → 3 valid for the entire actuating range

$k_{vs}$  = Nominal flow rate of cold water through the fully open valve ( $H_{100}$ ) by a differential pressure of 100 kPa (1 bar), to VDI 2173

## Accessories / terminal housing ZM..

Product number	Operating voltage	Positioning signal	Working range	Data sheet
<b>ZM101/A</b>	AC 24 V	DC 0...10 V	DC 4...8 V	N4591
<b>ZM121/A</b>	AC 24 V	DC 4...20 mA	DC 8...16 mA	
<b>ZM111</b>		DC 0...20 V Phs	DC 10...15 V Phs	

For the ZM101/A and ZM121/A types also the DC 0...20 V Phs positioning signal is possible without operating voltage.

## Ordering

The M2FP03GX pilot valve and the ZM.. or ZM../A terminal housing must be ordered separately.

When placing an order, please specify the quantity, product description and type code.

Product number	Stock number	Description
M2FP03GX	M2FP03GX	Pilot valve
ZM101/A	ZM101/A	Terminal housing

## Delivery

Pilot valve and terminal housings are packed separately.

## Technical and mechanical design

The armature or magnetic core is designed as a floating component within the pressure system, so that no external shaft gland is required. The leakage losses common with moving parts are thus avoided.

The control signal is converted in the ZM.../A terminal housing into a phase cut signal, which generates a magnetic field in the coil. This causes the only moving part, the armature, to change its position in accordance with the interacting forces (magnetic field, counter-spring, hydraulics etc.). The armature responds rapidly to any change in signal, transferring the corresponding movement directly to the control disc, enabling fast changes in load to be corrected quickly and accurately. The force of the counter-spring automatically retracts the valve stem if the power is switched off or fails (valve control path closes).

## Application examples

The diagrams shown here are principles only, without installation-specific details.

### Suction throttle control

Screw-in valve application such as Danfoss PM.. main valve.

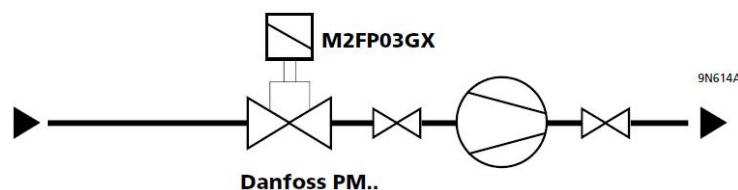

## Engineering notes

---

**Caution** The characteristics of the main valve and the manufacturer's recommendations must be observed.

## Mounting notes

---

Mounting instructions are enclosed with the valve:

- Nr. 35552 (pilot valve)

The pilot valve can be mounted in any orientation, but upright mounting is preferable.

To protect the valve from dirt, a mesh filter should be fitted on the supply side (mesh gauge 0.1...0.2 mm).

The pilot valve can be fitted directly to various commercially available main valves, with the M24 x 1.5 screwed spigot.

**Attention**  Note, however, that it must not be screwed into the valve body until welding or soldering work is complete.

To prevent damage to the O-ring and to protect the pilot valve from dirt and metal fillings, the protective cap on the spigot should not be removed until immediately before the valve is fitted.

**Attention**  Always switch off the power supply before connecting or disconnecting the ZM.. terminal housing.

## Maintenance notes

---

The M2FP03GX pilot valve is maintenance-free.

Repair The pilot valve cannot be repaired. It has to be replaced as a complete unit.

## Disposal

---



The device is considered electrical and electronic equipment for disposal in terms of the applicable European Directive and may not be disposed of as domestic garbage.

- Dispose of the device through channels provided for this purpose.
- Comply with all local and currently applicable laws and regulations.

## Warranty

---

Application-specific technical data must be observed.

**If specified limits are not observed, Siemens will not assume any responsibility.**

## Technical data

### Functional actuator data

Power supply	Extra low-voltage only (SELV, PELV)	
	Operating voltage <sup>1)</sup>	AC 24 V + 15 % / -10 %
	Frequency	50...60 Hz
	Typical power consumption P <sub>med</sub>	5 W
	Rated apparent power S <sub>NA</sub>	13 VA
	Required fuse I <sub>F</sub>	1 A, slow
	External supply line protection	Fuse slow max. 10 A or Circuit breaker max. 13 A Characteristic B, C, D according to EN 60898 or Power source with current limitation of max. 10 A
Signal inputs	Positioning signal	ZM101/A DC 0...10 V or DC 0...20 V Phs ZM121/A DC 4...20 mA or DC 0...20 V Phs ZM111 DC 0...20 V Phs
	Input resistance	DC 0...10 V > 100 kΩ
	Input resistance	DC 4...20 mA < 150 Ω
Positioning time	Positioning time	approx. 1 s
Electrical connections	Cable entry	2 x Pg11 (ZM101/A, ZM121/A)
	Connection terminals	max. 4 mm <sup>2</sup> wire cross-section
	Min. wire cross-section	0.75 mm <sup>2</sup>
Functional data valve	Permissible operating pressure	3.2 MPa (32 bar)
	Max. differential pressure Δp <sub>max</sub> 1 → 3	1.8 MPa (18 bar)
	Leakage at Δp = 100 kPa (1 bar) 1 → 3	approx. 0.25 % k <sub>vs</sub> (to VDI/VDE 2174)
	Valve characteristic	linear (to VDI / VDE 2173)
	Permissible media	for safety refrigerants (R22, R134a, R404A, R407C, R507 etc.), ammonia (R717)
	Medium temperature	-40...100 °C
	Position when de-energized	Valve stem retracted (valve control path closed)
	Orientation	any
	Mode of operation	modulating
	Materials	Body
Seat / inner valve		CrNi steel
Dimensions and weight	Dimensions	refer to «Dimensions»
	Weight	1.64 kg (including packaging)
Connection to main valve	Threaded connection	M24 x 1.5 mm
Norms and directives	Electromagnetic compatibility (Application)	For residential, commercial and industrial environments
	Product standard	EN 60730-x
	EU Conformity (CE)	CA2T4731xx <sup>2)</sup>
	EAC conformity	Eurasia conformity
	Electrical safety	EN 60730-1
	Housing protection Upright to horizontal	IP54 to EN 60529

<sup>1)</sup> No operating voltage is required for the DC 0...20 V Phs power positioning signal.

<sup>2)</sup> The documents can be downloaded from <http://siemens.com/bt/download>

S<sub>NA</sub> = Rated apparent power for transformer selection

P<sub>med</sub> = Typical power consumption

Pressure Equipment Directive	PED 2014/68/EU
Pressure Accessories	Scope: Article 1, section 1 Definitions: Article 2, section 5
Fluid group 2	without CE-marking as per article 4, section 3 (sound engineering practice)
Environmental compatibility	Environmental Declaration contains data on environmental-compatible product design and assessment (RoHS compliance, compositions, packaging, environmental benefits and disposal).

### General environmental conditions

	Operation EN 60721-3-3	Transport EN 60721-3-2	Storage EN 60721-3-1
Climatic conditions	Class 3K6	Class 2K3	Class 1K3
Temperature	-40...50 °C	-25...70 °C	-5...45 °C
Humidity	10...100 % r. h.	< 95 % r. h.	5...95 % r. h.

### Connection terminals

#### Attention

If a ZM../A terminal housing is used with DC 0...20 V Phs (phase cut), AC 24 V must not be connected!

Always switch off the power supply before connecting or disconnecting the ZM... terminal housing.

#### ZM101/A (DC 0...10 V or DC 0...20 V Phs)

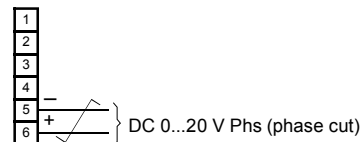
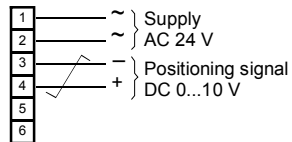

#### ZM111 (DC 0...20 V Phs)

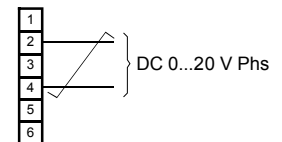

#### ZM121/A (DC 4...20 mA oder DC 0...20 V Phs)

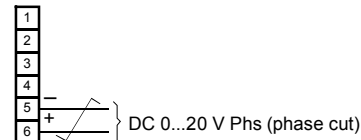
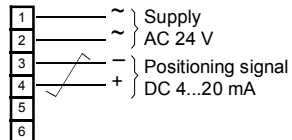

 twisted pairs

4721203en

### Connection diagrams

Refer to data sheet N4591 for the ZM.. terminal housings

## Dimensions

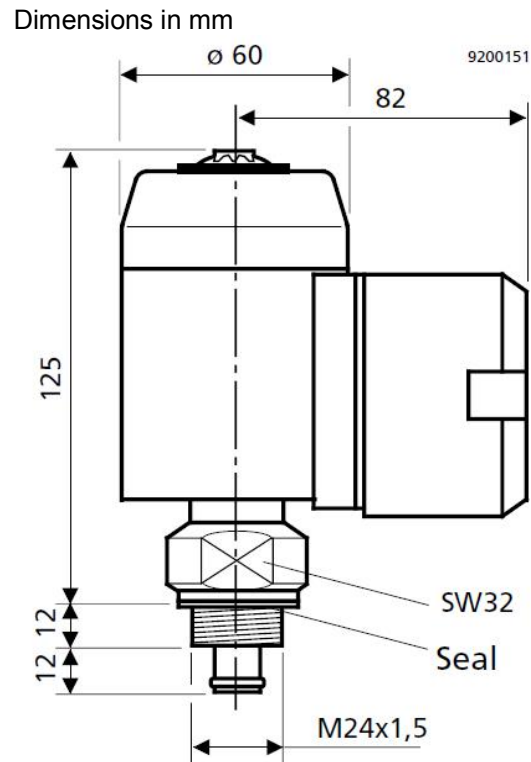

## Revision number

Type reference	Valid up to rev. No.
M2FP03GX	..F

Issued by  
Siemens Switzerland Ltd  
Building Technologies Division  
International Headquarters  
Gubelstrasse 22  
6301 Zug  
Switzerland  
Tel. +41 58-724 24 24  
[www.siemens.com/buildingtechnologies](http://www.siemens.com/buildingtechnologies)

© Siemens Switzerland Ltd, 2010  
Technical specifications and availability subject to change without notice.