



REV23.03RF

REV-R.03/1

REV23RF/SET

Self-learning Room Temperature Controller Receiver

REV23.03RF
REV-R.03/1

Consisting of controller (with integrated radio transmitter) and receiver (switching unit with relay outputs)

- **Mains-independent room temperature controller**
- **Straightforward, self-explanatory menu selection via roller selector**
- **Self-learning 2-position controller providing PID mode (patented)**
- **Choice of operating modes:**
 - Automatic with maximum 3 heating or cooling periods, continuously comfort, continuously economy, frost protection with one 24-hour operating mode including one heating or cooling period**
- **In automatic mode, one temperature setpoint can be entered for each heating or cooling period**
- **Optional control of cooling equipment**
- **Advantageous for retrofitting and upgrading projects (wireless room unit)**

Use

For control of the room temperature in:

- Apartments, single-family or holiday houses
- Offices, individual rooms, consulting rooms or commercially used spaces

For control of the following pieces of equipment:

- Solenoid valves of instantaneous water heaters

- Solenoid valves of atmospheric gas burners
- Forced draft gas or oil burners
- Circulating pumps of heating systems, zone valves
- Electric direct heating systems or fans of electric storage heaters
- Thermal actuators
- Cooling and refrigeration equipment

Functions

- Radio signal transmission
- PID control with self-learning or selectable switching cycle
- 2-position control
- Automatic mode with 7-day switching program for 24-hour, working day, weekend or 7-day operation with up to 3 heating or cooling periods per day
- Each heating or cooling period has its own temperature setpoint
- One 24-hour operating mode with one heating or cooling period
- Override button
- Sensor calibration and reset function
- Frost protection or overtemperature protection
- Limitation of the minimum setpoint
- Holiday mode
- Heating or cooling mode
- Periodic pump run
- Optimum start control with the first heating period

Type summary

Radio signal equipment consisting of:

Room temperature controller (transmitter), receiver (switching unit) and support

Room temperature controller (transmitter) and support

Receiver (switching unit)

REV23RF/SET

REV23.03RF

REV-R.03/1

Ordering

When ordering, please give the type references according to «Type summary». The controller / transmitter REV23.03RF is supplied complete with batteries.

Technical design

Display and operating elements

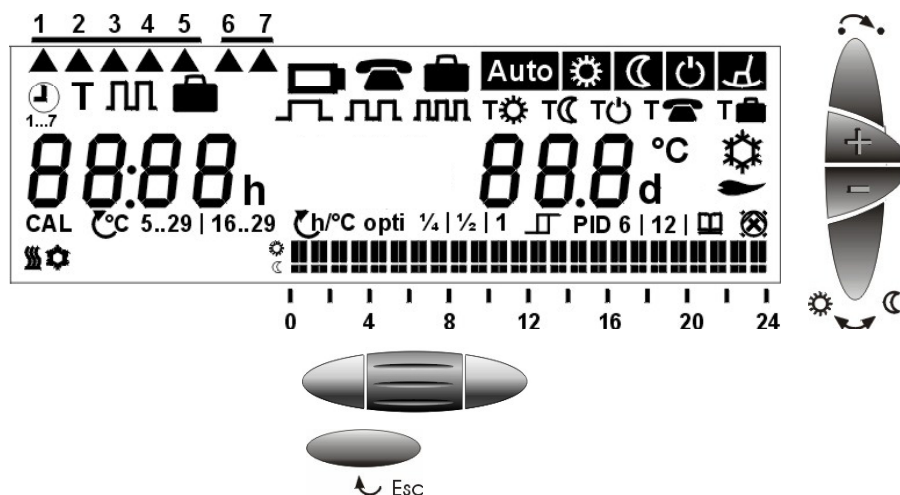

Operating elements

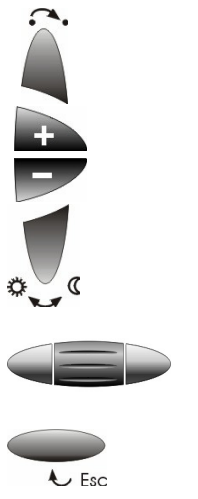
	<p>Selection of operating mode (see below)</p> <p>«Warmer» button</p> <p>«Colder» button</p> <p>Override button (see below)</p> <p>Roller selector for the menu, submenu and the settings</p> <p>Confirm by pressing</p> <p>Leaving the current menu level and returning to the menu level previously active (settings currently displayed will be accepted)</p>
---	--



Displays

	<p>Time of day</p> <p>Room temperature</p> <p>Change batteries (display appears about 3 months before batteries are exhausted)</p> <p>Holiday mode active</p>
--	---

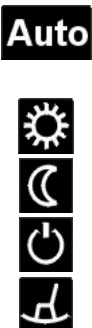

Selection of operating mode (only one operating mode active)

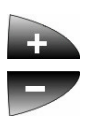
		<p>Automatic mode</p> <p>Comfort mode</p> <p>Economy mode</p> <p>Frost protection or overtemperature protection</p> <p>24-hour mode with one heating or cooling period (heating or cooling period is individually adjustable)</p>
---	---	---











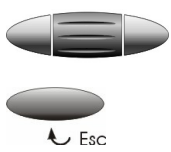

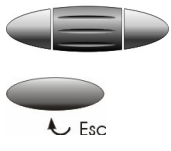



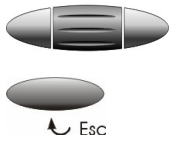

Temporary change of the current setpoint temperature (change only active until the next switching point is reached)

		<p>Press the + or – button once to display the adjusted temperature setpoint. It can be readjusted in increments of 0.2 °C (max. +/- 4 °C)</p>
---	---	--

Override button

	<p>In operating modes Auto and , this button can be used to manually switch from comfort to economy temperature, or vice versa. The selection is automatically reset when the next switching point is reached or when the operating mode is changed</p>
---	---

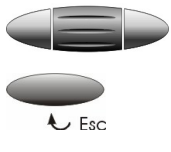
Menu-driven user settings: 4 main menus are available

Time of day and weekday	Main menu	Submenu	Settings												
	 1...7	12:00h 1 2 3 4 5 6 7 	Current time Current weekday												
Temperature	Main menu	Submenu	Default settings – heating / cooling												
	T	T  T  T  T 	<table border="1"> <tr> <td>Setpoint of comfort mode</td> <td>19 °C</td> <td>23 °C</td> </tr> <tr> <td>Setpoint of economy mode</td> <td>16 °C</td> <td>29 °C</td> </tr> <tr> <td>Setpoint frost or overtemperature protection</td> <td>5 °C</td> <td>35 °C</td> </tr> <tr> <td>Setpoint remote operation is not used with this unit</td> <td>(10 °C)</td> <td>(30 °C)</td> </tr> </table>	Setpoint of comfort mode	19 °C	23 °C	Setpoint of economy mode	16 °C	29 °C	Setpoint frost or overtemperature protection	5 °C	35 °C	Setpoint remote operation is not used with this unit	(10 °C)	(30 °C)
Setpoint of comfort mode	19 °C	23 °C													
Setpoint of economy mode	16 °C	29 °C													
Setpoint frost or overtemperature protection	5 °C	35 °C													
Setpoint remote operation is not used with this unit	(10 °C)	(30 °C)													
Time switch	Main menu	Submenu	Settings												
		1 2 3 4 5 6 7   06:00h      	Selection of weekday, working day, weekend or week Selection of the number of heating or cooling periods (max. 3 periods per day) Selection of the heating / cooling period's start and end time Selection of the heating / cooling period's temperature setpoint												
Absence	Main menu	Submenu	Settings												
		T 	Entry of holidays or periods of absence. Number of days with economy mode setting / max. 99 days Temperature setpoint during absence. Default setting is 12 °C for heating and 30 °C for cooling												

Menu-driven heating engineer settings	Menu items	Settings
	CAL	Sensor calibration
	°C 5..29 16..29	Setpoint limitation
	h/°C opti ¼ ½ 1	Optimum start control for the first heating period (in unit of time per 1 °C)
		2-position control
	PID	PID mode, self-learning
	PID 6 12	PID mode, switching cycle 6 or 12 minutes
		Periodic pump run off / on
		Heating / cooling mode

Temperature setpoints

In automatic operating modes, the temperature setpoints can be individually adjusted for every comfort period and for the continuous operating modes. The temperature setpoint of economy mode is the same in automatic and continuous operation.

Protective function



In frost or overtemperature protection mode, the room temperature is constantly monitored. If it falls (rises) below (above) the adjusted setpoint, control to the adjusted frost or overtemperature protection setpoint T_{OP} will be ensured.

24-hour operating mode







The controller operates in 24-hour operating mode according an individually adjustable 24-hour program with 1 heating / cooling period.

To adjust heating / cooling period, select 24-hour operating mode and adjust time program and desired temperature setpoint by roller selector.

24-hour operating mode is maintained until another operating mode is selected.

Switching program



The switching program can be used as a 7-day or 24-hour program, depending on programming. It is also possible to select one of the continuous operating modes     with which the switching program is not used.

With the 7-day program, all individual days, working days (1-5), weekend (6-7), or the entire week (1-7) can be programmed.

For each heating / cooling period, 3 different switching patterns are available.

There is a choice of 1, 2 or 3 heating / cooling periods. For each heating / cooling period, the start time, end time and comfort setpoint are to be entered.

In between heating / cooling periods, it is always the same economy temperature setpoint that is used. This economy temperature setpoint can be adjusted on the temperature menu.

Example with 2 heating periods per day

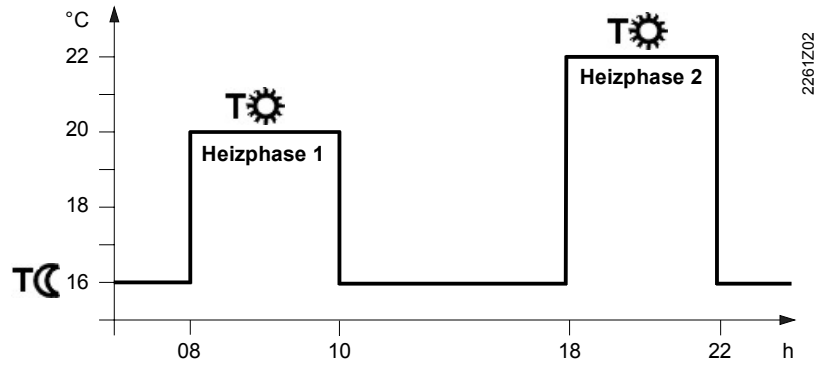

Holiday function



The holiday function is to be selected on the user menu. Set the start of the holiday period (day of departure / $\frac{1}{2} \frac{3}{4} \frac{5}{6} \frac{7}{}$ / weekday), the duration of the holiday period and the temperature setpoint (T). This will enable the controller to maintain the adjusted temperature for a period of up to 99 days. Every day at midnight, the counter subtracts one day.

When the holiday period is over, the counter reads 00, and the controller will automatically resume the operating mode selected last.

Remote operation



To be flexible, the REV23.03RF has no connection facility for remote operation.

Factory settings

Operating mode	Block / week-days	Switching times						Temperatures in °C											
								T 1st period		T 2nd period		T 3rd period		T		T		T	
		1st period		2nd period		3rd period													
Auto	1-5 Mo-Fr 6-7 Sa-Su	06:00	08:00	11:00	13:00	17:00	22:00	19	23	20	23	21	23	16	29				
	1-7 Mo-Su	00:00	24:00					19	23										
	1-7 Mo-Su	00:00	24:00										16	29					
	1-7 Mo-Su	00:00	24:00												5	35			
	1-7 Mo-Su	07:00	23:00					19	23										
	Absence																	12	30

Factory settings
Heating engineer level

Setpoint limitation

5..29

Control mode

2-Point control

Optimum start control

OFF

Periodic pump run

OFF

Heating active

Access

To access the heating engineer level, keep the «Warmer» and «Colder» buttons depressed and simultaneously roll the roller selector away from the display and then toward the display.

Sensor calibration

CAL

If the displayed temperature does not agree with the room temperature effectively measured, the temperature sensor can be recalibrated (recalibration to be made on the heating engineer level.)

The displayed temperature can be matched to the effective room temperature in increments of 0.2 °C (max. ± 2 °C).

Setpoint limitation

°C 5..29 | 16..29

Minimum setpoint limitation to 16 °C prevents undesired heat transfer to neighboring apartments in buildings with several heating zones. The setting is to be made on the heating engineer menu.

Optimum start control

h/°C opti ¼....

Optimization brings forward the switch-on point of the first heating period such that the adjusted setpoint will be reached at the required time.

The setting depends on the type of controlled system, that is, on heat transmission (type of piping system, radiators), building dynamics (building mass, insulation), and heat output (boiler capacity, flow temperature).

Optimum start control is switched off at h/°C opti

Example using an actual room temperature of 18 °C and a setpoint of 20 °C

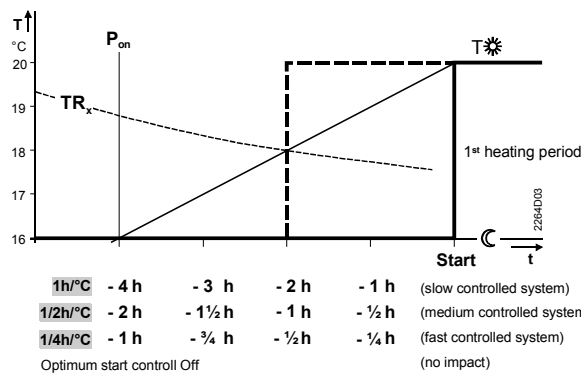

T Temperature (°C) TR_x Actual value of room temperature
 t Forward shift of switch-on point (h) P_{on} Starting point of optimum start control

Control

REV23.03RF is a 2-position controller providing PID mode. The room temperature is controlled by the cyclic switching of an actuating device.

The controller generates the positioning signals depending on the deviation of the setpoint from the actual value acquired by the built-in temperature sensor.

The rate of response to the deviation depends on the selected control algorithm:

Self-learning mode

The controller is supplied with an active self-learning mode, enabling it to automatically adapt to the type of controlled system (building construction, type of radiators, size of the rooms, etc.). After a certain learning period, the controller optimizes its parameters and then operates with the parameters it has learned.

PID

PID 12

PID 12 mode Switching cycle of 12 minutes for normal or slow controlled systems (massive building structures, large spaces, cast-iron radiators, oil burners).

PID 6

PID 6 mode Switching cycle of 6 minutes for fast controlled systems (light building structures, small spaces, plate radiators or convectors, gas burners).



2-Pt mode Pure 2-position control with a switching differential of 0.5 °C (±0.25 °C) for very difficult controlled systems with considerable outdoor temperature variations.

For easy commissioning controller is set to 2-Point mode as factory setting.

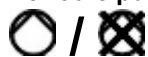
Periodic pump run



Protects the pump against seizing during longer off periods. Periodic pump run is activated for one minute every 24 hours at midnight. This function can be selected on the heating engineer menu.

Periodic pump run active:  / periodic pump run inactive: 

Operating mode Heating / cooling

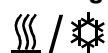

The controller is suited for cooling applications.

The function can be selected on the heating engineer menu.

The controller comes set for heating operation (refer to section «Factory settings»).

User-defined data:

Press the button behind the pin opening for at least one second: This resets the user-specific settings to their default values (heating engineer settings will not be changed). The clock starts at 12:00. During the reset time, all sections of the display are lit, enabling them to be checked.

All user-defined data plus the heating engineer settings:

Press the button behind the pin opening together with the warmer and colder buttons for at least one second.

After the reset, all **factory settings** will be reloaded (also refer to section «Factory settings»).

Mechanical design

Controller

The REV23.03RF has a plastic housing with a large display and easily accessible operating elements. The controller is removed from its base by sliding it upward. It is thus possible to replace the two type **AA** 1.5 V alkaline batteries contained in the compartment at the rear of the controller.

Battery change

About 3 months before the batteries are exhausted, battery symbol  appears on the display, but all functions are fully maintained. When replacing the batteries, the current data will be retained for a maximum of one minute.

Receiver REV-R.03/1

Plastic housing with easily accessible operating elements and removable cover. The unit can be fitted to all commercially available recessed conduit boxes or directly on the wall. A relay with a potential free changeover contact, the connection terminals and the receiving antenna are integrated in the housing.

Base

The base can be fitted to most types of commercially available recessed conduit boxes or directly on the wall.

Support

The support supplied with the controller enables the unit to be put on a shelf. It can be easily fitted to the controller with no need for tools.

Notes

Planning controller / transmitter REV23.03RF

- The room unit should be located in the main living room (on the wall or free-standing using the support provided) while giving consideration to the following points:
- The distance to the receiver should not exceed 20 m or 2 floors
- The unit should be located such that the sensor is able to capture the room temperature as accurately as possible, without getting affected by direct solar radiation or other heat or refrigeration sources (in the case of wall mounting, about 1.5 m above the floor)
- The unit should be located such that it can transmit signals with as little interference as possible. For this reason, the following points should be observed:
 - Do not mount the unit on metal surfaces
 - Not in the vicinity of electrical cables and equipment such as PCs, TV sets, microwave appliances, etc.
 - Not in the vicinity of large metal structures or construction elements with fine metal meshes like special glass or special concrete
- The control mode can be changed via the menu-driven heating engineer settings.
- If the room temperature displayed does not agree with the room temperature effectively measured, the temperature sensor should be recalibrated (refer to «Calibration of sensors»).

Wall mounting of controller / transmitter REV23.03RF

- In the case of wall mounting, ensure that there is sufficient clearance for removing the controller from its base, and for replacing it
First, fit the base. Then, engage the controller from the top. The base can be fitted to most commercially available recessed conduit boxes or directly on the wall

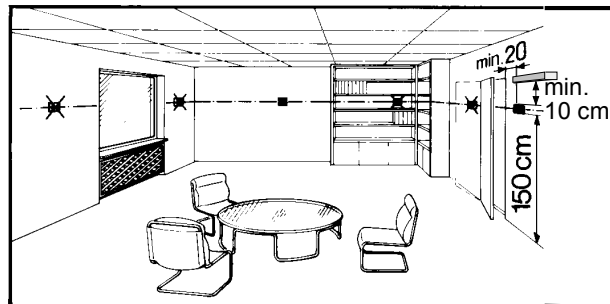

Support of REV23.03RF

- Refer to the Installation Instructions printed on the package.

Planning Receiver REV-R.03/1

- The receiver and switching unit should preferably be mounted near the controlled device
- The unit should be located such that it can receive signals with as little interference as possible. For this reason, the following points should be observed (same as with the transmitter):
 - Not in control panels
 - Not on metal surfaces
 - Not in the vicinity of electrical cables and equipment such as PCs, TV sets, microwave appliances, etc.
 - Not in the vicinity of large metal structures or construction elements with fine metal meshes like special glass or special concrete
- The location where the unit is mounted should be dry and free from splash water
- The unit can be fitted to most commercially available recessed conduit boxes or directly on the wall

Mounting and installation of receiver REV-R.03/1

 The receiver must be wired with the power supply switched off. Mains voltage may be switched on again only after the unit is completely mounted.

- When mounting the unit, the base must first be fitted and wired (L/N = AC 230 V mains supply, LX/L1 = consumers). Then, engage the unit at the top, swing it downward and secure it with a screw
- For more detailed information, refer to the Installation Instructions supplied with the unit

For the electrical installation, the local safety regulations must be complied with.

Commissioning controller/transmitter REV23.03RF and receiver REV-R.03/1



1. Switch on REV23.03RF

- Remove the battery transit tab: As soon as the battery transit tab is removed, the unit starts to operate.

2. Mount REV-R.03/1 temporarily

- If possible, mount receiver temporarily in a first run (e.g. double coated tape). Doing that, location of best RF reception can be identified later on. See clause "5 Find location of best reception"
- Completely wire and mount REV-R.03/1 temporarily (please also close front cover)

3. Link REV-R.03/1 with REV23.03RF

- Switch on power at REV-R.03/1: LED_1 lights always in red or flashes in red
- Press the "RESET" button on REV-R.03/1 for about 4 seconds: The orange LED_2 will flash very fast and briefly (stored address of REV23.03RF will be erased)
- Press the "SET" button (set / learn) for about 3 sec. until the orange LED_2 starts flashing slowly and continuously: Receiver is now in learning mode
- The receiver stays max. 25 minutes in learning mode. If no learning telegram from REV23.03RF is received during that period of time, repeat steps b) and c) again
- Press the ESC button  on REV23.03RF for about 4 seconds. Learning telegram is transmitted
- If REV-R.03/1 receives learning telegram, the orange LED_2 flashes fast and briefly
- If the orange LED_2 is steady on, the relay is energized (= controlled device ON)
- If the orange LED_2 is dark, the relay is deenergized (= controlled device OFF)
- Depending on the operating state, REV23.03RF repeats the ON or OFF control telegram every 3 minutes. With this the relay will be switched ON or OFF according to control telegram latest after 3 minutes
- If REV-R.03/1 does not receive any correct control telegram within 60 minutes, controlled device is being switched off and LED_1 flashes in red
- In the event of a power failure at the REV-R.03/1, the relay will be deenergized.

4. Site REV23.03RF

- Site REV23.03RF at preferred location for mounting at wall or setting up with stand
- Also refer to "Mounting and siting notes REV23.03RF and REV-R.03/1"

5. Find location of best RF reception

- Switch off power at REV-R.03/1
- Switch on REV23.03RF, site at preferred location and press override button  for about 4 seconds: REV23.03RF transmits test telegrams every 2 seconds. Transmission of test telegrams stops automatically after 10 minutes or after pressing either "ESC" button or override button
- Switch on power at REV-R.03/1
- Observe both LEDs on REV-R.03/1 from a distance of 2...3 meters
- Orange LED_2 must flash briefly every 2 seconds. If LED_2 does not flash every 2 seconds, distance between REV23.03RF and REV-R.03/1 is too far. Mount REV-R.03/1 closer to REV23.03RF
- LED_1 shows received signal strength of last telegram:
 LED_1 flashes red: Signal is too weak to get a durable link. Mount REV-R.03/1 closer to REV23.03RF
 LED_1 flashes green: We distinguish between three signal strengths:
 Very good (flashes 3x), Good (flashes 2x) and Satisfactory (flashes 1x).
 As soon as LED_1 flashes in green, link between REV23.03RF and REV-R.03/1 is basically ok.
- Move REV-R.03/1 within an area of approximately 1 square meter to find location of best RF reception. Always observe LEDs from a distance of 2...3 meters. To get a durable link, we recommend to site REV-R.03/1 at a location where signal strength is at least "Good".

6. Explanations to LEDs

LED_1 lights always in red

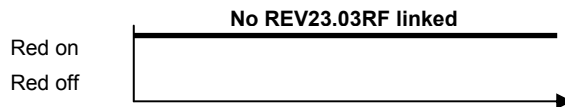

LED_1 flashes in red

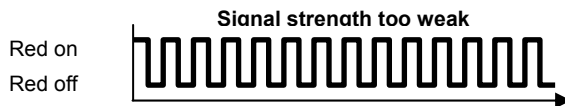

LED_1 flashes 3 times in green

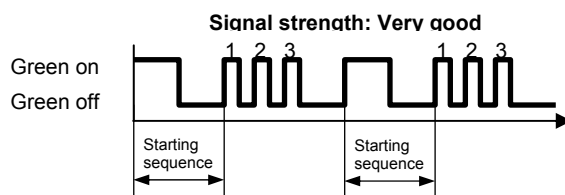

LED_1 flashes 2 times in green

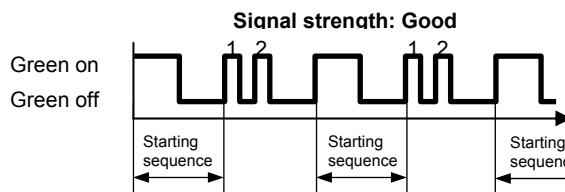

LED_1 flashes 1 time in green

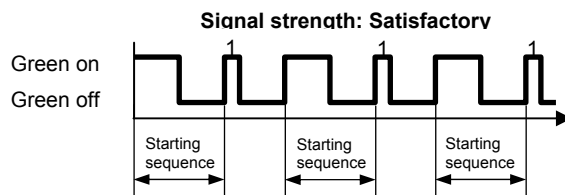

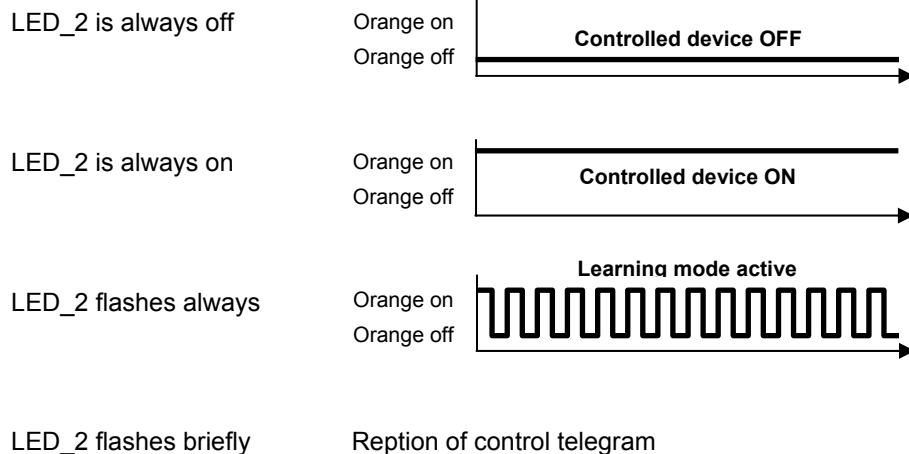

7. Finishing mounting of REV-R.03/1

- Switch off power
- Mark location where REV-R.03/1 is currently fixed
- If necessary loosen wiring
- Mount receiver at location marked before, wire completely and close housing
- Switch on mains power

Notes

- In the event of a power failure at the REV-R.03/1, the relay will be deenergized.
- If in normal operation REV-R.03/1 does receive for more than 25 minutes a very weak or no control telegram from REV23.03RF, LED_1 starts to flash in red. If control telegram is still understood correctly, receiver continues with normal operation. If control telegram is not understood anymore, relay remains in last position being switched to before. As soon as REV-R.03/1 does receive any correct control telegram from REV23.03RF again, receiver continuous with normal operation
- In case of error, REV-R.03/1 switches off relay approximately 60 minutes after reption of last correct control telegram. The controlled device is also switched off and LED_1 flashes in red. As soon as REV-R.03/1 does receive any correct control telegram from REV23.03RF again, receiver continuous with normal operation

Commissioning controller/transmitter REV23RF (previous model) and receiver REV-R.03/1



- If instead of REV23.03RF the previous model REV23RF shall be linked with REV-R.03/1, follow the procedure below:
 - Follow steps 1 ... 3b (same as commissioning with REV23.03RF)
 - Instead of step 3c, press buttons SET and RESET simultaneously for approximately 3 seconds until orange LED_2 starts flashing slowly and continuously: Receiver is now in learning mode for previous controller type REV23RF
 - Change temperature setpoints at REV23RF to force transmission of a control telegram: As soon as orange LED_2 flashes fast and shortly REV23RF and REV-R.03/1 are linked together
 - If the orange LED_2 is steady on, the relay is energized (= controlled device ON)
 - If the orange LED_2 is dark, the relay is deenergized (= controlled device OFF)
 - Continue to step 7

Technical data controller / transmitter REV23.03RF

General data controller / transmitter	Operating voltage	DC 3 V
	Batteries (alkaline AA)	2 x 1.5 V
	Battery life	approx. 2 years
	Backup for battery change	max. 1 min
General data controller	Sensing element NTC	NTC 10 k Ω at 25 °C \pm 1 %
	Measuring range	0...50 °C
	Time constant	max. 10 min
	Setpoint setting ranges	
	Normal temperature	5 ... 29 °C
	Economy temperature	5 ... 29 °C
	Frost protection setpoint	
	Setting range	5...29 °C
	Factory setting	5 °C
	Resolutions of settings and display	
General data transmitter	Setpoints	0.2 °C
	Switching times	10 min
	Measurement of actual value	0.1 °C
	Display of actual value	0.2 °C
	Display of time	1 min
	SRD band	868.7 to 869.2 MHz
	Transmit frequency REV23.03RF	868.95 MHz
	Max. transmitter power	< 10 mW / typically 4 mW
	Max. data throughput	19200 symbol/s = 38400 Bit/s
	Modulation	binary frequency changeover BFSK
Frequency stability	< \pm 20 ppm (\pm 17 kHz)	
Address range	16 Bit (0...65535)	
	(preset in the factory)	
Environmental conditions	Operation	to IEC 60 721-3
	Climatic conditions	class 3K3
	Temperature	5...+40 °C
	Humidity	<85 % r. h.
	Transport	to IEC 60 721-3
	Climatic conditions	class 2K3
	Temperature	-25...+70 °C
	Humidity	<93 % r. h.
Norms and standards	Mechanical conditions	class 2M2
	CE conformity	
	EMC directive	89/336/EEC
	R&TTE directive	EN 301 489-3
	Product safety	
	Radio equipment	EN 301 489-3
	Automatic electrical controls for household and similar use	EN 60 730-1
	Electromagnetic compatibility	
	Immunity	EN 61 000-6-1
	Emissions	EN 61 000-6-3
Radio equipment	EN 300 220-3	
Approvals	CE 0359 ①	
In the following countries	all ECC countries, Norway, Iceland and Switzerland	

Devices of safety class	II to EN 60 730-1	
Degree of pollution	normal	
Weight (incl. package)		
	REV23.03RF	0.37 kg
	REV23RF/SET	0.68 kg
Color		
Housing	signal-white RAL 9003	
Base	grey RAL 7038	
Dimensions	140x103x30 mm	

Technical data receiver REV-R.03/1

General unit data	Operating voltage	AC 230 V +10/-15 %
	Power	< 10 VA
	Frequency	45...65 Hz
	Switching capacity of relays	
	Voltage	AC 24...250 V
	Current	6 (2.5) A
Environmental conditions	Operation	to IEC 60 721-3
	Climatic conditions	class 3K3
	Temperature	0...+45 °C
	Humidity	<85 % r. h.
	Storage and transport	to IEC 60 721-3
	Climatic conditions	class 2K3
	Temperature	-25...+70 °C
	Humidity	<93 % r. h.
	Mechanical conditions	class 2M2
Norms and standards	 conformity	
	EMC directives	89/336/EEC
	Low-voltage directives	73/23/EEC
	R&TTE directives	EN 301 489-3
	Product safety	
	Radio equipment	EN 301 489-3
	Automatic electrical controls for household and similar use	EN 60 730-1
	Special requirements placed on energy controllers	EN 60 730-2-11
	Electromagnetic compatibility	
	Immunity	EN 61 000-6-1
	Emissions	EN 61 000-6-3
	Radio equipment	EN 300 220-3
	Approval	 0359 ⓘ
	In the following countries	all ECC countries, Norway, Iceland and Switzerland
	Devices of safety class	II to EN 60 730-1
	Degree of pollution	normal
	Weight (incl. package)	
		REV-R.03/1
	REV23RF/SET	0.68 kg
Color		
Unit front	Signal-white RAL 9003	
Base	grey RAL 7038	
Dimensions	83x104x32 mm	

Connection diagram receiver REV-R.03/1

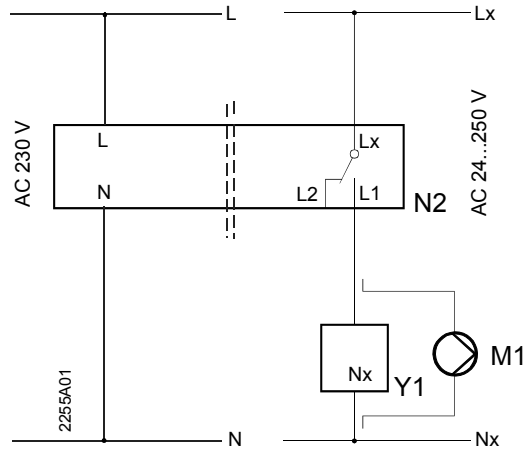

- L Live conductor, AC 230 V
- N Neutral conductor, AC 230 V
- Lx Live, AC 24...250 V
- L1 N.O. contact, AC 24...250 V / 6 (2.5) A
- L2 N.C. contact, AC 24...250 V / 6 (2.5) A
- M1 Circulating pump
- N2 Receiver REV-R.03/1
- Y1 Actuating device

Application examples

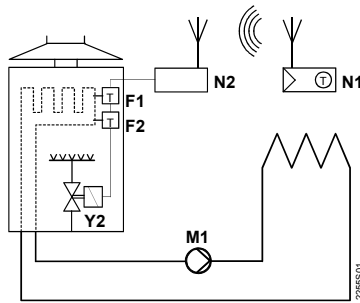

Instantaneous hot water heater

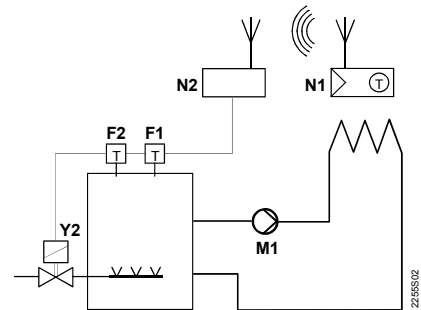

Atmospheric gas burner

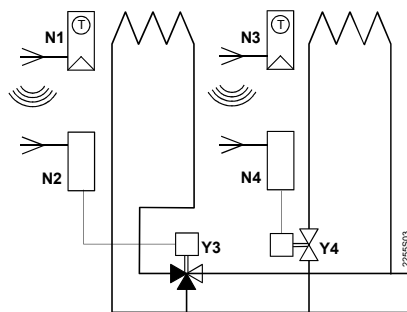

Zone valve

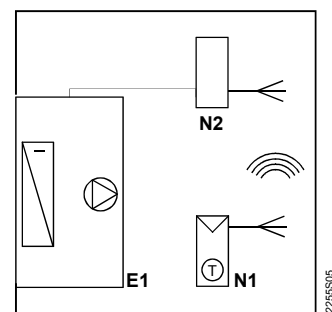

Cooling equipment

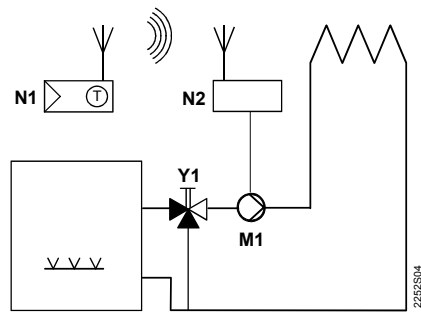

Circulating pump with precontrol by manual mixing valve

- E1 Cooling unit
- F1 Thermal reset limit thermostat
- F2 Safety limit thermostat
- M1 Circulating pump
- N1 Room temperature controller (transmitter) REV23.03RF
- N2 Receiver REV-R.03/1
- N3 Room temperature controller (transmitter) REV23.03RF
- N4 Receiver REV-R.03/1
- Y1 3-port valve with manual adjustment
- Y2 Solenoid valve
- Y3 Motorized 3-port valve
- Y4 Motorized 2-port valve

Dimensions

Controller / transmitter REV23.03RF

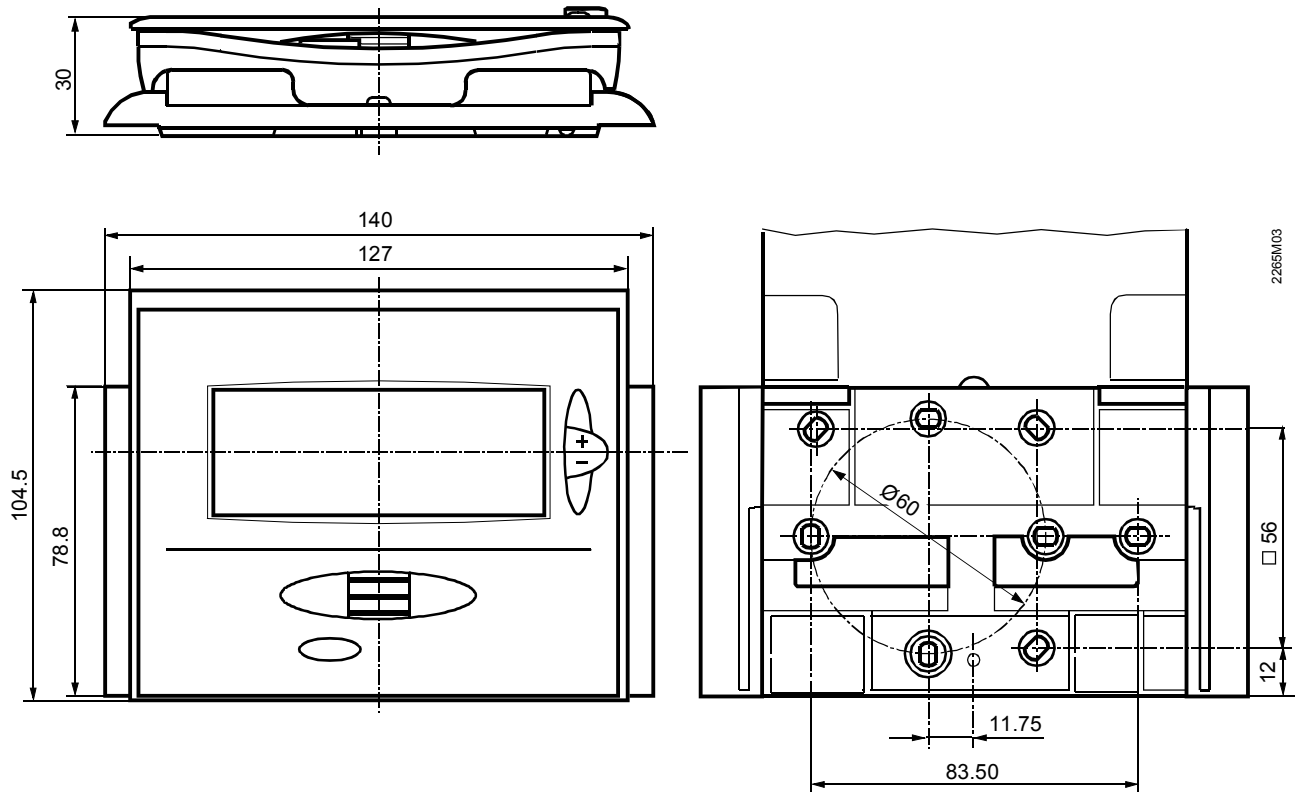

Receiver REV-R.03/1

