



Room Temperature Controller

REV100

with touch screen

- **Mains-independent room temperature controller**
- **Self-explanatory touch screen**
- **Self-learning two-position controller with PID control (patented)**
- **Choice of two different 24-hour operating modes**

Use

For the control of the room temperature in

- apartments, single-family or holiday houses
- offices, individual rooms and consulting rooms or commercially used spaces

For the control of the following pieces of equipment:

- Solenoid valves of instantaneous water heaters
- Solenoid valves of atmospheric gas burners
- Heating circulating pumps, zone valves (normally closed)
- Electric direct heating systems or fans of electric storage heaters

Functions

- PID control with self-learning or selectable switching cycle
- Two different 24-hour operating modes
- Remote control and override button
- Sensor balancing and reset function
- Locking of display to facilitate cleaning or to prevent tampering
- Frost protection function and minimum limitation of the setpoint

Type summary

Room temperature controller with 24-hour time switch

REV100

Ordering and delivery

When ordering, please give type reference according to "Type summary".
The unit is supplied complete with batteries.

Mechanical design

Plastic casing with a large display which also serves as a touch screen. A hinged battery compartment cover facilitates the straightforward exchange of the two 1.5 V alkaline batteries type AA. The base can be removed and fitted to all commercially available recessed conduit boxes or directly on the wall, to be wired before the controller is fitted. The casing accommodates the electronics with a **DIP** switch and a relay with a potential-free N.O. contact. The connection terminals are integrated in the base.

Display and operating elements

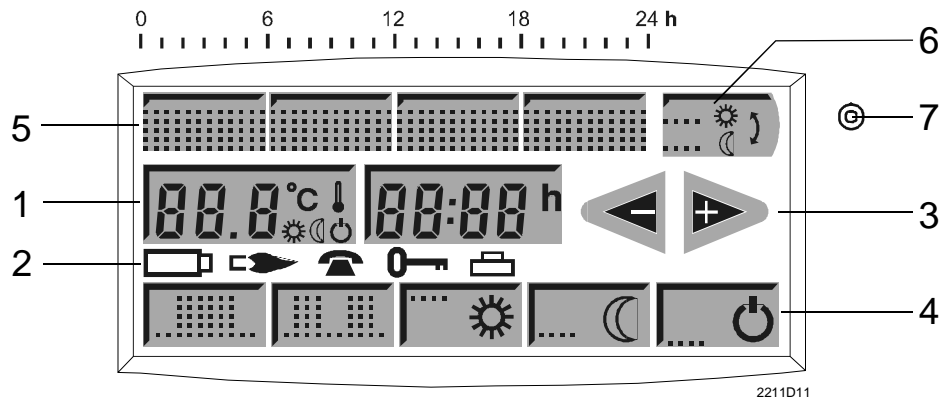

- 1 Display buttons
 - Temperature values and symbols
 - Normal temperature
 - Economy temperature
 - Standby with frost protection
- 2 Symbols
 - Time of day or switching time
 - Change batteries
 - Burner in operation
 - Remote control active
 - Locking of display active
 - Holiday program active
- 3 Arrow buttons
 - Increasing / decreasing values
- 4 Operating mode buttons
 - 24-hour operation with one heating period
 - 24-hour operation with two heating periods
 - Continuously normal temperature
 - Continuously economy temperature
 - Standby with frost protection
- 5 Switching time buttons
 - For the switching times 1 to 4
- 6 Level button
 - For switching manually from normal to economy temperature, or vice versa
- 7 Locking / reset
 - Opening for locking the display or for the reset

Display button function

Not highlighted and no symbol: function cannot be selected.

17:02 h Highlighted / symbol visible: function can be selected but is not yet activated.

17:02 h Highlighted / symbol / angle bar visible at top left: function is activated.

Automatic storage

When an adjustable display button is pressed, the displayed value will automatically be stored 5 seconds later and the previous operating mode will be resumed or reactivated.

Adjusting the values

Pressing one of these buttons for less than one second produces a step of one minute (time settings) or of 0.2 °C (temperature settings).

Pressing for more than one second means quick adjustment which can be cancelled again by pressing the button repeatedly.

Setpoints

| | Standard value | Setting range | Setting range with setpoint limitation |
|--|----------------|---------------|--|
| | 20 °C | 3...29 °C | 16...29 °C |
| | 16 °C | 3...29 °C | 16...29 °C |
| | 5 °C | 3...16 °C | 3...16 °C |

The setpoints of and are identical in both 24-hour operating modes.

Adjusting the setpoints

16.0 °C Press the temperature button and then the required operating mode button.

. Press to adjust the setpoint temperature of each operating mode.

Warmer / colder

16.0 °C Press the temperature button and then to readjust the displayed temperature in increments of 0.2 °C (max. ±4 °C) to the room temperature temporarily required. The warmer / colder function can be applied to all three temperature setpoints, but the values thus changed will be reset again when the next switching point is reached.

Setting the time of day

12:00 h Press the time button and then to set the correct time of day.

Switching points

The two switching points for the 24-hour operation with one heating period and the four switching points for the 24-hour operation with two heating periods can be entered individually and independently.

Standard values

| Operating mode | Switching point 1 | Switching point 2 | Switching point 3 | Switching point 4 |
|----------------|-------------------|-------------------|-------------------|-------------------|
| | 06:00 | 09:00 | 17:00 | 22:00 |
| | 07:00 | 23:00 | | |

Changing the switching points

Press or and select the individual switching points by pressing the respective switching time button . Then, change the displayed switching time by pressing .

- If two switching times coincide on the same switching time button, the display alternates between the two switching points when pressing the button repeatedly

Override button



Manual changeover from the normal to the economy temperature, or vice versa. The selection will automatically be reset when the next switching point is reached or when changing the operating mode.

Manual changeover to the normal temperature is active

Manual changeover to the economy temperature is active

Holiday program

When absent for a longer period of time, it is possible to switch manually to the economy temperature and to enter the period of absence.

Enter Select the economy temperature  and press the time button, then enter the number of days you are absent  (max. 99 days). The display will show the number of days and the holiday symbol. Every midnight, the counter subtracts one day. When the day counter reaches 00, the 24-hour operation with two heating phases will automatically be resumed.

Cancel Press the day counter and set it to 00.

Sensor calibration If the temperature displayed does not agree with the room temperature effectively measured, the temperature sensor can be re-calibrated. For that purpose, set the DIP switch for Sensor Alignment to ON and press the DIP switch button.

Press  to bring the flashing room temperature in line with the room temperature currently measured. The increments for the readjustment are 0.2°C {max. ±2 °C}. When balancing of the sensor is completed, the DIP switch must be reset to OFF.



Locking the display Before cleaning the display or to prevent tampering, the display buttons can be locked.

Switching on Press the button behind the little hole for a short moment (max. 1 second):  appears and all other displays disappear. The display buttons are now disabled while all the other functions are fully maintained.

Switching off Press the button behind the little hole again (max. 1 second).

Reset Keep the button behind the little hole depressed for at least 3 seconds. This resets the individual settings and the time of day to their default values. During the reset time of 3 seconds, the display will be fully lit, allowing the proper functioning of the display to be checked. After each reset, all personal settings such as time of day, weekday, switching points, temperature setpoints, sensor calibration, etc., must be re-entered.

Battery change About three months before the batteries are exhausted, the display shows the battery symbol . The other displays disappear, the display buttons are deactivated while all the other functions are fully maintained. When changing the batteries, the current data will remain stored for at least one minute.

Remote control Using a suitable remote operating unit, the REV100 can be switched to economy mode . Changeover takes place by closing a **potential-free contact** connected to terminals T1 and T2. In that case, symbol  appears on the display. When the contact opens, the selected operating mode will be reactivated.

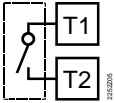
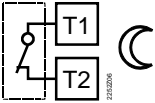
| Operation according to controller setting | Continuous economy temperature |
|---|---|
|  |  |

Remote operating units Suitable remote operating units: telephone modem, manual switch, window switch, occupancy detector, control centre, etc.

DIP Switch

| | | | | |
|--|--------------------------|--------------------------|--------------------------|--------------------------|
| ☀ 3...29°C | <input type="checkbox"/> | | | |
| ☀ 16...29°C | <input type="checkbox"/> | | | |
| Self learning | | <input type="checkbox"/> | <input type="checkbox"/> | |
| PID 12 | | <input type="checkbox"/> | <input type="checkbox"/> | |
| PID 6 | | <input type="checkbox"/> | <input type="checkbox"/> | |
| 2-Pt  | | <input type="checkbox"/> | <input type="checkbox"/> | |
| Sensor Alignment | | | | <input type="checkbox"/> |
| Disable | | | | <input type="checkbox"/> |
| Enable | | | | <input type="checkbox"/> |
| | 1 | 2 | 3 | 4 |

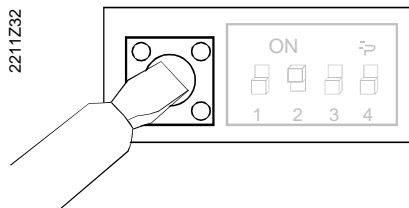

Every Dip switch setting must be confirmed by pressing the Dip switch button.

Setpoint limitation

Minimum limitation of the setpoint to 16 °C in buildings with several heating zones prevents heat from being transferred from one apartment to another. The function can be selected with the **DIP** switch.

Control

The REV100 is a two-position controller providing PID mode. The room temperature is controlled by the cyclic switching of a regulating unit.

Self-learning mode

The controller comes with an activated self-learning operating mode, which means that it automatically adapts to the type of controlled system (type of building construction, type of radiator, size of room, etc.). On completion of a certain learning phase, the controller automatically optimizes its parameters and then operates based on the mode learned.

Exceptions

In exceptional cases where the self-learning mode does not represent the optimum solution, it is possible to choose PID 12, PID 6 or the two-position mode.

- PID 12 mode 12-minute switching cycle for normal to slow controlled systems (e.g. massive houses, larger spaces, cast iron radiators, oil burner)
- PID 6 mode 6-minute switching cycle for fast controlled systems (e.g. light building structures, small rooms, plate radiators / convectors, gas burner)
- 2-Pt mode Pure two-position controller with a switching differential of 0.5 °C (± 0.25 °C) for very difficult controlled systems with extreme outside temperature variations

Technical data

| | | |
|-------------------------------|-----------------------------------|--------------------------------------|
| General unit data | Operating voltage | DC 3 V |
| | Batteries (alkaline AA) 2 x 1.5 V | 2 x 1.5 V |
| | Life | approx. 3 years |
| | Backup for battery change | max. 1 min |
| | Switching capacity of relays | |
| | Voltage | AC 24...250 V |
| | Current | 8 (3.5) A |
| | Sensing element | |
| | Measurement range | 0...40 °C |
| | Time constant | max. 10 min |
| | Setpoint setting range | |
| | Normal temperature | 3...29 °C |
| | Economy temperature | 3...29 °C |
| | Frost protection temperature | 3...16 °C |
| | Norms and standards | Resolutions of settings and displays |
| Setpoints | | 0.2 °C |
| Switching times | | 10 min |
| Measurement of actual value | | 0.1 °C |
| Display of actual value | | 0.2 °C |
| Display of time | | 1 min |
| CE conformity | | |
| Electromagnetic compatibility | | 89/336/EEC |
| Low voltage directive | | 73/23/EEC |
| Electromagnetic compatibility | | |
| Immunity | | EN 50 082-2 |
| Emissions | | EN 50 081-1 |
| Safety class | | II to EN 60 730-1 |
| Degree of protection | | IP30 to EN 60 529 |
| Environmental conditions | | Perm. ambient temperature |
| | Operation | 3...35 °C |
| | Storage and transport | -25...+60 °C |
| | Perm. ambient humidity | G to DIN 40 040 |
| Weight | Incl. packing | 0.3 kg |
| Colour | Casing signal | signal-white RAL9003 |
| | Base | grey RAL7038 |
| Seize | Housing | 120 x 98 x 31 mm |

Notes

Engineering

- The room temperature controller should be fitted in the main living room
- The place of installation should be chosen so that the sensor can capture the room temperature as accurately as possible without getting adversely affected by direct solar radiation or other heating or refrigeration sources
- Mounting height is approximately 1.5 m above the floor
- The unit can be fitted to most commercially available recessed conduit boxes or directly on the wall

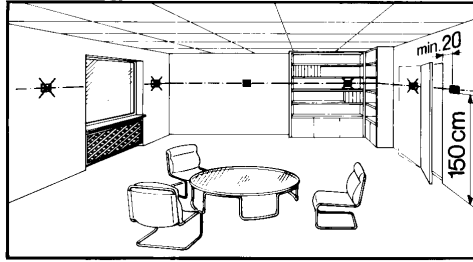

Mounting and installation

- When installing the controller, the base must first be fitted and wired. Then, the unit can be engaged at the top, swung downward and snapped on
- For more detailed information, refer to the installation instructions supplied with the unit
- For the electrical installation, the local safety regulations and standards must be complied with
- The remote control contact T1/ T2 must be wired separately, using a shielded cable

Commissioning

- The battery transit tab, which prevents inadvertent operation of the unit during transport and storage, must be removed
- The control characteristic can be changed with the DIP switch located at the rear of the unit
- If the reference room is equipped with thermostatic radiator valves, they must be set to the fully open position
- If the room temperature displayed does not agree with the measured temperature, the sensor should be re-calibrated (refer to section "Calibration of sensor").

Connection diagram

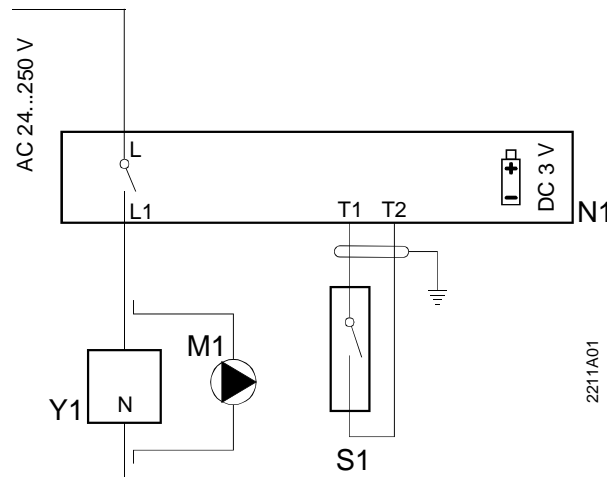

| | | | |
|----|---|----|--|
| L | Live, AC 24 ... 250 V | S1 | Remote operating unit (potential-free) |
| L1 | N.O. contact, AC 24 ... 250 V / 8 (3.5) A | T1 | Remote control signal |
| M1 | Circulating pump | T2 | Remote control signal |
| N1 | REV100 controller | Y1 | Regulating unit |

Application examples

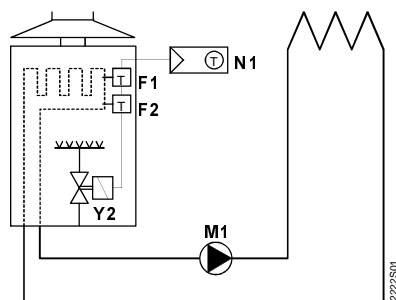

Instantaneous water heater

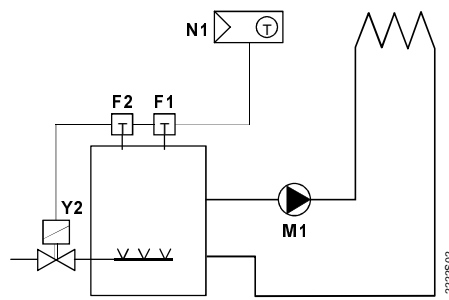

Atmospheric gas burner

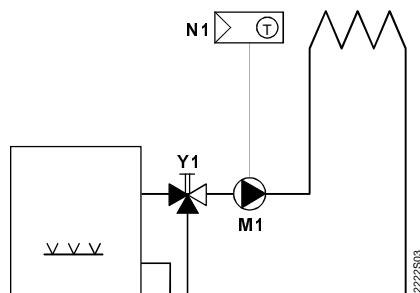

Circulating pump with pre-control by manual mixing valve

| | | | |
|----|--------------------------------------|----|--------------------------------------|
| F1 | Thermal reset limit thermostat | N1 | REV11... room temperature controller |
| F2 | Manual reset safety limit thermostat | Y1 | Manually operated three-port valve |
| M1 | Circulating pump | Y2 | Solenoid valve |

Dimensions

